

*"I have a dream. ."* the Governor said,  
*"but it is not the impossible dream~"*

But it was

*The  
Impossible  
Dream*

*by* K.M.Heaton

*Dedicated to the memory  
of the life and work of*



*Patriot  
Jo Hindman*

*Folio number Forty two*

# *"the impossible dream~"*



The preservation of a free government requires, not merely that the metes and bounds which separate each department of power be invariably maintained, but more especially that neither of them be suffered to overleap the great barrier which defends the rights of the people.

The rulers who are guilty of such encroachment exceed the commission from which they derive their authority, and are tyrants. The people who submit to it are governed by laws made neither by themselves nor by an authority derived from them and are slaves.

It is proper to take alarm at the first experiment upon our liberties—we hold this prudent jealousy to be the first duty of citizens, and one of the noblest characteristics of the late Revolution. The freemen of America did not wait till usurped power had strengthened itself by exercise, and entangled the question in precedents. They saw all the consequences in the principle, and they avoided the consequences by denying the principle.

JAMES MADISON



G1990

*by* K.M.Heaton

John Hart Reference Library  
1333 Lincoln St. #289  
Bellingham, WA 98226

## "THE IMPOSSIBLE DREAM"

### Foreword

1  
**rev-olu-tion:**

2 a : a sudden, radical, or complete change b : a fundamental change in political organization: esp : the overthrow or renunciation of one government or ruler and the substitution of another by the governed c : activity or movement designed to effect fundamental changes in the socioeconomic situation (as of a racial or cultural segment of the population) *syn* see REBELLION

This book is about an elitist dream as old as Plato - a dream of power. Power, stolen from those in whom it was vested in the beginning, and transferred to self-appointed would-be rulers of the world. But it is much more than that.

It is about the strategies being used to transfer that power. But it is much more than that, too. It is about sedition and conspiracy, but more than that, too.

It is about the basic who, what, when, why, where and especially how, of a non-military assault against lawful conduct of public affairs, carried on under the cover of a seemingly voluntary change in the way the government of the United States operates. But it is more than that, too.

This book is about revolution - for any fundamental change in the way a nation is governed IS revolution. That this IS revolution is a recognized fact in the working papers of those who are in charge of the changes demanded by the revolutionary Goal.

This book is about the methods being used to bring about that Goal. It is particularly about means to counter that revolution.

There is a growing body of Americans who have become aware that their future is threatened by a monstrous evil abroad in the world. Lacking knowledge of the hidden agenda, they are firing at the visible evidence of it, but they are not touching the cause of that evil.

There is also a growing segment of the American people who think it is too late to do anything about it.

NO ONE except the Lord, Himself, knows when it is too late. While there is even a remnant of resistance still able to function, the final curtain has not fallen.

Unless and until every human being, and all the assets of this world, are under complete control of the revolutionaries, this unholy war is still not over. Maybe it won't be even then, while any spark of liberty still burns in the hearts of the conquered.

There may be a real difference in concept of things known, which brings to the facts an altered perspective. In my opinion, that is the key to turning back the red tide now inundating the world, and was the determining factor in the articles selected for inclusion in this report on "The Impossible Dream".

Concept may also be the key reason why, until now, there has

not been any demonstrable success in the heroic efforts which have been made to interdict this assault on civilization in the past.

Hopefully, exploring the strategies which have advanced this revolution will trigger original thinking about future offensive moves.

While this book is primarily targetted for activist resisters already in the field, the consummate tragedy of today is that there is a great majority of the American public who do not have the vaguest idea of what is planned for their futures. What an army they could be, if they but knew what is in this book!

Those who have locked horns in the past with the perpetrators of such crimes against humanity, against nature, and nature's God are a minute fraction of those who should, could, and would, resist, if they had an inkling of what the future holds - unless there is such resistance. What has gone before is but a prelude to the reality which lies ahead, unless this revolution is stopped.

An important strategy the revolutionaries have used to achieve an altered public concept has been the unreported redefinition of familiar terms.

'Democracy' is one of the altered perceptions which have allowed the progress of this revolution. The Founding Fathers of these United States knew full well, and expounded on, the nature of democracy, and were explicit in denial of a democratic form of government for the nation being formed. They gave us a Republic, "if we could keep it" - which we haven't done too well in recent years. In large part, this is due to the role assigned to "democracy" by the revolutionaries.

"Revolution" itself is another term which has been redefined. In the minds of most Americans, revolution immediately brings to mind the heroic struggle which resulted in creation of the United States of America, or, alternatively, the bloody coups in Russia. Modern dictionaries (as above) suggest that any change in political form is revolution, even with the consent of the governed. Historically, revolution indicated overthrow of a government, without lawful process.

The revolution now taking place is of the redefined genre. It is rarely violent (as of 1990), and is being conducted at this stage within the halls of government, itself. A basic strategy is the achievement of an apparent 'consent of the governed'.

Recognition that this IS revolution, and that there is no valid 'consent' are of the essence, if there is to be a stop put to it.

These pages are mainly composed of articles written by me, which appeared in a number of independent newspapers, and/or "reports" over a period of years. Most of my columns were prompted by some current event, which I considered had special significance. Some, though, were written to call attention to previously neglected, or hidden, acts of subversion.

Some columns had a timely aspect, which no longer has

meaning. In such a case, if the remainder of the article is pertinent to this work, modified versions are included. In some cases, updates are added, where a showing of continuity seemed needed.

All of my work is supported either by original research, or by personal experience - frequently, by both. While some of the facts may be familiar territory to some of you, I early learned that there is no substitute for exploring the fountainhead from which current events have sprung. Often, the facts are the least product of my research. Far too often, seminal evidence is present at the source which, had it been properly evaluated, could have been a lodestar for resistance, then, before these events became accomplished fact.

Much of that evidence exists in the strategies which have been devised to support the revolutionary moves. It is my conviction that successful interdiction of this revolution must come in the strategic arena, destroying the process, before the objective is attained. For those areas already conquered, new strategies must be developed.

Be advised, that what is presented here is a miniscule portion of the enemy arsenal. It is exemplary, not comprehensive.

Throughout these pages, whenever it is necessary to use one of the terms which now have definitions other than those historically understood, they are put between single quote marks (' '). Some of these are defined at the end of the chapter in which they first appear. Some are not because the meaning is evident. Where such a word is used in its historical sense, it is not marked.

Another perception which has been encouraged as a revolutionary tactic has to do with the GOAL of this revolution.

Hairs have been split over patriotic resistance to 'socialism' and/or 'communism', both which have been perceived as an apparent goal of this worldwide revolution. More real than apparent is the true goal - evidenced in every revolutionary move, implicit in every program promoted, actualized in every conquered land, and explicitly stated in early documents directly attributable to the mattoids who dreamed this "impossible dream".

That true goal is a return to feudalism, with the revolutionaries in total control of all the resources of the world - including what they have identified as "human resources". (See GEB statement, "Document Section")

Since the communist/socialist smokescreen blurred my own vision for many years, I have nothing but empathy for those who haven't yet broken through the obfuscation.

With this introduction, and a prayer that this book will fulfill its intended function, let's get to it.

K. M. Heaton, 1990  



A Speech delivered at a Public Dinner in the City of Washington, on the 22d of February, 1832, that being the Centennial Anniversary of Washington's Birth-Day.

Other misfortunes may be borne, or their effects overcome. If disastrous war should sweep our commerce from the ocean, another generation may renew it; if it exhaust our treasury, future industry may replenish it; if it desolate and lay waste our fields, still, under a new cultivation, they will grow green again; and ripen to future harvests. It were but a trifle even if the walls of yonder Capitol were to crumble, if its lofty pillars should fall, and its gorgeous decorations be all covered by the dust of the valley. All these might be rebuilt. But who shall reconstruct the fabric of demolished government? Who shall rear again the well-proportioned columns of constitutional liberty? Who shall frame together the skilful architecture which unites national sovereignty with State rights, individual security, and public prosperity? No, if these columns fall, they will be raised not again. Like the Coliseum and the Parthenon; they will be destined to a mournful, a melancholy immortality. Bitterer tears, however, will flow over them, than were ever shed over the monuments of Roman or Grecian art; for they will be the remnants of a more glorious edifice than Greece or Rome ever saw, the edifice of constitutional American liberty.

*Daniel Webster*

DANIEL WEBSTER.

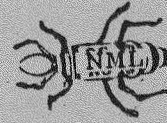
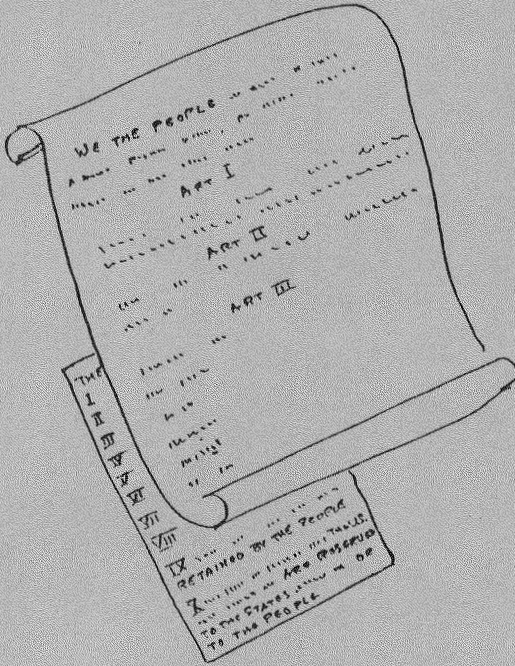
# section I



## The Past Is Prologue

ch:	pa:
1 A World in Chaos	I - 1
2 The Affairs of Men	I - 3
3 The Impossible Dream	I - 5
4 The Germ of Corruption	I - 7
5 A Yardstick for Truth	I - 9
6 A Guide to Crisis	I - 11
7 Socialism or Empire?	I - 13
8 The Gas Crunch	I - 15
9 The Little Green Bus	I - 18
10 No Need to Know?	I - 20
11 It Doesn't Make Sense	I - 23





History is a story of the lives of men.

Sometimes a single life makes a never-to-be forgotten mark on a short span of time. More often, the works of many lives are strung together through the years, carving a recognizable, continuing path to destiny. Sometimes lives are intertwined, leaving a definite pattern as they move through time. Sometimes lives parallel each other; sometimes paths cross.

The lives, themselves, however, would leave no impression on history, but for the impact they have on time. This ability to impact is one element which separates man from the lower animals - an important factor in denial of the theory of evolution. All the animals which have existed since time began, singly or in concert, have made no imprint on the course of history or time. A single man can, and often does.

Whether that impact is good or evil is not a matter of judgement. Even were there no decalogue, no gospel, there is a scale on which to weigh the actions of men. That scale exists in the laws of nature, and every normal-born person is equipped with an interface with nature's universal laws.

Man's measuring device is called "conscience".

The capability of recognizing violations of nature's laws held man on course before writing was developed. From the beginning, that course, as a general rule, was upward - out of ignorance and the earth-earthy life of physical dominance, to knowledge and mental dominance.

Natural law was implicit in the Ten Commandments and in the precepts of Christ, as well as in the teachings of all religious leaders of heroic stature. When operative, natural law leads to peace, progress and prosperity.

In nature's system of law, it is not intent which is the determinant of good and evil. It is, rather, how an act affects nature itself.

It is a practical impossibility for one man's mind to determine the intent of the mind of another. If an act violates natural law, it is evil, no matter the intent.

This is the scale on which the actions of those who accept or assume power and authority must be weighed. Violation of natural law results in corruption, confusion and chaos, and the results identify the nature of the act.

The Golden Rule, a natural law, expressed in such thoughts as "Do unto others as you would have others do unto you" and "As I would not be a slave, so I would not be a master", extends individual values beyond self to all mankind. To some, this Rule is a lodestar, lighting their path. To others, it is a still, small voice, easily overlooked - usually just when most needed.

Not only is there natural law, there is also its opposite. Both have magnetic pull. Character is built by resistance. If the resistance is to natural law, the ability to resist evil decreases with each offense against nature, strengthening immorality. When the resistance is to un-natural law (as is the case when a firm stand is taken with conscience), strong, moral character results, gaining strength with each encounter.

Viewing the state of the world today in the light of the lives of those who have taken leading roles in the resistance to natural law, the immensity of the evil growing by what it feeds on is only too evident.

It is not anarchy holding sway today, it is chaos - the inevitable

result of resistance to natural law. Men with power, succumbing to the pull of un-natural law - each past, lesser evil numbing conscience a little more, the accumulated amorality widening the gap between them and conscience. Their perfidy is contagious. It pollutes the morals, character and conscience of all who are drawn into their schemes, It can even taint the lives of nonparticipants.

The tragedy so visibly engulfing the world today did not 'just happen' It is the natural outcome of the actions of a comparative handful of conscienceless men, aided and abetted by hordes of greedy collaborators.

One of the saddest aspects of the results of their treachery is that this tragedy was made possible by the miracle of a country built on the premise of adherence to natural law.

Without the progress of civilization which resulted from the United States of America being placed under the control of a Constitution constructed on natural law, and the leadership of men of conscience who developed the means to permit natural law to be operative, the freedom to wilfully exercise un-natural law would have been severely circumscribed.

The only possibility of reversing the reign of terror so palpably ahead lies in recognition by those still in tune with natural law that resistance to the planned destruction of individual and national sovereignty must be active, and of equal or better force than that supporting un-natural law and usurped dominion.

Those who have opted out of this struggle between good and evil do not recognize that, by nonresistance, they have taken their own first step against natural law, and opened the way to further depredation, which will not only impact these times - and all time to come - but, inevitably, their own immortal souls.

It is with the hope that the information presented here will fortify the present resistance, restore incentive to the disheartened, and stimulate renewed determination to neutralize the evil forces now usurping the rights of all mankind, that this information is being offered.

Since time began, part of Man's endowment from his Creator has been an insistent urge toward bettering himself. Born with original sin, and given free choice, the majority throughout history have taken the path which leads to improvement. This innate urging brought Man from the caves which were his first dwellings, to the skyscrapers of today - and everything in between.

Whenever the majority have neglected this urge, the result has been, at best, chaos - at worst, regression.

It was this urge which led Man from lonely prowling of the fields or jungles for food and shelter, to join his fellowmen in primitive forms of governing. From tribal situations to more structured cooperation (as evidenced in Mesopotamia and Egypt), and on to the definitive governments of Greece and Rome, this creative urge undergirded progress.

Through the "dark ages" to the bright hope of the cultural, scientific and industrial advances realized by the creation of the United States of America, Man made most progress when this urge was least impeded, internally, or by outside forces.

It is a perversion of that natural urge which prompts the 'rulers' (and the would-be rulers) of the world to increase their pelf and power, by usurping their unalienable birthright of liberty from those they can control.

When knighthood was in flower, despite song and story, mankind, in general, was in servitude. The knights, their ladies, the kings and queens, the feudal lords - all enjoyed their luxuries at the cost of the blood, sweat and tears of the "human resources" which supplied their wants. In return for serving their lieges, the minions were permitted to live, and to feast on the crumbs from the full tables of their masters.

History is a record of the unceasing struggle between Man, yearning to be free, and Might, determined to control that freedom. The chess game played by those who proclaim a "divine right" over their fellowmen, has left rivers of blood on every continent, and that chessgame goes on today. The combines which operated in days of old downplayed the suffering of "the peasants", who were non-people to their rulers, valued only for providing the labor needed to satisfy the gluttonous appetites of the elite, or to serve in the armies of conquest or defense.

And that same game goes on today.

The problem is that that undying urge ever resists tyranny. If it cannot overthrow the power which forged its chains, one of two things 'happen'. Either ever-more-stringent master/slave relations result in apathy and retreat from the harsh reality, or those serfs with a strong "reflex of freedom" flee, to escape the tyranny. They move out from under the oppression, and create new centers of growth, and the pattern repeats.

It was just such induced mitosis which was the impetus for creation of this "new nation, conceived in liberty, and dedicated to the proposition that all men are created equal".

Those who fled that particular tyranny held "a decent respect for the opinions of mankind" long enough to establish a government which protected liberty, and provided a standard for all men, everywhere, to emulate.

From the beginning, that government was under attack by men still possessed of the desire for "pelf and power". From the beginning, these self-appointed elitists knew that they could never reassert the power their

appetites demanded, so long as there was one piece of territory remaining to which the oppressed could escape. Always, their lust for power would be denied, unless they ruled all the world.

How they set about to realize their impossible dream has been the subject of many a pamphleteer, and not a few books. Today, the Plan they devised has advanced so far that it can no longer be denied that there IS such a group, with such a goal, and deeply involved in the machinery of all the governments of the world. There is general knowledge in the United States, in particular, of several of the most prominent present organizations, promoting their "New International Economic Order".

It has become so evident that such is the case, that the Establishment itself is bringing out books, articles and other information, not just admitting their existence, but implying that they have already won their battle, and they are in control.

This is a strategic move worthy of a Tsun Tzu, but it has come either too late or too soon. Too soon, because at the time Richard Rovere admitted the existence of that 'benevolent' society known as The Council on Foreign Relations, the American people weren't ready to hand over their inheritance to these kindly, intelligent, knowledgeable, dedicated, capable 'internationalists'. Too late, because, by the time it became generally known, too many Americans had become roused over the usurpations of their heritage to permit them to lie down and play dead.

Too soon, because too many Americans still know in their hearts that there is no place on earth offering a better life than that provided by the United States Constitution. Too late, because, too many Americans once more believe that it would be better to be dead than led - into slavery.

Many of those Americans still need to know who is doing this to them, and why and how, if they are not to be tricked once more into trusting false promises, false hopes, false moves, and false faces.

It is our purpose in this book to expose some of the myths about this scheme, because, then, a strategy is revealed which began about a hundred years ago, and which is still being used today. That strategy includes deliberate crises created to achieve the goal, resulting in two "world wars", two "police actions", brush wars all over the map, and uncounted dozens of confrontations between citizens and officials.

Only a general understanding of the full portent of current events, with the righteous indignation that understanding would cause, can bring a halt to this assault on civilization.

#### SUGGESTED READING:

The Declaration of Independence  
A. Lincoln, "The Gettysburg Address"

They all had more money than they could ever use themselves, those men who dreamed the impossible dream at the turn of this century. They had power, each in his own circle of influence, but it seemed it was not enough. When you have all the money you need - and more than you could even count in a lifetime - there is not much satisfaction in trying for still more. Especially since money creates money. When what you own is incalculable, its self-enrichment makes adding to it through personal effort an exercise in futility.

But POWER - that is something else. It is like a drug. It gives a sense of exalted personal worth far beyond merit. Once tasted, the urge for more power is irresistible to some people. Each additional taste of power creates a drive for more, until life without it seems useless.

The Dream was not original with these men, nor was theirs the same dream shared by the general populace.

Keeping in mind that The Dream has apparently been around as long as man himself, the actual mechanics of the present effort to turn it into a reality can be arbitrarily determined to have begun in the first decade of the twentieth century.

Admittedly, it is impossible to compile all the pieces of such a mammoth undertaking as this in a single tome, so it is submitted as a beginning, that what is reported in this book is "taken out of context". Selection of the salient information has been based on the premise of the public "need to know" that intelligence which is vital to any attempt to regain the firm foundation provided in the lawful government of these United States.

The basic strategy underlying all revolutionary moves is deceit. It is not necessary to point out each and every instance where this strategy is used. It is pandemic, and that fact should become part of the intelligence considered in any confrontation, on any front. With that as the point of beginning, two vital areas of strategy will be traced. The first is "re-education" of the public. The second, reorganization of the government.

Since time began, men have dreamed of Utopia, and, throughout history, attempts have been made to form "ideal" societies. All such efforts have failed, because of the inherent nature of man. Part of the cause of failure is that men are not angels, and it would take angels to realize Utopia. A large part of the cause of failure, though, is that some men are closer to satan than to angels, and these are willing to use that age-old dream of heaven-on-earth to their personal advantage.

It would seem that the powerful men who spearheaded the present movement toward "universal peace" made a conscious decision to turn the dream of the common man for a world of cooperation, into a nightmare of a forced collective, managed and controlled by agents of their own choosing.

With Utopia as a stated Goal, these modern machiavellians use the inborn desires which are present to a greater or lesser degree in Everyman, to extend their power and influence over all the world and all its peoples.

The men who framed the Constitution of the United States had tried, in a productive way, to prepare a climate where that Dream could be realized by everyone with the initiative and desire, without negating the rights of others. Those wise men knew that, in the final analysis, it would depend

on the generations to come whether or not they would realize that Dream.

It has been a source of wonder that, with the exception of Liberia, no major effort has ever been made to extend the influence of the American Dream. That path held real promise of making the Dream a reality for all mankind.

RECOMMENDED READING:

"The Republic" - Plato

"Erewhon" - Samuel Butler

"Looking Backward" - Edward Bellamy

Reactionaries who would take the world back to feudalism suborned the sources from which their intended victims could expect to obtain information - the schools, the press, magazines, libraries, tv, radio ... but that was not enough. They knew it was also essential that all knowledge be adapted to deny their victims the foundation on which they could stand as a free people.

That foundation would include knowing the nature of their heritage, and, especially, the nature of the threat to it. It would also include some conception of the source of that threat. This being so, branches of the movement to subvert all governments under which there was any taint of 'liberty' began systematically to remove source material from the libraries, revise history, rewrite textbooks, diminish the training of teachers, so they knew how to teach, but not what to teach.

Before all this could happen, however, the memory of what went before had to be watered down.

Consider: In America, while the generation still lived which fired the shot heard round the world, there was a jealous guardianship of their hardwon freedom from tyranny. The second generation of Americans learned from their sires, firsthand, the heroic tales of the struggle, and grew to be citizens worthy of their fathers.

By the time the third generation of citizens of the United States of America took their place in history, most of the giants of the Revolution had become part of history, and the stories of their valiant fight were no longer colored with personal remembrances. Liberty had become the norm in America, and the oppression which lit the flame of revolt was dimmed by distance.

But there was another factor contributing to the lessening of an alert guardianship over the heritage so unique in all time.

The "nobility" never accepted the revolt of their underlings. Not just in the United States, but even more strongly in their own territories. The revolution in France, which began in much the same manner as that in America, with at least equal cause, was turned from its course, just as was done in Russia a century later. In both these incidents, the movement became a carnage, and the revolt of the people there was used to reinstate rule by an elite.

The germs of corruption, which decimated both the French patriots and their former oppressors, grew by what they fed on. The new elite created carriers of the disease, and sent them out all over Europe, to England, and even across the ocean, systematically to attack the ideas underlying the moral rejuvenation of the natural rights of man.

Robert Owen began his crusade for "cooperation" in England, and carried his red banner to America.

Out of the sick mind of Isidore Auguste Marie Francis Xavier Comte came the birth of "social science", and the Positive Philosophy, both of which undergird "scientific socialism".

The so-called communist movement began in Europe. After sowing the seeds of the 1848 revolt, Karl Marx was sent to England, there to prepare the handbook designed to ensnare the most unlikely candidates - the workingmen of the world - into support of the attack against them.

In England, the Fabian Society was created to obtain entry into the

world of academe, adding pressure from above to pressure from below, as well as centralized direction for the strategies of the movement.

These are but a few of the thrusts directed against the spirit of independence, just beginning to shed its light on a dark world. There were others, and from each of them, sycophants spread out, infiltrating colleges and universities with their radicalism, entering political arenas to color the laws red, penetrating social and religious groups, infecting all with whom they came in contact with their sick creed.

By the time the twentieth century began, the stage was set for the beginning of what may be the last act, as the "economic royalists" began to take their places on stage - or, rather, behind the scenes. On stage were their puppets. Just a few, at first, then growing in number.

As this act began, the war was on in earnest, as one step after another took them toward their goal, almost without constraints.

By midcentury, though, they began to meet substantive resistance, which continues to grow, and is beginning to have an effect. Is it enough? Only time will tell.

ADDENDUM:

'incident' = "something dependent on or subordinate to something else of greater or principal importance" - Webster's New Collegiate Dictionary/1980



Unless one lived through the strange years which history is recording as the time of 'the anti-Communist hysteria', the situation today is certainly puzzling. It is analagous to being dropped off on some uncharted planet out in space - a planet occupied by people with another language, other cultures, other habits, and other goals. Those problems would be multiplied, if such a visitor had been given a false briefing on the conditions to be found on this mythical planet.

There'd be no way to tell which were "the good guys", which the "bad"; no yardstick with which to measure truth; no guide for personal conduct. If the inhabitants of that other world also were bent on preventing understanding of their ways, the visitor from earth would be hard put to cope with it all. Especially would this be true, if there were some marked discrepancies in whatever information was made available by the denizens of that other world. Not knowing what was truth, and what propaganda, the visitor could not be faulted for being beset with doubts, and chaos and confusion could be the expected result.

The only recourse for such a stranger in an alien land would be to defer to his own reaction to the messages being sent, and to sort out for himself those which were consonant with his beliefs, principles, and past experience, and those which were dissonant, and use these to guide him.

This is the situation in which earthlings find themselves today. They are strangers in their own lands. Fortunately, there is an echo of the situation which existed during the beginnings of this country. There are those among us - just as there were then - who carry memories of the past, some were even part of it, and can keep what was in focus.

Some of these have kept copious records of events which led to today's situation. These records are not dependent on appearance, hearsay, or linguistic problems. They provide an accurate and sequential history of the interventions which have advanced this revolution. These records and memories irrefutably provide a yardstick both for truth, and for measuring the validity of personal values.

Many of these who remember are striving mightily to dispel the effects of current constraints on truth and understanding, and to chart paths through this wonderland of confusion. Even for these, though, it takes some doing to brush the debris of the tangled web of camouflage from paths which still exist, and to bypass those destroyed. Hardest of all is the choice as to which path promises to be most likely to lead out of the morass which impedes both vision and progress.

During those years, when the preponderant voice of the people was heard through the various departments of government, many official investigations of the proliferating problems were conducted. At that time reliable official reports were issued on subversive activity - identifying people, movements, strategies, tactics, and ideologies involved.

Gradually, as the 'government' assumed a shared interest with the subversives, the voice of the people, speaking through representatives, has been muted.

As conflicting messages began to issue from the labyrinthine chambers of officialdom, citizens began to fill the void left, as the voices of their representatives were stilled and the news media failed to report the issues involved in the conflict. Networks of information outlets were

created - some reliable, some not - which covered the country. With the mixed messages from 'government', the media, and volunteers, it is not to be wondered at that the great multitude not directly involved have been unable to differentiate among them. No wonder they drift into 'apathy', c  
move in nonproductive circles!

The mass media offers little hope for remedy - to the contrary, it is responsible for much of the problem. The handful of sources of reliable information cannot wholly make up for that, as they do not have mass distribution, nor financial resources to achieve it.

Of some considerable importance is the fact that the truth sometimes hurts, and when the truth involves those who are in positions of power, either the truth suffers, or the messenger carrying it does.

The truth must be carefully and conscientiously sought, if one is to avoid being trapped in the meshes of the subversive network. Many of the 'remedies' which gain widespread support today are, in fact, of benefit to the revolutionary cause. With general knowledge of the interlocking connections behind these 'remedies', they could be prevented from divertin  
productive effort.

The world today needs the capabilities and the courage of a Patrick Henry, to seek "the truth, and the WHOLE truth; to know the worst, and prepare for it."

#### ADDENDA:

'anti-communist hysteria': the widespread resistance to the "New American Revolution" (as Nixon termed it) beginning in the early 1950s.

'government': this is a key semantic fiction. As a tool for subversion, it is applied to the revolutionary agents (or their "handmaidens") acting within government departments; factually, the "government" is the lawful form of organization provided in the Constitution and laws made pursuant to it.

'apathy': this is a condition being deliberately fostered through use of systematic subversion of the public mind, applied by various tactics - created chaos, appearance of overwhelming odds, contrived ability to retaliate against citizen action, and other elements of "brainwashing" - all designed to neutralize the will to resist.

'remedies': Hegelian dialectic: create problem in present condition, posit alternative, achieving predetermined goal.

It was the market crash of 1929, which prepared the way for the syndrome of centralized planning in the United States.

Over a hundred years of ivory tower theory, with more than a quarter century of that time spent in practical field testing, were brought to a critical point on that fateful day in October.

Was it planned that way? There were some who thought so, even then, and their number has increased in the eventful years since. For it was then that the chorus began. "With government controls," the Planners chanted, "such a crash wouldn't have been possible."

A great many Americans felt the impact of that crash, and some listened to the siren song of Planning-by-Government.

The years of depression which followed the crash touched every family in the nation, one way or another. Was that planned, too? Some thought so then, and more think so today. The long years of continuing deprivation, and government efforts to "correct" the problems softened the strong spirit of independence which had characterized the American citizenry. Loss of that spirit made acceptance of the fallacy of central planning possible.

Opposition to the controls which must accompany planning-by-government, is always characterized as opposition to planning. NOT SO! What is at issue is not "planning", per se, and never has been. Everyone plans, every day of their lives. It is WHO is to do the planning, and for what purpose, that is of concern.

Just as, in those early days, some citizens recognized that the 'New Deal' was not a square deal, so, today, there are those who recognize that centralized controls do not prohibit debacles such as the crash of '29. Some even recognize that, with 'government' controls, such situations can be created to further hidden ends.

Occasionally, there is proof that a created crisis exists. Usually, that proof has to be collected laboriously, through long, arduous hours of research. Seldom is there a readily available public record which openly states that a particular event was staged for a specific purpose, or that some project has deeper meaning than its surface appearance would indicate. Rarely is there overt evidence of a deliberate, calculated scheme by government officials, to deny citizens their rights under the Constitution.

In the case of the gas 'crisis' of the 1970s, there is such evidence.

In the summer of 1978, James Schlesinger, federal energy "czar", ordered a Guide prepared by his department, to be "available for use, if needed this winter". Purportedly to develop means of alleviating energy-related disruptions ranging from "power blackouts to another coal strike", the Draft of the Guide spelled out the real intent for the Energy Department

"to stage FAKE emergencies around the country in the next three years as a drill to gauge...preparedness."

Openly stated intent of the created crises includes a four-day work-week; government determination of the hours businesses could operate; and diversion of the vast amounts of electricity used in producing nuclear reactor fuels, to civilian use.

The Draft report states:

"...throughout the exercises, no participant will have advance knowledge of the scenarios, or of the mock emergencies to be used."

One has to wonder about Three-Mile Island, in the light of this information. One wonders as well at the fuel "emergency" which prompted frantic scurrying around by motorists, to find a station open, pumping gas, and long lines of cars with frustrated owners resenting the wasted hours.

The first of the announced objectives was put into effect almost immediately. With the accelerating promotion of 1313s "Business Improvement Areas" (BIAs), since the mid70s, government control of the hours businesses may operate has become a standard pressure area. Other recommendations in the Guide were held in abeyance waiting further developments.

The Draft of the Guide which was made available to the Press, was reported in the New York Times on 24 November, 1978 right after its release, but both the article and its headline seemed so innocuous that the admission of creation of crisis in the body of the report all but escaped notice. Absent any evidence or suspicion that officialdom would deliberately experiment with the lives and security of its citizens in this fashion, the statement of intent which was included was easily overlooked.

At the time I first reported on this incident, in June, 1979, there had been a number of puzzling aspects to the oil situation. Strange things were going on in oil production, both here, in the United States, as regards 'government' intervention in new well starts, off-shore drilling, and the Alaskan pipeline; and in the Middle East. It was two years later, before all these began to take form.

In 1981, a courageous man, who'd been chaplain to workers on the Alaskan Pipeline Service, wrote a book about what he knew about the 'crisis'. Lindsey Williams' book should have caused a stir greater than Watergate. It didn't. The question must be asked: WHY NOT?

The use in the Guide of the terms "scenario" and "exercises" is deeply concerning, for the former is an element of the management and control system (PPBS), with no other identified function in government, while "exercises" describes the activation of a PPB "scenario". "Exercises" is a term also applied to military maneuvers, both in training "war games" and as battle is enjoined.

Is it fair to assess such actions by a government Department as an attack - not just on the sovereign citizens, but on the foundations of the government itself, as a consequence?

Is it safe to assume otherwise?

RECOMMENDED READING:

"Ordeal by Planning", - John Jewkes, Professor of Political Economy, MacMillan, 1948

"The Energy Non-Crisis" - Lindsey Williams, Worth Publ. 1980

\* ACIR Publications: A 31 - "Fiscal Balance" (1967), and M 39 - "State Legislative Programs" (1969)

"There is an undercurrent of political thought in the United States today, which drifts toward socialism, and this unconscious drift leads up to a grant of power to our Executive Department quite necessary under a socialist government, but which creates a danger to our institutions. Successive grants of power to an executive have always ended in Empire with Republics of the past, and usually the additional power has been given at the instance of the "common people"..."

- Col. Ed. F. Browne

For many years, the identity of the author of "Socialism or Empire " has been sought, in vain. It may well be that the author used a pseudonym, for the name of Col. Ed. F. Browne seems to have been blotted from history, except as it appears on this rare volume.

This writer has long since discounted the need to prove a source, if the information provided can be validated. It is so, with this book.

With the above quotation, "Col. Browne" begins the introduction to a most remarkable account of a very serious matter. If the above quote sounds as though it could be from one of the current crop of polemics about the problems facing America today, be advised that at least half of this book gives the same eerie feeling - eerie, because it was actually published in 1906!

Col. Browne's thesis has to do with the beginnings of the movement to destroy the liberty of the American people to move freely, by means of government control of transportation.

Present efforts to obtain citizen support for grants of "free" money from the federals for construction of roads and scenic highways, make it imperative that facts be made known before the inevitable extension of power to the federal Executive is fully achieved.

As Col. Browne begins to unfold his narrative exposure of the wheels within wheels which were beginning to turn America Empireward in 1906, it is difficult to fathom how the trickery was seen, and recognized, so long ago - and that its effect on the lives and thinking of Americans could be so accurately described, before there was any real impact. Given that circumstance, it is also difficult to understand why the federal takeover of the railroads was allowed to continue. Even though then-current events are now history, and dictionary and encyclopedic definitions have been altered, the points Col. Browne made are still valid - and significant - today.

Even the title of his book has significance. "Socialism or Empire " is one of the early books which pinpointed the real dangers to American liberty, through altered concept. This is demonstrable by comparing the meaning of the word "empire", then, and now. As defined in dictionaries of that time, "empire" meant "supreme power in governing; dominion; sovereignty". "Dominion" was defined as "the right of uncontrolled possession; use and disposal of supreme authority; the power of governing and controlling". "Sovereign" was defined as "supreme in power; not subject to any other".

In today's dictionaries, "empire" is defined as "a major political unit, having a territory of great extent". "Dominion" has become "a self-governing nation of the British Commonwealth"! And "sovereign" alone

still retains its original concept. This last is seldom used today, except in reference to the "sovereign citizen", and there is a reason for that. It is intended that Americans should continue to believe themselves the ultimate power in this country, as recognized by the Constitution, no matter how much of their inherent power they have given away, delegated, or had usurped. No matter that common-sense - and history - shows that you can never have your cake and eat it, too, we are to continue to believe that our destiny is still in our hands until some unhappy day when we are forced to recognize that the threads of control have become bands of steel - raw power, immutable to resistance.

But "Col. Browne" saw, back in 1906, that there was even then an assault being made on the American people and system - an assault so total that (as we suspect) those who tried to warn of it, had to resort to 'fictional' accounts of its existence, or use false identity to plead their case, as we believe was done by "Colonel Browne".

While the central theme of his book is the issue of 'government' takeover of mass methods of transportation, his description of his fellow citizens as being "...so absorbed in business pursuits, or busy with their own affairs, that they pay little attention to public matters", is a harmonic theme which is still true today.

Browne's delving into the socio-political situation; his references to our form of government; his choice of examples to illustrate his points; his careful reporting of events; and his exposure of the power-seekers who were then responsible for the assaults he describes - all have meaning for today.

Most significant, perhaps, is that he looks ahead, down the corridor of time, and warns against the inevitable result of such tinkering with the basic principles of self-government, and/or toying with the mental processes of American citizens.

That this book never received the attention it merited is a tragedy. If the lessons Col. Browne tried to impart are not taken seriously today, there is no question that it will not take another eighty years to make them academic.

#### Recommended Reading:

"Socialism or Empire - a Danger" Col. Ed. F. Browne - "The most serious question presented to the American people since the abolishment of slavery is not receiving due consideration" - Kloppe and Bartlett Company, Omaha. 1906

Time was, when "conspiracy" was a word only a "right-wing extremist" would use to suggest the cause of a world convulsed in turmoil. Few saw that turmoil as a result of a planned assault on existing institutions.

No more. In the late 1970s versions of 'conspiracy' began to be heard on all sides - pouring from the mass media as well as from ordinary folk, as the "gas crunch" squeezed everyone. Only the oil moguls - and the Resident of the White House and his minions and bosses - proclaimed this 'crisis' to be the result of events which "just happened".

Most opinion seemed to center around the idea that the "shortage" was arranged by the oil companies, just to get higher prices. This is unrealistic. The same people, who stood to gain monetarily through this ploy, have been playing for higher stakes for years. While attention was directed to what the gas crunch was doing for Mr. Big, almost none was given to what it was doing to Mr. Small.

For many years, there has been an apparent attempt to herd the citizens of this country into urban centers. The stated reason has been that it is easier and "more efficient" to provide services, such as utilities, for a compact area. (This ignores the historic role of government in that this is a basic function for which governments exist.)

Those with a "conspiratorial view of history" contended that it would also be easier and more proficient to control the population. Naturally, such people also believed that there was an intent to do just that. That there was reason for that belief was never given credence by those refuse to accept that a Plan with an identified Goal exists.

Despite the skeptics, there is strong evidence to support such a belief.

Early evidence was mainly limited to statements of 'radicals', who, of course, could never carry out such a scheme. Later, the efforts of the Planners to surround the cities with "greenbelts" - parklike areas, where no buildings would mar the scenic beauty - exposed further intent. Ecology freaks supported the Planners, but it was still too difficult then to ignore the demands of the owners of the property designated to remain virgin, so greenbelts were soft-pedalled for a time. Emphasis was placed, instead, on gaining acceptance of the planning idea, by gradually increasing controls across the board. A little here, more there, and, like the threads of Lilliput, the controls eventually became ties that bind.

A landmark case in the Los Angeles area involved the Walter O'Malley stadium. In my mind's eye I can still see the TV report of the removal of the last resistor to try to hold her property there - a fragile, very old, Mexican-American woman whose family had owned that piece of land since the Hidalgo Contract - being carried bodily from her home by a huge burly 'enforcer', her thin arms and legs flailing in protest, while the bulldozers panted in the background. The giveaway of that land for a ballpark set a precedent, and was later used by collaborating state legislators to pass bills to take over private rights in property by "law".

The Leslie Salt people made a stand to retain use of their salt flats in the San Francisco area, but were overridden by creation of "ABAG" - the regional Association of Bay Area Governments. Tahoe was taken over by legislative action, and the people there not only lost property rights, but

representation as well.

Piece by piece, the Planners worked the old baloney trick. They took slice after slice of property rights, until there is now little left worth struggling to preserve. Some property owners still continue to fight, however, as the strategies being used to achieve this objective become more insistent. As witness:

With the eager cooperation of 'conservative' Governor Ronald Reagan, the Planners made their big bid to establish the the land use planning (LUP) scheme as government policy using California as a test area. A prestigious Task Force was created, and given the monumental assignment of restructuring local government to meet the 'need' for the new role of urban areas. The Governor called it his "dream - but not the impossible dream" But it was.

After holding hearings all around the State to increasingly hostile groups of citizens and local officials, the shambles of the Governor's "dream" had to be dropped back in his lap, with the Task Force pronouncement that it was not only not wanted - it was not needed.

But the Planners never give up. Newly elected Governor Jerry Brown lost no time in offering Reagan's "dream" as his own - but he was more honest, and called it a "strategy". He boldly backed this fresh attack on property rights with all the power of the Governor's office.

Brown's "Strategy" came right out and drew a physical boundary around existing urban areas, demanded 'infilling' (building on existing parcels bare land) in the cities, before granting permits for use of land outside the perimeters; established policy for state takeover of private property which did not meet Strategy standards; provided for State determination of allowable population growth; and a whole series of similar usurpations. The Strategy called for 46 new laws, two amendments to the State Constitution, and an Executive Order by the Governor to make it legal.

But Brown ran into the same buzzsaw which woke Reagan from his "dream" and his scheme was quickly taken underground. Some bills were quietly passed in short order, others waited an opportune time, quietly proceeding to make the Strategy 'legal', despite widespread opposition.

So then came the "gas crunch". Would it succeed, where more direct measures failed? With a fuel shortage, who would want to live any distance from the city, where the jobs and retail outlets were, if there were a possibility that transportation would fall short of the need? No doubt about it, one way or another, the Planners expect to obtain this kind of control, and they never give up.

No, they never give up. In late 1987, Willie Brown, Speaker of the California Assembly (no relation to Jerry) issued a Call for the same "dream", announcing that he had a whole package of legislation for it, and demanding that the incumbent Governor create a "Task Force" to lead the way! As this is being written the pressure is still on to achieve this objective.

When the public can no longer drive their cars, or enjoy the remnants of 'public transportation' - two elements which made possible "the good life" Americans have known - will they quietly sit back, and let the noose be slipped over their heads?

When the long grey highways are empty and the bright cars which once flashed over them sit idly in yard, garage, or junkheap, will Reagan's dream, and Brown's Strategy and Willie's power have the final say?



ADDENDA:

'crisis' = a created condition, conducive to 'change';

'radical' = anyone who is not a supporter of the revolution;

'liberal' = anyone who IS a sycophant;

'conservative' = anyone who actively resists the revolution;  
someone against 'change';

'change' = The New International Economic Order, and/or any  
of its elements.

'public transportation' = mass transportation - once under  
private ownership and privately operated, gradually forced into  
government control and/or ownership.

RECOMMENDED READING

"A Cityless, Countryless World - Practical Co-operation" -  
Henry Olerich, Self Publ. 1893

"Urban Development Strategy", California State Office of  
Planning and Research, 1977 as revised

While our 'government's interest in how people get from place to place really had its beginnings back in 1887, as Colonel Browne's book demonstrated, solid evidence of that interest as a threat to individual citizens came after world war 2.

There had been warnings, such as 'government' interference with the railroad companies, but that came at the time of the Great Trustbuster ("Teddy" Roosevelt), and it was made to appear to be "in the public interest". Continuing assaults gradually created the impression that "the railroad interests" were at odds with "the public good". The error in such thought becomes clearer, as the "public good" suffers increasingly from 'government' bungling in matters where it has no right to intervene.

A silent witness - the shining steel tracks, which opened this country to progress - now lie covered with dust, rust, and weeds, and the 'government' operated AMTRAK flounders, even as 'government' prepares to take over or control all transportation.

The danger signals have been raised for years, and logic shows why. A case in point involves a "bedroom town" in the Los Angeles area.

On a map, the outline of the town resembles an hourglass. The pinched center was sparsely populated, and the one bus company in the area refused to service that section, on the premise that it was "economically unfeasible". Instead, its route went from the top "bulge", through an adjoining city, and back to the lower "bulge", leaving the residents in the middle without transportation, other than shank's mare, for most of them didn't own cars - or the one they did own was used to take the "breadwinner" to work.

A couple of young world war 2 veterans, who lived in that area, had a different idea. They pooled their resources, obtained a temporary permit, bought a little old bus, repaired it, painted it green, and started rolling. Forbidden by law to compete with the other line, they traversed only the "unfeasible" route. Yet, they provided such outstanding, dependable, courteous service, that, before long, people who formerly had used the other bus, now walked out of their way to take the "little green bus", and the people who lived along their route were more than happy to find the venture doing so well.

When it came time for a renewal of the license for the little green bus, however, the other line threw all their weight into opposing even that, let alone a permanent grant of use.

I lived there, at the time, and the little green bus was a Godsend. We were on a hill, and there were no stores at all up there. With two little boys (one in a carriage, at first, and then in a TaylorTot) to bundle up and take with me, just shopping for groceries was a major project. Going down was not so bad, but coming back up the hill, with the added weight of the purchases, was something else.

So the little green bus made a real difference. Then, one day, the driver told me that its days were numbered. When I asked him what he meant, he said that it looked like the permit might not be renewed. He told me that the only hope was for the people who used the bus to appear at the City Council meeting, and try to convince the Council that it was needed.

That was my first attendance at a government meeting, and it changed my life! I couldn't believe what went on! It was Alice in Wonderland, and made

nonsense.

Though the routes were not conflicting, the difference in service was notable, as the people testified, and the other line had suffered a measurable loss of patronage. 'Government' sided with the original company, and the little green bus was no more.

While this was going on, other signposts were visible in other areas. In Southern California, for instance, the historic "electric cars", which, for half a century had effectively transported citizens from Long Beach to San Fernando Valley, and from the South Bay to Pasadena, Azusa and Cucamonga, were being phased out through 'government' pressure.

The time came when citizens were forced to buy automobiles, whether or not they could afford them, just to get back and forth to work - or anyplace else, for that matter. There were not enough busses, and the routes 'government' set for them did not cover the need. Two car families became a commonplace.

The streets were choked, morning and night, with commuters, and Los Angeles and environs also choked - on exhaust fumes.

So 'government' stepped in to relieve the 'problem'. Immediately, backyard incinerators were outlawed - although no case was ever proved against them. (And that started another 'problem' - but that's a different story.)

Freeways mushroomed everywhere overnight, it seemed. As the population increased, more freeways were constructed, and more controls were placed on people. The 'solutions' were obsolete before the ink was dry on the regulations.

"Planning" became the warcry of 'government', but it seemed that the more 'government' planned, the less effective were the 'solutions'.

To solve this problem, the harrassed users of "the longest parking lot in the world" were offered the boon of an "express lane", as a precious jewel - to reward those who could find two riders living near them, with a proximate destination, and who didn't mind sharing their car with strangers. Today, 'diamond' lanes have sprung up around every major city in the country. What a blessing carpools can be! To have the joy of speeding past all those clods, who couldn't (or wouldn't) "share the ride"!

As they inhale the fumes of exhaust from all the other "loners" (as well as from the cars in the 'diamond' lanes), those clods can listen on the radio to the seductive tones of 'government' calling them to "Come ride on the RTD with us..."

It would seem that someday, somehow, somewhere, someone in authority would really look at the substance of this problem, and decide that those giants of men who built the government under which this nation prospered and grew for so long, HAD something, when they denied the use of regulatory agencies such as had brought revolution to these shores so long ago. Perhaps, then, someone with authority to do something, might notice that the revolution which resulted in formation of these United States is being betrayed by the "New American Revolution" going on NOW.

It can also be hoped that, someday, somehow, the people can be brought to recognize that those to whom they have given their trust are causing this travail - either by what they are doing, or by failing to do what they should.

People ask, "Why spend so much time dwelling on the past? We all know what happened; better to do something about it, than to always be digging up all this old stuff that no one needs to know."

As we said up front - everybody does NOT know what went before. ] Anything constructive is to be done about the problems of today, this stuff" is vital. If this revolution is to be reversed, the counter revolutionaries - those Americans who care enough to "do something" at it - must have knowledge of the strategies and tactics being used to achieve the revolutionary goal. This is the eighth principle of warfare. In the military, it is called "intelligence".

Take the matter of "humanitarian aid" to the so-called contras. Whether there be a difference in the public opinion polls, if the American people were told in the "news" broadcasts (which is the source from which most people get their information/intelligence), that this has been a successful revolutionary strategy since the loss of China to the free world?

How many of you reading this know that it was Dean Acheson who devised this scheme - or at least put it in motion? Acheson and his Assistant Secretary for Far East Policy, Owen Lattimore, were part of the "China Lobby", which used this same policy to permit China to go under communist control. Lattimore was later identified by the Senate Committee on Internal Affairs as "a conscious, articulate agent of the Communist Party")

It was Secretary of State Acheson who went before a committee of Congress, MONTHS before the communist hordes swarmed down into Korea, made an impassioned plea for "economic aid" to "contain communism" in the ill-starred nation. He did not seek - or want - military aid, even in the face of the known threat of invasion there. He specified ONLY "economic aid (as it was called then) which some in Congress charged would only whet the appetite of the Reds in the north.

Syngman Rhee, Korea's then-President, and a staunch ally of the United States, was begging for military help, and Congress saw the merit in his position. They repudiated the State Department scheme, and appropriated millions for Korean defense, only to learn much later, after the invasion, that a mere \$200 had been spent for military aid - and that even the weapons purchased with that never arrived in Korea!

The story was the same in China, the Shah's Iran, Vietnam, Cambodia, Nicaragua and El Salvador. Billions of American dollars sent tons of "humanitarian" aid to each of those countries, just in time to have the materiel appropriated to the benefit of the communist successors.

The devastating debacle of the rout in Vietnam was a repeat of the tragedy of the Korean nightmare. The hostage situation in Iran is directly traceable to the same indefensible ploy.

The record shows that the consistent position of the strategic activists in control of United States foreign policy has been firmly rooted in clouds of wishful thinking directly related to their impossible dream of a new world order, rather than on historic truths, scientific probabilities, or military necessity.

When a nation is under attack, and in mortal danger, there is no weapon other than that which can be used for defense or assault can help the endangered people.

The dead hand of Acheson now reaches out to fatten the goose of Cer

America for the communists - just as it did live in China and Korea and Vietnam. Could this 'happen' again, if Congress and the people knew that this strategy was at the heart of the loss of China and those two "police actions"? If the American people knew, would they rise in righteous anger, and forbid their representatives to send blood money to these present day Ghengis Khans? Would they demand action more likely to be in the real interest of the United States and its allies?

Knowledge such as this is basic to truly corrective action. At least one United States Senator recognized this, as he took the Floor of the Upper House on the 19th of May, 1954 on a Special Order, to discuss what he described as:

"...a devastating situation, which disturbs me deeply. The outcome ... may well decree the death, or ensure the life, of our free civilization..."

Assisted by a young attorney loaned to him for this purpose by the Senate Permanent Investigating Subcommittee, the Senator proceeded to present background for a discussion of what was then called "the cold war".

The Special Order had been triggered by a public announcement from the Office of the Vice President that American young men might have to be sent to fight in Indochina. The Senator spoke of the incredible policies being utilized in Far East relations, and outlined known Soviet aims in that part of the world. The battle for Indochina, he warned, would ultimately determine control of the entire Pacific, and he cited Soviet policy and goals to confirm the cause for his concern.

The Senator went on to describe the incredible policy which permitted the United States to ship crucial materiel to communist-bloc nations, despite the knowledge that THEY, in turn, were supplying the war machine of Red China, which, also in turn, was supplying the war capability of both North Korea and North Vietnam.

He spoke of the equally incredible policy of permitting aid from these communist satellites to arrive in Red Chinese ports, on ships carrying the flags of our allies, who were actually receiving aid from the U. S. at that time. He revealed the unbelievable policy of our State Department, which required that the wars in Korea and Vietnam be fought only on the territory of the nations we supposedly were befriending, and never taken beyond their borders into enemy territory - thus laying waste the country we were "helping", and protecting the enemy's war-making capability!

The Senator wound up his lengthy colloquy with this:

"The point I wish to make is this: that we must not even remotely think of sending American boys to the jungles of Indochina, while we are financing the shipment of guns which will kill those young men after they get there."

If that speech by that Senator had made headlines in the next morning's newspapers, fifty three thousand young Americans might not have lost their lives in the jungles of Vietnam; uncounted thousands of other Americans might not have had to face a bleak future maimed in mind or body (or both), or forever burdened with grief for the loss of loved ones; and many young Americans would not have had to flee their native land to avoid that tragedy for themselves.

The Vice President, in 1954, was Richard Milhaus Nixon. The young

attorney was Robert Fitzgerald Kennedy. The concerned Senator was Joseph Raymond McCarthy.

Two of these men were in positions of power ten years later, when they could have reissued this warning as American boys were deployed for Vietnam, and they did not. The third died trying, long before a whole generation of Americans were sent to fight and die under those conditions, which still existed ten years after being exposed, and still exist today.

No need to know? How can such policies be changed, if no one knows about them?

It was just such policies which caused even an old soldier like General Douglas MacArthur to testify to Congress:

"I have seen, I guess, as much blood and disaster as any living man, but this just curdled my stomach... After I looked at those thousands of women and children and everything, I vomited. - are you (Congress) going to let that go on? Once more, I repeat, what is the policy in Korea?"

MacArthur didn't live to see Vietnam, much less Nicaragua. Nor is there a record of his ever learning of an article written by Owen Lattimore, in which that "expert" on Far East policy disclosed that the State Department's big problem was "how to allow China to fall to the Communists, without having it appear that we pushed her." In discussing Korea in that article, this State Department mole wrote,

"The thing to do, therefore, is to let South Korea fall, but not let it look as though we pushed it."

MacArthur and McCarthy are in their graves, and Lattimore and Acheson are long gone from their positions of power, but the evil they did continues to plague the world. This could be due, in part, to the continuing presence in the labyrinthine State Department of many hidden persuaders, holding the same views they held.

A much larger part of the problem lies in the fact that there can be no correction of such situations the existence of which is not known.

No need to know? Gentle reader, the past is prologue!

Recommended Reading:

"Twenty Years of Treason" Senator Joe McCarthy, 19 March 1954, Plankinton Hotel, Milwaukee, Wisconsin, Printed in the Congressional Record, 14 January, 1955, p 299.

Let's face it. Many of the activities taking place today don't 'make sense'. Neither those being carried on in the name of government, nor many which to all appearance seem to have no connection with government. So I may be forgiven if I suggest that there is an overall pattern which provides reason to believe there is a connection, even if none is visible.

Whenever something doesn't "make sense" from a customary point of view, logic would indicate that there is a point, somewhere, from which cause and effect would become demonstrable.

For instance. Some there are who still ruminate over the government program in the thirties in which thousands of piglets were destroyed, mountains of potatoes were poisoned and buried, and oceans of good milk were poured in the streets of America's heartland. All this, at a time when Americans were selling apples and pencils on street corners, trying to get enough cash to feed hungry families. Even the stated reasons for doing these things did not make sense to most Americans. But they certainly made sense to Henry Wallace, then-Secretary of Agriculture who instigated the program.

Things being done today are in the same category.

Does it "make sense"

\*for 'government' to force a citizen to give up some of his lawfully acquired property, in exchange for permission to build on what is left?

\*to deny permission for a citizen to build anything on his property, until units in another jurisdiction on land owned by other citizens, have been built?

\*to continue to send "aid and trade" to the Soviet Union, when we are protecting other countries from the Soviet 'evil empire', by sending "aid and trade" to them?

\*to commingle the essence of such vastly different cultures as the totalitarian USSR and the USA 'free society' with student and educational exchanges?

These are but a few of the ridiculousities in a continuing process of overt 'government' initiation. Consider now, a few which do not evidence 'government' as a source:

- \*The widespread illiteracy among young adults;
- \*The dramatic decline of moral standards nationwide;
- \*The incessant, unending exposure of 'incidents' asserting the perfidy of elected officials;
- \*The astronomical suicide rate among teenagers;
- \*The appearance of the "street people".
- \*The proliferating 'incidents' of child abuse and mass murder.

Does it "make sense":

\*to ignore the easily checked fact that the first two of these sad stats were predicted at the time would result from the "innovations" initiated in education in the government schools more than forty years ago? Or

\*that the third has a twenty year history of a planned assault? Or:

\*that the fourth was not considered as a possibility until about twenty years ago, when 'death education' began to become part of the curriculum in the government schools? Or:

\*that the fifth can be traced to the revisions in treatment of the 'mentally ill'? Or:

\*That no serious attempt has been made to determine a cause for the sixth?

Year after year, and for many years, Americans from border to border and coast to coast have wrestled with these ridiculousities, and a thousand more. Whence come these nonsensical situations? Why so many? How have they continued to plague the citizens, in the face of constant resistance?

If this government is operating under the Constitution, the citizens have the last word. If it doesn't "make sense" that those elected to office won't listen to that word - why DOESN'T it?

Let us, then, create a position from which all the myriad seeming idiocies DO make sense.

Insistently, over the years, there has been an undercurrent of opinion in this country, particularly among the upper echelon of society, which speaks of an intent to create a world authority in which the United States of America would become one of many 'states' in a United Nations of the World - a small voice, lost in the babble of third world demands.

While it may seem a new development to many Americans, the efforts to establish that world authority have been actively pursued since before world war I. Strange as it seems, many of the strategies being described in this book have been SOP (standard operating procedure) all along. The 'peace'-at-any-price movement; the fear tactics of the anti-nuke movement; the international organization to "keep the peace" have loomed large from the beginning.

In the Exhibits Section of this book, there is a photocopy of some content from an issue of the student quarterly magazine of Pasadena (California) High School for November, 1923. Those who have succumbed to the idea that "now that there is an atom bomb, we MUST NOT have another war" will find the lead article in that quarterly interesting, at least.

Entitled "The Prevention of War by Means of a United Nations of the World", the article begins:

"We are told that the next war will last only three days, possible a week. At the end of that time, all the people on this planet will be dead."

It continues with arguments promoting the "United Nations of the World" for three and a half pages of a very slim magazine, building a picture of "the only hope for peace". Some of these arguments are only too familiar today, like this:

"National sovereignty should exist only so far as it does not interfere with the function of the United Government"  
The article ends with:

"...the United Nations of the World will not be a complete



success, until all the nations of the world have joined. In the meantime, education of all the people of the world will do more than any other thing in helping to realize this ideal."

Skeptic that I am, I questioned whether a student actually wrote this propaganda. My skepticism was justified at a later date, when research revealed the source for these unusual quotes (see Documents Section). For the purpose of this discussion, the source really doesn't matter. What is important here is what can be learned from this almost-70-year-old document. That lesson includes exploring the evidence that it is MISeducation which is making it possible for this dream to be realized.

Consider these statements of record:

\*A United Nations - in 1923?

\*An end to national sovereignty - in 1923?

\*A superwar without survivors - in 1923?

Yes.

And ever since then, the cry of peace, peace - when there is no peace. Almost three quarters of a century of promoting internationalism; of implanting concepts in students minds, instead of giving them the tools to create their own concepts; of attacks on citizens who wantonly keep bringing up the Constitution and its 'horse-and-buggy' methods of governing, of deliberate promotion of promiscuity, pornography and prurience.

America Firsters, they were called - all those who openly decried these aberrations. (As though putting America first was a bad thing for Americans to do!) Super Patriots. Hundred percenters. Right wing. Extremist. Isolationist - ultra-right - radical. What is wrong with being patriotic?

What is wrong is that patriots are inclined to expose the soft underbelly of deceit and trickery needed to change the course of history. They are apt to insist on FACTS, truthfully presented. They are prone to argue that it is not the people who cause wars. They are prone to get in the way of "progress" - progress toward that one world 'dream', which they see as a nightmare. They do not hesitate to point out fallacies and deceit, and those who use these to destroy tried and true methods of governing.

It is to allow the most powerful men in the world to continue garnering ever more power, that patriots are purposefully stripped of their respectability. It is for the same reason that human lives are callously sacrificed, whether by wasting away in the Gulag, or blown apart in "wars" manufactured by the power hungry.

Dreams of power have ever ended in pools of blood. Ambition most often leads to a premature grave for the "dreamer", as well as his victims. And yet, the Damoclean sword continues to be ignored, despite the lessons of history.

In most persons, there is an innate something which, even despite years of subordinating personal desires to enforced obedience to tyranny, despite deprivation, suffering, calculated pressures for a man to believe that his country was responsible for his travail, causes him to throw himself face down on the good earth of his native land as he steps off the plane which

bore him back from agonies suffered at the hands of today's barbarians, and to kiss a handful of dirt. This is the basic instinct of which the poet wrote,

"Breathes there a man with soul so dead,  
"that never to himself has said,  
"This is my own, my native land'?"

There ARE such beings (undeserving of the name of "man") consciously negate this basic human urge. They ridicule those whose screams cry out against willful destruction of a cherished heritage. For such, the poet had words today's power-mad deceivers and their minions lickspittle cooperators should heed:

"If such there be...  
"high though his title, proud his name,  
"boundless his wealth as wish can claim...  
"that wretch shall go down to the vile dust  
"from which HE sprung--  
"unwept, unhonored, and unsung."

Unless, of course, the hundred-year war against honor, duty, courage succeeds in its stated purpose of changing the nature of man. In that case, the world will finally have been made safe for tyrants, and to them alone will be the glory.

Then it will all make sense, because Big Brother will see that it does. Any facts which do not support approved official dicta will quietly disappear down the memory hole, and every human being not cloned from Brother will be a genetic duplication of Winston Smith.

Recommended Reading:

"1984" George Orwell - Harcourt/Brace - 1949  
"Breathes there a man" - Sir Walter Scott

# section II

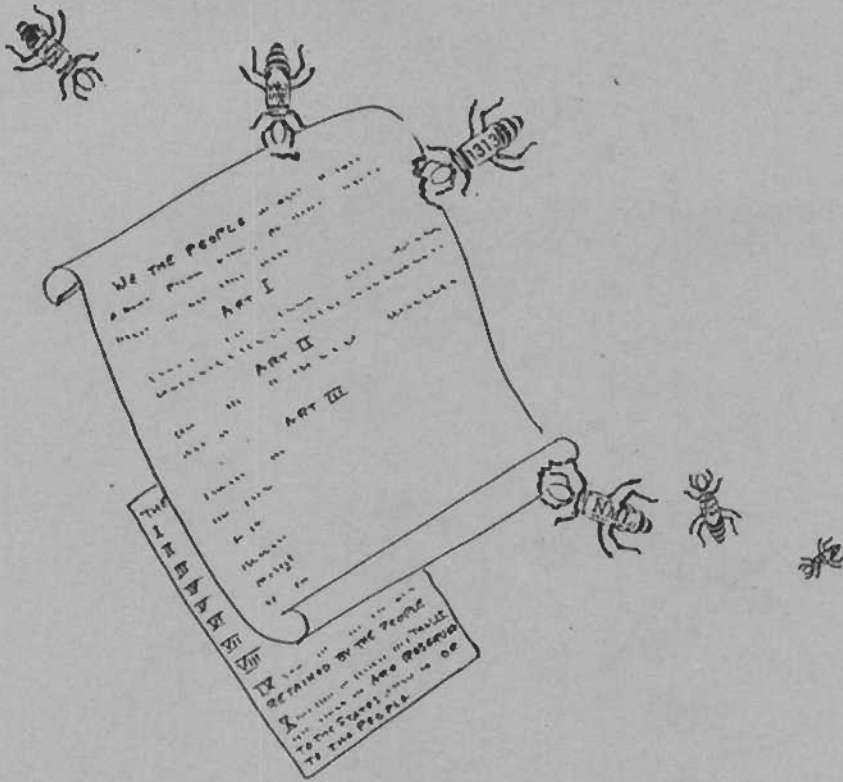

## The Myths of Communism

ch:	pa:
12 The More Things Change...	
Part One	II - 1
The More They Stay the Same	
Part Two	II - 3
13 The Communist Myth	II - 5
14 m-o-n-e-y & Conspiracy	II - 7
15 "Operation Abolition"	II - 10
16 Two Worlds for One	II - 13
17 Joseph Raymond McCarthy	
Part 1 1908 - 1957	II -
2 The Exorcists	II - 18
3 The Legacy	II - 21
4 The Censure	II - 23
5 The Bright Flame	II - 27
18 No More Heroes	II - 29
19 Soviet	II - 32
Technical Superiority	
20 Incident	II - 35
in Tienanmen Square	
21 In the Name of	II - 36
"Democracy"	

Col. Tom Hutton had been a public relations officer, working out of Flying Tigers HQ in Kunming, China, during world war 2. From that vantage point, he observed that something new had been added to the arsenal of war. Until the middle of the 20th century, 9 basic principles of warfare had been utilized by military forces: an objective (goal); the initiative (offensive); movement (flexibility); mass (consolidation of forces); economy of forces (minimum effective need); surprise; security and/or intelligence; cooperation; simplicity.

When Col. Hutton recognized the use by the Soviets of what he later termed "the dominant principle" (dominant, because it can pervade all the others), he dubbed it "SPX" - Soviet Principle Ten) - and he identified it as 'paralysis', in particular, paralysis of the will to resist. His research found it had been activated by the Soviets, and used experimentally on their own people before being integrated into official Soviet military policy.

In his military capacity, Col. Hutton regularly reported to his superiors on the activation and use of this new principle in the pressures to topple the anti-communist government of Chiang Kai-Shek. He documented the participation of the United States State Department in the use of this new strategy against an ally. For this contribution, Hutton was awarded the Legion of Merit, which was presented to him by Generals Chennault and Wedemeyer.

After the war (as a private citizen), Col. Hutton formed an external alliance with other ex-intelligence personnel to study this technique, and to exchange information about it. In time, the group took the name of SPX Research Associates (SPXRA), and began sending intelligence reports to military and other official personnel with a need-to-know.

When the Berlin blockade was set up by the Soviets, Col. Hutton was recalled to duty and ordered to Germany, to serve as Chief of Intelligence in the military government which had been created to guide that benighted country back into civilization and self-government. During that service, he saw further evidence of SPX, which convinced him that SPXRA should be a continuing ex-officio body, and it was registered as such with the Office of External Intelligence Research.

For seventeen years, SPXRA competently, quietly, and unofficially did a job which should have been the responsibility of the War Department, or its successor "Defense" Department. SPXRA did that job thoroughly, well, and at no cost to the taxpayers.

In 1958, the continuing advances of the communist offensive for global conquest seemed to make it imperative that not only officials, but concerned citizens, as well, should have the information SPXRA was developing, and they authorized release of their reports to patriots known to them to be responsible and reliable.

Col. Hutton began to lecture publicly on aspects of SPX which were considered to be in the public interest, and of public concern.

The first big offensive move SPXRA took against SPX was a staff Report on "The Supreme Court as an Instrument of Global Conquest", which was presented at a Hearing of the Senate Subcommittee on Internal Security. In that Report the staff of SPXRA documented the SPX presence in recent decisions of that "guardian of the Constitution" in relation to the impact of those decisions in aiding advances of the communist movement. That Report was immediately suppressed. It was brought to public attention only

through a private organization, which printed and distributed it for SPXRA.

It was Col. Hutton who first broadcast the facts about the communist nature and Soviet support of the Castro forces in Cuba, on a nationwide hookup. It was Col. Hutton who drafted the report which told the truth about the rebellion of the Freedom Fighters in Hungary. That Report inspired a Congressional Resolution that would require free elections in the slave states behind the Iron Curtain, as a prerequisite for further cooperation between the United States and the Soviet Union. (That effort was scuttled by the State Department. So much for Congressional influence in matters involving the unholy alliance between the land of the free and the home of the slave!)

These items are but a sampling of the numerous counter-attacks by SPXRA against the revolutionary assault on these United States.

Following release of some of their Reports to those selected few patriots, officers in SPXRA became convinced that there was a need-to-know by a much larger section of the American people, and a series of study courses to bring public attention to bear on this phenomenon was begun. A quadrilogy in the form of a series of taped lectures was planned to divulge the history, strategy, tactics, pressure patterns, objectives and techniques involved in SPX. Each segment of the series addressed specific areas of enemy strategies which were taking this country at an accelerating pace into what then was described as "the communist orbit", with no knowledgeable resistance to this essential element. The hope was that, with knowledge of those strategies, the American people would be able to effectively respond to enemy penetrations, and thus forestall the forced march into servitude.

Only two of the segments of the documentaries were completed ("KNOW YOUR ENEMY and "RED EMPIRE"), when Colonel Hutton became seriously ill, and had to disband SPXRA. He died shortly after that.

As recent events have developed, Col. Hutton and his work have gained added importance. With the installation in our government of the Planning, Programming and Budgeting System, the threat SPX holds for the future has become crucial. This System is the overt embodiment of SPX, and there is no one of stature today who is putting the meaning of its use into the frame of global conquest, as Col. Hutton and SPXRA did for so long.

This book has the same core concept as prompted SPXRA's quadrilogy, but that is the limit of the resemblance. Those readers who may have been among those who received the SPXRA briefings will recognize that immediately. But if any still have the briefing papers put out by SPXRA, and review them now, they would be amazed to find how relevant they are today.

As the French put it so aptly: "La plus ce change, la plus ce meme chose"!

ADDENDA:

SPXRA Briefings; "Know Your Enemy"; "Red Empire"; "The Supreme Court as an Instrument of Global Conquest".

While SPXRA identified the Enemy as Soviet communism, that fact does not in any way detract from the work they did. In the 40s, 50s and 60s, the preponderance of evidence validated that thesis.

Information available today which indicates that the Soviets are as much controlled as the puppets they control, does not change the record of communist activities. Somehow, it seems to plumb the depths of depravity even deeper, to know there may be hidden puppetmasters, pulling the communist strings.

The Enemy, called communism then, still exists today, still pulls the strings, still continues its inexorable advances toward the goal declared by the communist leaders. That goal is the same one pursued by Adolph Hitler. It is the goal of socialists of every hue, from the Fabians to the International Workers of the World (IWW). Like-minded elitists, wishful thinkers, collaborators and self-appointed 'do-gooders' wrap it in their own brand of ideology, but march to the same drummer.

The International cabal of financiers and monopoly capitalists have that same goal. From the evidence, there is reason to believe that these are the power behind all the other movements.

The facts about that goal are as valid, regardless of the germinal source, whether it be the Kremlin, The City in London, Bilderberg Palace, the plush offices of the international bankers, or the panelled halls of the United States State Department.

Communist lackeys, whether skulking in the back alleys of Palo Alto, coming out of the closet in San Francisco, parading red flags through the State Capitol of California, or massed in the streets of Tehran, have been, and are now, doing the jobs needed to reach that goal.

No one has identified those jobs, and placed them in global perspective, better than SPXRA. No one (except, perhaps, the junior Senator from Wisconsin) came closer, in the 1950s, to exposing the real puppetmasters, than SPXRA, as they related the involvement of official departments of our government to the activation of Soviet Principle Ten in this country.

As a demonstration of the depth of SPXRA analysis, let me paraphrase for you the closing statements in that first course of the unfinished quadrilogy which SPXRA prepared in 1961. In doing this, only the date is changed (to 1989), and the names of some of the locales. This demonstrates the identic strategy still ongoing.

"If your strategy maps are properly posted, you know how gravely the global situation has deteriorated since we began these briefings.

"The first quarter of 1988 was typical of intangible Enemy gains not measured by lands conquered, or populations enslaved, but by preparation and maneuvering for such gains later.

"These pressures...are not entirely explained by the fact that State Department forces which engineered the fall of Nationalist China, 1945 -50, are again in control.

"There is more to it than that. As demonstrated by the farcical SALT talks, and proposed treaty, Enemy is operating from positions of power and assurance.

"He counts his gains everywhere, not excepting the American zone of Panama, and the turmoil in a number of South American

countries; the leverage under South Africa and its proWest government; the Cuban troops in Angola; the pressures in all of Africa; the tragic prelude to disaster in Iran and its aftermath.

"Enemy's gains do not end there. He is watching, with satisfaction, State Department's moves in the Far East, and the disbursement of his victims in IndoChina.

"Enemy is now certain he can finalize his goal at any time of his choosing. He is confident of the reaction from the American President. It is his conviction that "Be Kind to Moscow" is the theme of the American Executive, no matter who lives in the White House."

May God rest the soul of Col. Tom Hutton, who gave full measure of devotion to the country he loved, and set an example of courage and objectivity and patriotism which can only benefit all who truly treasure individual liberty and oppose communism and all its handmaidens, for exposing the fraudulent premises on which its goal is based.

Sporadic investigations of radical movements of every hue occupied official bodies in the United States for over sixty years, reaching a peak after world war 2. The voluminous hearings and reports which resulted have exposed 'communist' theory, tactics and strategies, and created an indisputable record of perfidy which almost defies belief.

While lesser co-operators in this country have been the usual target of such hearings, occasionally larger fish have been caught in the nets of committees charged with protection of the security of these United States. The involvement of such luminaries as James T. Shotwell, Owen Lattimore and Alger Hiss in this official record of subversion are indicators of a higher level of power and influence than has ever been officially documented, and of the presumption of a cabal behind them, which has remained untouched in official records to this day.

Generally, those investigations accepted the 'communist' movement as an alien conspiracy, with global conquest as its goal, and their work was limited by that concept. Three investigating bodies in the 50s which attempted to pursue the possibility of an American connection of substantive importance within the "one world" movement, were summarily halted. Those members of such committees who insisted on finding answers to the questions raised, were viciously attacked, their integrity impugned, their funds withheld, and their careers effectively destroyed.

When American citizens attempted to do the job their representatives were unable to complete, the vicious attacks were turned on them.

The infamous Fulbright/Reuther Memoranda kicked off the official beginning of "anti-anti-communist" government policy, which brought an end to legislative committees on internal security, and marked as "extremists" - irresponsible and not respectable - those citizens involved in researching and reporting on the power, influence and extent of subversive activity behind surface events. (See Ch.17.,Pt.2)

Even in the 20s, 'communist' subversion was an established fact in this country. The voluminous Lusk Report of the New York State Legislature documented the penetration of radicals into 'government' positions in that State before 1920. It was a raid on a secret 'communist' tactical meeting at Bridgman, Michigan, in the mid20s, which catapulted J. Edgar Hoover into his long career as head of the FBI.

Given the accepted thesis that that subversion stemmed from, and was directed by, the power structure in the Kremlin, which had subverted the revolt against the Czar in Russia, what could possibly have motivated the Roosevelt administration to "recognize" the collection of inhuman brigands in Moscow as the legitimate government of that benighted country?

Even in the 20s and 30s, the Russian people were "voting with their feet", as waves of refugees braved the dangers of a policed border, desperately trying to escape the most cruel oppression known until that time. There is no conceivable excuse for the Administration in Washington not to have known that tyranny was official policy in the Soviet Union, and that agents of those Soviet tyrants were actively engaged in subversion in this country.

There is no rational explanation for bestowing "respectability" on that illegitimate band of scofflaws by such recognition, unless one posits that there was a linkage between them and the superelite in this country.

It has been established that there was involvement of the 'elite' financiers in the United States and London, in the Leninist abortion of the Kerensky revolution.



The goals of 'communism', and those of the Establishment here, are compatible. The strategies and tactics of both are interchangeable. By placing American foreign policy in the frame of an intent, as acknowledged by the then-head of the Ford Foundation to Norman Dodd, Counsel for the U.S. Senate Committee investigating the foundations, to "so manage the affairs of the United States that it can comfortably be merged with the Soviet Union", it is possible to discern the logic of "recognition".

Given these factors, and that mutual goal, the question must be asked,

"How and when were the goals of the United States changed - and by whom?"

Officially, they never were. Factually, it happened in the early part of the Twentieth Century, but the American citizens were not informed of it, until Dwight David Eisenhower's Elite Committee was given the task of enunciating the New Goals for America. (See Ch. 29)

It was in response to those unannounced Goals that this nation was programmed for the managed and controlled future planned so long ago.

Only after those Goals were in place could the Planning, Programming and Budgeting System (PPBS) be activated. That System has now been installed throughout the various governments - Federal, State, Local, and, of course, in the schools. As of 1990, The PPBS is already operational on a massive scale, with only a comparative few rural areas yet to be brought on line.

It is a moot point whether its capability is not already too entrenched in this "battle for the mind", to permit a reversal. That cannot be determined until a major attempt is made to shortcircuit it.

Time is of the essence. With each passing day, exponential numbers of citizens succumb to this systematic control. Every day, inroads are being made into those few remaining non-conforming enclaves of government.

Attempts to bring attention to this truly vital movement into total control are being successfully diverted in the same way a magician diverts his spectators - by centering attention on unrelated movements.

Internationally, the issue of the "communist threat", and its multi-faceted activities, with the added confusion of so-called "democratic" movements; the quietly executed erasure of the Canadian/American border; the proposal for a "buffer" on the Mexican/American border; the continuing focus on central/American "unrest"; nationally, the NSC/Iranganate; the hydra-headed political issues, including the quadrennial 'election'; the payoff to the Japanese internees, the travails of the Attorney-General, the probes of elected officials, the radical changes in Supreme Court decisions, the so-called "drug war", and on and on; locally, the flames of long-burning issues are fanned, or new issues are whipped up to distract attention from the installation of computers, replacement of "outdated" accounting and budgeting practices, hiring of systems "experts", etc.

The hard reality of a clear and present danger is obfuscated by the lingering "threat" of the communist myth.

The world in which financiers, bankers, accountants and tax protestors move and do their thing, is a foreign country to me.

It's not that I haven't tried to understand, nor that I don't recognize the crucial role of 'legal tender' in such matters as I DO understand, such as conspiracy, treason, and suchlike liberties of sin. I do know that the love of money, and the power it brings, are at the root of all our troubles.

But I get lost in the maze of semantics which surround the m-o-n-e-y issue, so I don't write about that area of the problems besetting mankind - usually. I even try not to think about it.

Despite my blind spot, I am about to make an exception (for cause, as you will see).

Possibly the first expert to try to explain for such as me, to get us to pry open the money-made-mysterious conundrum, and find the hoax inside, was one W. H. Harvey, who created "Coin's Financial School", a fictitious establishment, back in 1894. Harvey dedicated his 'school' to the cause of making m-o-n-e-y UNmysterious.

It is not my intent here to discuss his books on finance and related matters, which I have read, but to report on one I haven't read. If there are any copies around today, they must be beyond price.

This subject book is also about m-o-n-e-y, but its main theme is the relation of money to "...a gigantic conspiracy, international in scope, conducted with vast resources, indomitable in purpose and daring, and resulting... in ends toward which the destruction of the people's money was but an initial step..." (Quote from a review by the Chicago Times, included as a supplement in Coin's Financial School "Up To Date", 1895.)

Now, as I said, "conspiracy" I DO understand. Mr Harvey apparently did, too. He must have had some inkling of suspicion that his "The Tale of Two Nations" (The Book in question) might be consigned to the non-book department, even as he wrote it, for he took the unusual steps of including the Times review of it in one of his m-o-n-e-y books, and inserting two chapters of The Tale in another!

The Times review notes that, while The Tale is a "romance", some of the characters in it are (were) real people, and some of the events really occurred. The author inextricably tangled fact together with fiction, and even thinly disguised some of the real people, so as to make them appear fictional.

Some of my contemporaries will be convinced (as I am) that there was even less fiction in The Tale than was noted by the Times reviewer. I'm sure that the following selected quotes will make the point:

"Two bankers and financial operators met in London one evening... Baron Rothe, the host, was a portly, well-fed, brainy diplomat and financier... His guest, Sir William T. Cline, like himself, was very wealthy... Both believed in the power of money..."

The Baron began:

"I wish to talk with you... about something bigger... than either of us, or all of us together, have ever undertaken... For more than a year... I have been trying to satisfy myself as to the effect a single standard of money would have, if adopted by

the whole world... I know now exactly what the result would be, and that it is feasible..."

At that point, the two went into a lengthy discussion about silver and gold, bimetallism, and legal tender - such things as your poor scribe cannot discuss. The Baron wound up with the statement that, unless her course were altered, the United States would supplant the British Empire as the creditor nation of the world, and wind up "richer than all Europe". He said the Plan he had devised would destroy that potential; that, by demonetizing the U.S. currency, the rest of his goals would be realized.

The second chapter begins with more discussion about m-o-n-e-y theory, but quickly turns to the mechanics of strategy and tactics for activating The Plan. and that's where the plot thickens.

Sir William protested that the Yankees were too smart to allow such manipulation, but the Baron smugly replied:

"This is a one man's world. ONE MAN on the Finance Committee in the Senate, and ONE MAN on the same Committee in the House, and one hundred thousand pounds, and the job is done".

Again, Sir William protested,

"I think you have underestimated the integrity and sagacity of the American Congress. The proposition will be combatted, and it will raise a storm throughout the Republic, and your agents will be powerless."

The Baron patiently dealt with this remonstrance:

"But you do not understand the conditions. ...A Bill can be presented to reform the coinage laws. ...This bill, on its face, would NOT demonetize silver, but as enrolled, it would... The interdelineation of a line, or the changing of a word, and the Bill, as finally recorded, would be as we desire it. I doubt whether it would become known for several years..."

Again, Sir William interposed an objection:

"Yes, but when they DO discover it, a cry will go up, and repeal will be inevitable. The public will..."

The Baron interrupted:

"The public be damned! Once ENACTED into law, it CAN BE MAINTAINED. Every money lender and banker in America will arraign himself on the side of the new law... Money has no patriotism. The combined wealth in the United States will support the law...they will not see the general wreck and bankruptcy that will ultimately come, pulling most of them down with it..."

"To repeal the law would require BOTH Houses, AND the President... You can risk our friends in Wall Street to take care of one of those three..."

"Sir William, I would not undertake it, were I not so sure of the woeful ignorance of the masses (alas! your poor editor!) on the subject of money."

"When the effects of (our Plan) set in, they will act like a nest of rattlesnakes in dogdays... they will wriggle and twist and bite each other. They will lay it on everything but the right thing...

"IT WILL ESTABLISH TWO CLASSES - THE RICH AND THE POOR. THE FIRST TO ENJOY THIS WORLD, AND THE OTHER TO LIVE BY WAITING ON THE FIRST. We must crush their manhood and independence by making them poor - they then make good servants and gentle citizens."

In that statement is the kernel of the goal of the conspiracy which has devastated this country in fact - written almost twenty years before this Plan was made operative in 1913!

Later, the Baron told how he would protect the co-conspirators in the American Congress:

"When Congress is about to adjourn, things are done in a great rush. In rare instances, bills are voted on without being read - an explanation being accepted (instead)... It is usual to grant a Member the right to have his speech printed in the Record, without ever having delivered it. In this way, we will have no trouble in showing afterward that the Bill, as passed, was explained to be just what it was..."

Now I ask you, gentle reader who understands m-o-n-e-y, was that what "happened" in December, 1913, when a majority of a minority of Congress approved "the Aldrich Plan", and passed the Federal Reserve Act?

(All emphases added -ed)

Addedum:

Shortly after this chapter was published as a regular column, I received a package in the mail in a plain wrapper, with my name as returnee as well as addressee. In it was a paperback copy of "The Tale of Two Nations". Now that I have read it, I wouldn't change a word of the content of this chapter.

There were four days in May in 1960 when the citizens of this country might have received vital information necessary to mount a campaign against the communist/socialist advances which, even then, were causing disruption of the social, political and economic functions of our society.

The opportunity to learn of some of the forces and programs which were taking this nation further and further from the American birthright, came in San Francisco. The House Committee on UnAmerican Activities (HCUA) was looking into the functioning of the Communist Party (CPUSA) in various areas of this country, and was holding a Hearing on the Northern California unit of the CP.

While some doubts are justified about the true nature of Soviet communism, there is no room for question as to the threat to internal security of this nation embodied in the CPUSA unit of the Communist International (ComIntern).

The "comrades" who met under discipline in secret cells in various areas of this country, took direction from a central authority, and plotted against American interests, were very real. So, too, were those individuals called "sleepers". Sleepers were communists under discipline who never carried cards, paid dues, attended communist meetings, nor openly supported identifiably communist causes. These were instructed to stay under cover, until a time of 'need', when their 'respectability' could be used to serve the Cause. Aided and abetted by the mass news media, and using the Constitutional guarantees in the Bill of Rights to protect their sabotage, these dedicated domestic revolutionaries functioned as a fifth column, within the society they intended to destroy.

It was the evidence of this fifth column which prompted a comprehensive investigation by the House Committee in 1959. Throughout the winter, the Committee had held hearings in major centers around the country, wherever there was evidence of communist penetration, and San Francisco was a fitting environment for the finale, because there was a plethora of evidence to suggest heavy penetration by the Northern California District CP.

Under orders, communist cadres placed a smokescreen around City Hall in San Francisco that May, and effectively hid the importance of those Hearings from public view.

Communist-led riots by students from the California State University at Berkeley became the central focus of the media during those critical days, and American patriots were seduced into a position of defense of the Committee and the local police, instead of learning what went on inside City Hall.

As a result, while many citizens remembered the riots, and the police turning fire hoses on the 'students', washing them bodily down the stairs of City Hall, few, indeed, could tell why those Hearings were held, or what importance they had.

"Operation Abolition" (so-designated by the Communist Party) was a concerted effort of the CPUSA to destroy the security agencies of this government, and target one was the House Committee. This was a year before Reuther and Fulbright issued their Memoranda (which will be discussed later).

The San Francisco Hearings brought a dual success to the Communists, for, while helping to attack the HCUA, the riots also clouded the issue of the Communist strategy planned for Operation Abolition of our legal government.

Karl Prussion was a principal witness called to "surface" by the Committee to make his personal witness of CP activity in Northern California public, but of equal importance was a 'silent witness' - the official documents of the proceedings of the 17th Convention of the CPUSA, which were submitted in evidence at the Hearing. Those documents laid out the CPUSA plans for their future action in this country. Had the CPUSA program received the attention it deserved, at that time, the history of the intervening years since could well have been different.

In his testimony, Prussion (a card-carrying CP member for 26 years, 12 of them as an undercover agent for the FBI) described from his own experiences in communist cells in Northern California, and particularly in Palo Alto, the actual workings of the CP in local areas, through Party functionaries.

He told of communist penetration of civic groups, political organizations and educational, social and business institutions, and CP ability to move such groups toward communist goals.

He described the CP directives for Party members to move into the major political parties (especially the Democratic Party), and told how they should function there, supporting "forward-looking" candidates (read, "communist-supporting"), and setting the goals of the political clubs to further communist ends.

He testified about those "secret" communists, who are not part of the regular Party apparatus, but who work, wherever they are, for Party goals. These, said Prussion, are "usually a doctor, a lawyer, a political officer, or in some other professional field".

Prussion's testimony, taken in conjunction with the Convention documents, shows clearly how and why this country has arrived at its present precarious position.

For it was at that 17th Convention that the CPUSA committed itself to work within the framework of our Constitutional government to achieve their socialist goal. In so doing, they were responding to the Call issued by Nikita Khrushchev to the 20th Congress of the Central Committee of the CPUSSR in 1956. That Call was for world communism to create the conditions in target countries, by which it would be possible to take them to "socialism" by parliamentary means. It was through this very strategy that the Communists took over Czechoslovakia "without a shot being fired".

The parliamentary road to socialism was not new. The Fabian strategists had developed sophisticated techniques which were used successfully in England, and were brought to this country by crusading socialists long years ago. Joined by other leftist organizations with no known connection with either the Fabians or the CP, a United Front was formed to assure success.

The CPUSA documents presented to HCUA in San Francisco called for "working class rule" (read, "election of communists") in the legislatures at federal, state and local levels, to extend their power within the government.

It was also at that Convention, that the CPUSA declared their intention to form a "transitional government", building the framework of their brand of socialism WITHIN THE EXISTING SYSTEM, by social legislation, and by changes in the system, itself. That framework is now in place. It is known today as "regionalism".

The Convention called for a number of specific programs, many of which are also fait accompli.

Most important was the refrain running all through their program, of the takeover of representative bodies through the political process. That this has been eminently successful is demonstrated by the increasing

evidence of a Congress unresponsive to the citizens; by State legislatures working their will despite citizen protest; and by local officials subserviently acquiescing in social programs imposed from above.

The utter futility of appealing to 'representatives' whose loyalties are already assigned to another goal, must be obvious. How can citizens EXPECT redress of grievances, from ideologues dedicated to the cause of the difficulty?

The handwriting is on the wall. It is not too late for Americans to turn this situation around, but it will not be done without attacking the problem at the source.

"Operation Restoration" must begin by replacing those legislators at every level who have contributed knowingly to Operation Abolition, with local citizens, whose support of American principles is a given. Those legislators who have "gone along to get along" must be shown the error of their ways.

Informing those who are supporting the programs of the CPUSAs "transitional government" (whether deliberately or through ignorance of the goals and/or objectives of that "overlay" government), that such action will no longer be tolerated, is a must.

Addenda:

See HCUA Hearings, "Northern California District, CPUSA" May 1960

Recommended Reading:

"And Not a Shot is Fired" Jan Kozak, LongHouse Publishing, 1962

When Karl Prussion surfaced at the HCUA Hearing in San Francisco, after spending most of his adult life in the shadow world occupied by communists in this country, he learned something too little known. He noted that, in the dark world of the CPUSA, there was no knowledge of an even darker world of influence, behind communism.

Like all who serve the Comintern, he had thought the push for one world stemmed from the Kremlin. Once free of communist discipline and his FBI obligation, he began to recognize a hidden hand, even more powerful than the Politboro, operating inside these United States. This, he said, he found exemplified in the Council on Foreign Relations (CFR).

Surfacing, as he did, before the House Committee on UnAmerican Activities in San Francisco, Prussion was concerned that the communist-led effort to abolish security agencies would succeed, and he felt continued oversight of the communist movement by official bodies in the government, was essential to our security.

And yet, one may question the effectiveness of those investigations. Certainly, today, the complexion of Congress would almost be a guarantee of non-productive hearings.

Returning, at this late date, to musty reports of the Committee, and its counterpart in the Senate, one is struck by an incompleteness in them. Were the Members aware of that other world behind communism? If so, it is not apparent in their records.

One is led to wonder whether the emphasis of those investigations was somehow deliberately kept on communism, to prevent premature disclosure of the many parallels between it and the invisible groups who seem to control both the Kremlin and the government of the United States. The only investigations which began to reach out into that darker world were abruptly terminated by means of a number of assorted strategies.

So long as communism was the only concern, only communists and their sympathizers made waves about investigations. When those probes went beyond communism, a deluge of vituperation poured from the highest levels of our government - and even originated within the Committees, themselves.

The evidence of the influence of this darker world, in those times, was almost intangible. It existed mainly in such areas as the "recognition" of the Soviet Union; in "cultural" exchanges; and in successive administrations here constantly supplying the Soviets with everything they needed to remain a threat to our "security". The chances of this 'just happening' are astronomical.

This has vital significance, and nowhere more so than in education.

Augustin Rudd, long time head of the Sons of the American Revolution, also headed an early group of concerned citizens, formed to protest the "Building America" series of textbooks which were placed in American schools in the thirties. In his book, "Bending the Twig" (1940), which resulted from the research he did to prepare the case against the texts, Rudd documented Soviet manipulation of education after the coups in Russia.

According to Rudd, Soviet interventions in education included destruction of the former methods of instruction, and replacement of them by "progressive education" (spawned in the United States by comsymp John Dewey and his coterie of fellow socialists at Columbia University). The result was a generation of Soviet youth which, when they left school, could not read, write, or cipher. Juvenile delinquency became a major problem in the Soviet Union, and there were bands of non-productive young people



roaming the steppes, robbing, looting and using violence against any who got in their way.

After that generation of Russian children had been thoroughly perverted by this system, the Soviet schools were returned to "traditional education" - but completely controlled by the State, and no longer designed to produce individuals who could think for themselves. They now produced the vaunted "Soviet man".

As Soviet schools became models for production-line indoctrination, American educators (some of them trained in Moscow) began to direct American schools into the system which had proven capability for destroying national culture and heritage, through conditioning the minds of the children.

When American children had been led down the same path, for the same purpose as in the Soviet Union (but for THIS NATION), the powers that be here began to prepare the transition back to "traditional education" - with a difference from OUR tradition, but none from that applied in the Soviet Union.

The mind control techniques of Pavlov, made more effective through the use of computers, were now ready to turn American children into compliant "Citizens for the 21st Century".

This being a given, it is in character for the administration in Washington which identified the Soviet Union as an "evil empire", to begin "exchanging" our children and theirs, our teachers and theirs.

It has taken longer here, than it did in Russia, to create a generation unable to read and write, or adjust to adulthood, mainly because of our diversified culture. It wasn't possible to turn America overnight into a police state, as was done in Russia. It wasn't possible, here, to murder millions of people, and, in so doing, "eradicate the poisonous influence" of the older generation\*\*. It wasn't possible, here, to physically destroy those with leadership qualities - their capabilities had to be destroyed in other ways. Like Joseph McCarthy. And others we will name.

The point in time has now been reached when anything is possible. The transition has begun.

THE "ONE PARTY" CONTROLLED ECONOMIC PLANNING SYSTEM IS A FACT OF LIFE HERE, NOW. It operates through American 'soviets' designed by agents of the "1313" planning conglomerate, and known as "Councils of Governments". The control system is also in place, already installed in the education system, being finalized now in all government, operational through the regional planning structure.

Older citizens, who knew the way America once was governed, have been isolated by means of a contrived "generation gap". The years, too, have taken their toll, as surely and inexorably as the Soviet murderers, although not so swiftly. Many who recognized these changes and resisted, are now gone, or too old to be active.

The machinery for the centrally controlled police state is in place, and our once-proud "thin blue line" - our local police - has been conditioned to control the citizens they were hired to protect, should any be so bold as to start a counterinsurgency movement, when they learn the truth about their "government".

Representative government at any level is no longer a constraint on this revolution, as those elected to Congress vote for "revenue sharing", and present incumbents in local offices (without regard to Party or promise) grab for 'federal funds', and accept the controls which accompany them.

Only the grassroots remain as a threat to the finalization of the Elitist "impossible dream". But those roots are stirring, and evidence of

their strength is abundant. They may yet demonstrate their ability to strangle the despoilers who would make barren our land and remove forever the last bastion of hope for a world where everyman can reach his own potential.

It can be done, but there is one fundamental necessity.

There are not enough Americans YET, who know that it needs doing!  
Those who DO know have their work cut out for them!

Recommended Reading:

The William Alanson White "Lectures on Mental Health", Brock Chisholm, "Enduring Peace and Social Progress" - 1945

"Bending the Twig", Augustin Rudd, S.A.R., N.Y. Chapter, 1957

Addendum:

"Comsymp" - communist sympathizer

THE MYTHS OF COMMUNISM - 17 - Joseph Raymond McCarthy  
Part One  
( 1908 - 1957 )

"Who steals my purse steals trash -  
"'Tis something, nothing -  
"'Twas mine, 'tis his,  
"And has been slave to thousands.  
"But he who filches from me my good name  
"Robs me of that which enriches him not,  
"And makes me poor, indeed."  
(Shylock - Merchant of Venice)

The oldest child born after world war 2 would be 45 years of age in 1990.

None of these "postwar babies" or, as they have come to be called, "Baby Boomers", could have had any awareness of the career of Senator Joe McCarthy at the time he served them in Congress, yet all of them probably know his name.

Most citizens today probably equate that name with "evil", and accept the modification of "McCarthyism". Few, in all probability, have found reason to go to the record, and discover for themselves what 'McCarthyism' was all about. Were they to do so, they would assuredly be puzzled.

Those who would seek out the record might be inclined to ponder how their world would have been, had Joe McCarthy's findings, as Chairman of the Senate Permanent Subcommittee on Investigation of the Executive Department received continuing examination. Had those findings been given the careful consideration they deserved, there is no way to know, now, where they would have led.

A seeker for truth might question why many of the men who were responsible (as McCarthy was) for the security of this nation, turned on him, and helped to hound him to an early grave, while those whom he was charged to investigate continued on in positions of power and influence.

To students of subversive movements, it is a known fact that, in this total war against established institutions, little effort is ever expended on denying charges against collaborators or cooperators in that subversion. Instead, the ancient tactic of "If you don't like the message, kill the messenger" is activated. The full force of tactical warfare is brought to bear on those who expose specific subversive acts, or specific subversive individuals, and it is impossible to pinpoint the source of the volleys. No one was more aware of this than the junior Senator from Wisconsin.

During world war 2, as an air force officer, he had been trained in "Intelligence", and he had commented on this tactic before he, himself, became the "messenger".

When he was warned by an aide that it wasn't politically expedient to publicly expose those in high places whose coattails were tainted, the Senator replied, "Look, that is one argument I never want to hear again ... The question is not whether it is good for me, or bad for me, but whether it is right or wrong, as that is the only thing that matters to me in my life."

Perhaps that one statement sums up the character and strength of Joe McCarthy, more than all the words ever used in all the talk about him, pro or con.

For Joe McCarthy was a man. His fondest admirers might not call him a "gentleman", but even his worst enemies admitted the strength of his

character.

He was a man, and an American. And a strange thing happened after his death.

This man, this Senator, this American, who, in life, had been the target of the most vicious unjustifiable verbal attack ever recorded against a human being, was given a "State Funeral", with all that that implies. His casket was carried into the same Chamber where, so short a time before, his colleagues had voted to censure him.

There, on the Floor of the United States Senate, the memorial service was held for this man, who so loved his God, his Country, and his honor, that he could not turn his back on any of them - not even to save himself.

This was a rare tribute, this State Funeral. A majority of the Senate had to approve such a service. It had been seventeen years, at the time of McCarthy's death, since any Senator had been so honored. Many Senators who joined in the attack on McCarthy, have gone to their final judgement since that day. Not one of them received this tribute.

Joe McCarthy loved his Country. He volunteered to serve it in world war 2, and volunteered again, when, as a United States Senator, he saw it endangered again. Neither time was he ever known to give an inch to the enemy.

All the 30 months he served in the acknowledged war were in Intelligence, which undoubtedly prepared him for the job he found necessary, when he became Chairman of the Committee charged with investigating the Executive Branch of the government.

In the acknowledged war, Joe McCarthy earned a Distinguished Flying Cross and five Air Medals. In the unrecognized war, shame and abuse were heaped on him while he lived, and, except for that short time after his death when he received the highest honor the Senate could bestow, he has not been permitted to rest in peace.

His enemies continue to kick his coffin, as though to assure themselves that the spirit of Joe McCarthy shall not rise again.

After the "shivering, quaking patriots" in the Senate - who would not stand by him when he needed them - proclaimed him in death the hero that he was, it became very apparent that they might have created a martyrdom for Joe McCarthy, making of him, in death, the rallying point which had been forestalled, while yet he lived by the smokescreen of vituperation. So the attacks began again, and they continue to this day.

The epithet 'McCarthyism', coined by the communists in this country, has found its way into the history books, the dictionaries, the textbooks, and the minds of succeeding generations of Americans.

The sizeable black bound volume, privately printed, which contains the eulogies given at the Senate funeral service for this indomitable fighter, should be on the shelves of every school library, for students to use in comparison with their history books. There, in its pages, in the words of his colleagues in the Senate, both friend and foe, "McCarthyism" glows through in its reality - as the epitome of patriotism.

Recommended:

MEMORIAL SERVICES, Remarks presented in Eulogy of Joseph Raymond McCarthy - Publ: National Weekly, Inc. 1959 (These Remarks were culled from the pages of the Congressional Record, and may still be found there).

### The Exorcists

Each year since 1957, around the Ides of March, the curtain goes up on a round of weird rituals. Few Americans recognize significance in the sequence of events - if, indeed, they consciously realize a relationship in them. But significance exists. It is subliminal in nature, but these rituals serve to keep the American people alert to what happens to those who, like Joe McCarthy, refuse to compromise with evil.

The rites begin with saturation reporting by the media of a rash of 'rightwing extremist' or 'terrorist' activities, which range from 'racist' incidents, through pseudo-nazi eruptions or confrontations, to the resurrection of some doddering old man, identified as a former agent of Hitler. Hauled from obscurity in some strange halfworld where he has managed to elude detection through the years, this 'criminal' is then exhibited at a showtrial, for atrocities allegedly committed half a century before.

All of these incidents lead to the annual gravekicking ceremonies, culminating on May second (the anniversary of the death of one who has been made to appear the epitome of 'rightwing extremism').

It is vital that Americans recognize this campaign for what it is - a classic example of mass brainwashing and mindchanging.

Minimal research into McCarthy's career disproves the "facts" about him which have been emplanted in the public mind. The creature called "Joe McCarthy" today is the equivalent of a voodoo doll, created to serve as an effigy, by means of which the darts of hate can be aimed at the vitals of every patriot bold enough to walk in McCarthy's path.

The gravekickers who annually perform this ritual are determined to destroy the last vestige of that innate spirit in McCarthy such as prompted the poet's question: "Breathes there a man, with soul so dead, who never to himself has said, 'This is my own, my native, land'?" For them, that spirit must be exorcised, to permit the finalization of the New International Economic Order (NIEO) with its end to nationhood.

So long as there is a trace of that love of country left in the heart of Americans, the possibility exists of zealous devotion to a priceless heritage prompting an effective counterforce to the revolution. That thought sows seeds of terror in the ranks of the revolutionaries.

How effective this brainwashing campaign has been cannot be fully realized, until the pages of time are turned back, and the temper of the forces on both sides of the political spectrum are examined. So let us turn back, to the point in time when support of this psychopolitical strategy was officially incorporated into administrative policy of the United States government.

It was 1961. John Kennedy was in the White House. Robert Strange McNamara had moved back into the Pentagon, where he was slipping a management and control system into the Department of Defense, "like a torpedo into a tube", as Rose Martin (talented author of "Fabian Freeway") described it. General Edwin Walker had been cashiered out of the Army for implementing an administration directive to train troops under his command in the virtues of their government and in the strategies of psychological warfare (psywar), to protect America's sons from another "Korea".

On the second of August, Senator Strom Thurmond dropped a bomb on the floor of the Senate, which rocked the Ship of State. He entered into the

Congressional Record the text of a secret memorandum, which had been given only to the Resident of the White House, and to the Secretary of Defense. Somehow, it had been partially 'leaked' to the Washington Post and the New York Times, and the Senator did not rest until he obtained a complete copy.

The content of that Memorandum gave Americans their first intimation that "we, the people" were considered, by at least a segment of officialdom, as "the enemy".

That secret document became known as "The Fulbright Memorandum", after the Senator who finally admitted authorship. It was based on the premise that:

"In the long run, it is quite possible that the principle problem of leadership (in the U.S.A.) will be, if it is not already, to restrain the desire of the people to hit the communists with everything we've got, particularly if there are more Cuba's and Laos'."

With Vietnam already on the back burner in 1961, the administration moved quickly to implement the recommendations in the Memorandum, which dealt mainly with the involvement of the military in "cold war informational activity", rousing the public "to the menace of the cold war", resulting in public opposition to both foreign and domestic administration policies.

The Memorandum noted that the administration's social legislation was being equated in the public mind with socialism, and the latter with communism. (No recognition was made of the true purpose of administration policy, which is a return to feudalism on a world scale.)

The Memorandum recommended the "muzzling" of military officers; clamping civilian control over seasoned military personnel; diminishing the role of the military in high level policy, command and staff functions; requiring civilian control of the content of such activity as General Walker's "ProBlue Program". What that "civilian" control would be is suggested by the further recommendation that military personnel be required to complete graduate studies in history, government, and foreign policy under "civilian educators".

The dust had hardly settled from that bomb, when a second Memorandum surfaced, which extended the concerns in the Fulbright Memorandum to their logical conclusion. THIS Memo was distributed to top Kennedy administration officials, and "certain sympathetic Senators and Congressmen" by Walter Reuther, and it became known as The Reuther Memorandum.

This second Memo consisted of specific recommendations for "immobilizing the radical right", which was characterized as "an unknown number of millions of Americans of viewpoints bounded on the left by Senator Goldwater, and on the right by Robert Welch", who, it said, were "probably stronger and almost certainly better organized than at any time in recent history".

Reuther's Memo called for:

\* deliberate administration policies to contain those 'millions of Americans', and to reduce them to a lunatic fringe, no longer able to "obstruct the accomplishments of the administration";

\* the press, television, church, labor, civic, political, and other groups were to carry the prime burden in this effort,

with affirmative administration policies and programs to set the backdrop against which this private activity could succeed;

\* a shift from defense of government response to the Fulbright Memorandum in deactivating the program to train troops in patriotism and psywar, to an offensive which would include determining how widely 'radical right' infection had spread in the armed services;

\* elimination of the Attorney General's list of subversive organizations, or, at least, inclusion of 'right wing' groups as also being subversive;

\* damming the flow of money to the 'right wing', including, but not limited to, eliminating the use of tax exemptions and corporate funds in advertising the "threat of communism";

\* a positive campaign to minimize the threat of "domestic communism", and thus reduce tension and existing conceptions of the communist threat".

To my knowledge, this was the first time "millions" of Americans loyal to their country were identified (officially or otherwise) as a "lunatic fringe" and/or the "radical right", but it soon became policy for every activist supporter of the administration, and the administration itself.

The arrogance of this labor leader in assuming that the press, television, church, civic, labor and "other groups" would "carry the prime burden" of this attack on millions of Americans can only be understood to imply that he had the means to ensure their participation.

To implement these proposals, after years when official policy had "maximized the Communist problem", it was necessary for the administration to do a hundred and eighty degree about face, and take a wholly different attack on that problem. It did so, without missing a beat.

Suddenly, the pressure to do away with official committees investigating "communist" activities; suddenly, the new drive against the anti-communists; suddenly, elimination of the Attorney General's list of subversives and their organizations; suddenly, the CPUSA no longer a threat; suddenly the Soviets were "mellowing"; and, gradually, the ghost of Joe McCarthy became a vehicle to reduce those "millions of Americans" to a 'lunatic fringe'.

One by one, militant patriots found there was no room for them in "respectable" society. More and more, less militant, but no less patriotic, Americans retreat into 'apathy'. Ever more obviously, there is an increase in the paralysis of the American will to resist. Ever more insistently, administration after administration moves this country toward the day when it can comfortably be merged into that New International Economic World Order.

No threat from within?

Bah! Humbug!

Recommended reading:

The Fulbright and Reuther Memos - at your Public Library

THE MYTHS OF COMMUNISM - 17 - Joseph Raymond McCarthy  
Part Three

THE LEGACY

Each year, as the Media begins its profane litany, which rises to a crescendo as the anniversary of Joe McCarthy's death approaches, it would be the better part of wisdom for Americans to look beyond what is being said, and seek out what is not. You may be sure that what is NOT told - not wanted known - is what is important.

"McCarthyism" was invented to create a false image of the man whose name still comes to mind, whenever "the junior Senator from Wisconsin" is mentioned. That man had the potential to lead America back to its rightful course. He was

"...genuinely, patriotically, devoted to the Nation, to its flag, to its interests as he saw them, to its welfare as he felt it, to its future as he interpreted it - with all the strength of his convictions."

That quote is from the eulogy given at his funeral by the other Senator from Wisconsin, whose name is all but forgotten today. Alexander Wiley was not a supporter of McCarthy's, but if what he said about him after he died wasn't a description of a dedicated patriot, what IS?

And that is the legacy of McCarthy. Patriotism.

It wasn't the speech he made in Wheeling which sparked the get-McCarthy movement. It was what the Establishment made of that speech (and why). They played the numbers game to divert attention from the real issues McCarthy raised that night.

What did it matter how many communists McCarthy said were in the State Department? ONE was too many, and one had already been exposed - and not by McCarthy. That one (Alger Hiss) had been protected by his colleagues, including the Secretary of State, Dean Acheson, himself. No. The issue of communists at State was the least of what McCarthy spoke about at that Lincoln Day dinner in Wheeling, so long ago.

He spoke of how great it would be, to be able to talk about peace with those who came there to honor Lincoln - but there was no peace.

He said the world was split into two increasingly hostile camps. He said;

"You can see it, and feel it, and hear it - all the way from Indochina and Formosa, to the heart of Europe."

And this was ten years before Vietnam. He said the cold war was

"...a war between our western, Christian world, and the atheistic, communist world", and that it was not political, but moral.

And that was his theme, that night in Wheeling.



He said the Marxian idea of confiscating the land and factories, and running the entire economy as a single enterprise was "momentous", but not OUR way. He said the Leninist one-party police state was not our way. But, he said, if that were all, we could still live at peace in the same world.

The real, basic, difference, he asserted, lay in the "religion of immorality" which would "more deeply wound and damage all mankind than any conceivable economic or political system". And he proceeded to delineate the facts about communism which lead inexorably to this conclusion.

It was those facts which led McCarthy to denounce those in this country

" ... who, blessed with all the good things of life which derived from our system - wealth, the best homes, the finest education, prestigious jobs in our government - used the power and influence these things brought, to perform traitorous acts." McCarthy told the crowd which packed the hall in Wheeling:

"One thing to remember is that we are not just dealing with spies, who get thirty pieces of silver for stealing blueprints. We are dealing with a far more sinister activity, because it permits the enemy to guide and shape our policy."

He spoke of the hundreds of millions of people, and vast areas of the world, which had succumbed to communist domination, and said:

"Today we are engaged in (that) final, all-out battle between communistic atheism and Christianity, and...the chips are down."

THAT was what the speech at Wheeling was all about.

The issue of communists in the State Department was just used to demonstrate one arena of that all-out battle, and McCarthy did not originate that issue! Our official Intelligence agencies had already certified 300 people in State as probable security risks, but only a handful had been discharged. McCarthy was not 'exposing communists'. He was only citing public information. What importance did the figures have that were thrown at him - 205, 79, 285, 57? They were diversions - nothing more.

But McCarthy was destroyed, the Senate diminished, the investigative function of our government emasculated, and the cold war is all but over, now.

Time has vindicated the junior Senator from Wisconsin, but he is still not permitted to rest in peace.

The amorality of communism has infested the whole world, reached into every American home, permeated our government at every level, and this man, who only wished with all his great heart to rouse the American people to face that danger, has been made to appear to be in the same category as Benedict Arnold.

Only a rekindling of the spark McCarthy lit in the hearts of those who saw through the Media blitz to the real issues, setting ablaze the "bright flame of patriotism" in all men of good will - only that spark can save this country and its people, and, in so doing, the world.

Then, the legacy of McCarthy will once more be honored, and the junior Senator from Wisconsin can finally rest in peace.

The Censure

The Constitution of the United States of America provides for either House of Congress to "punish" one of its Members for "disorderly" behavior.

In a rare exercise of that provision, Senator Joseph McCarthy was censured in 1957.

In the intervening years, his very name has been made a symbol of shame.

The question must be asked - and answered - WHY?

WHY was he censured?

WHY has such contumely been continually heaped on him for all these years?

WHY must these modern-day Franksteins keep breathing life into the monster they, themselves, created?

Joe McCarthy exemplified the righteous indignation any patriot would experience when faced with the challenge of a tyrannous intent to transform a government constructed specifically to provide and protect individual liberty, into one designed to manage and control every facet of the lives of its citizens.

Once this is understood, many will join in the fight to restore the heritage of all Americans. Some will be motivated by the need to defend their country. Some will join to forfend the alternative. Diehard ideologues will be inspired to step up their offensive to meet the challenge, and "summer soldiers and sunshine patriots" will opt to imitate the ostrich, as they always have, when the heat of battle makes its demands.

Another part of the reason those questions remain unanswered has to be that Joe McCarthy in all innocence had stumbled into the most strategic area of enemy action within our government. That area was also the most unlikely place to find an enemy redoubt created and functioning - within the military departments - the very core of the protective arm of government.

A seldom noted fact in the record of the McCarthy years is that, up to a point in time the attacks on him were no greater than those accorded anyone bold enough to identify communism as an evil force and a clear and present danger to this country, and to bend their efforts toward its elimination as a threat.

It was only after an insignificant young army dentist named Peress became the focal point of the investigations of the Subcommittee of the Senate Internal Security Subcommittee which McCarthy chaired, that the roof fell in.

The details of "Who Promoted Peress?"\* are a matter of public record, and far too cumbersome to report here. Suffice it to say that McCarthy did not accidentally, deliberately, nor maliciously select out Peress for scrutiny. Nor was the Army HIS selected target.

Information came to his Committee from a high ranking General of the Army, of a possible breach of security in his command. McCarthy's reaction to this intelligence was no more - and certainly no less - than was required of him as Chairman of the Senate investigation into possible

subversion in government departments. But his response triggered the vicious assault on him which continues to this day.

An interesting facet of that assault is that there was never enough "on" McCarthy for the facts to speak for themselves. Its perpetrators had no compunction - and certainly no mercy - about creating charges against him out of whole cloth, even including fringe benefits, such as the charge that he was responsible for the investigations into subversion in Hollywood. McCarthy had nothing to do with that. Those Hearings were not even a Senate proceeding - they were conducted in the House!

After Peress, the assault on McCarthy came from every encampment where anti-anti-communists could be lodged - even from the highest office in the land.

Again, the logical question has to be "WHY?"

If there was even a possibility of subversion within the ONE Department of government in which, above all others, subversion would be a clear and present danger - the security force itself - the normal reaction would be to trigger a red alert, and an all-out inquiry. WHY did the administration then in office not demand a complete investigation, and provide every facility of assistance? Why did it, instead, turn its wrath on the investigator?

McCarthy never learned the answer to that question. Nor has the Senate as a body ever had an answer - nor the House - nor concerned Americans. But, of course, there IS an answer. Part of it may be found in the following statement made by Dean Acheson (in his autobiography "Present at the Creation"). In discussing the replacement by Congress of the War Department with the Department of Defense, Acheson had this to say about the Executive Order (NSC-68) which impacted the newly merged services, and also created the National Security Council (NSC):

"...The purpose of NSC-68 was to so bludgeon the mass mind of "top government" that not only could the President make a decision but that the DECISION COULD BE CARRIED OUT... NSC-68, a formidable document, presents more than a clinic in political science's latest, most fashionable, and most boring study, the "decision-making process", for it carries us beyond decisions to what should be their fruits, action..." (NSC-68 was a secret executive directive, as Acheson makes clear - emphasis added)

Acheson's book was published just months before citizens (in 1969) uncovered the evidence of The System which emanated from the bowels of the unified service department. Had that book been published AFTER knowledge of the existence of the "decision-making process" (euphemism for The System - PPBS), that statement would probably have been deleted, for those carefully chosen words were recognizable then, as a hallmark of The System.

The National Security (sic) Act of 1947 was debated under false pretenses. The main focus in the debates was the semantics of "War" versus "Defense", and the issue of a single department instead of a diversified service was debated on the basis of "efficiency and economy". No whisper was heard of a unified command being essential to the structure for management and control of the "decision-making process", nor, indeed, that this was the true reason for reorganization of the military.

NSC-68 created that secret unit within the Department, which, from the record, was intended to lay the groundwork for the System once known as

Planning, Programming and Budgeting. And it did - but that fact was never officially disclosed. This unit was hidden in the unending labyrinth of the unified command, and is the recipient of unlimited funds Congress appropriates for "defense", for which no accounting is permitted. (See DoDChart, Exhibits)

Because of this planned evasion of accountability, The System was able to incubate sight unseen, unmonitored except by the adepts chosen to develop it. Those adepts, in turn, were sent out to create prototype units of The System in selected target areas.

Robert Strange McNamara was sent from that unit to Ford Motor Company, where he used The System to design the Edsel. After that, he was returned to the Pentagon to head the team designing The System for the military.

Charles Hitch was sent from that unit to California to take over as CEO of the State University complex there, to form a task force for cooperation in interstate systems initiation, begin creating the structure for systematic control in the education system, as well as to develop the skilled systems personnel which would be needed to operate The System.

A little-known fact of Hitch's occupation of the Office of Chancellor of the colossal University of California was his creation of a Task Force to develop a comprehensive management and control system for "twelve Western States".\*

Roy Ash left that unit and was given a government contract to use The System to design "modern" submarines - a contract which resulted in a disastrous situation, with astronomical cost overruns, and a submarine even less effective than the Edsel was in automotive design, which also had to be scrapped. When the flap from that experience died away, Ash was appointed head of the Bureau of Management and Budget, to oversee the construction of systematic structure for the entire country.

Under the unified military command, that Special Unit created a Special Staff Section in DoD on Psychological Warfare (psywar). Spinoffs from this Section were set up in each of the Services, and the interlock is obvious when the chart supplied by the Defense Department, which shows the chain of command, is carefully studied (see Exhibit). In that Chart:

\* The Army claimed George Washington University (GWU) as one of its psywar units. GWU was the agency which channeled The System into State and local governments, as a pilot project.

\* The Navy claimed RAND Corporation as one of its units. RAND was the instrumentality for practical application of The System.

\* The Air Force claimed the Medical Research Institute at Bethesda as its Psywar Division. Bethesda has posed problems for the resistance for over thirty years.

From this secret activity have stemmed the strategies by which this great nation is being suborned to accept the "piecemeal" transition into a completely managed and controlled society, peopled with automatons, conditioned to respond predictably to every command of the ruling junta, preparatory to amalgamation of the United States of America into the New International Economic Order.

And McCarthy was censured! Can you imagine how the course of events would have been, had McCarthy been permitted to follow the thread of subversion which the Peress matter could have disclosed?

But McCarthy was censured:

\* for "failure to cooperate" with a subcommittee which didn't exist when the decision was made to "punish" him.

\* for "abusing the subcommittee and its members", when that subcommittee was stacked with partisan opponents, who constantly baited the Senator.

\* for "obstructing the Constitutional processes of the Senate", when he had never been known to violate even a RULE of the Senate, before it was decided to "punish" him.

The original charges against Joe McCarthy had to be dropped for lack of substance. The resolution which was finally voted on consisted of charges against his reactions AFTER the move to censure began!

But the charade of McCarthy's 'censure' halted the investigation which began with an insignificant young dentist, which might have exposed the most vital issue of this century.

Who will bring charges against the cooperators in this demonstrable assault on the liberties of the American people, and on the citadel of liberty itself?

Joe McCarthy died on the second of May, 1957, at Bethesda Hospital, of "Hepatitis, acute, cause unknown". It was at Bethesda, too, that the first Secretary of Defense, James Forrestal, fell (or was pushed or thrown) from a window at the hospital, to his death.

There is substantive evidence that Forrestal was wrestling with a "momentous decision"; that he was taken to Bethesda by officials in the Administration against his will; that his diaries were spirited to Washington without his consent, and meticulously expurgated before being released. Could that decision he was considering have been to expose what he learned about The System, after he became Secretary of Defense?

Is it strange that, when Richard Nixon was ill after being hounded out of the Presidency, and refused to be taken to Bethesda saying he would never come out alive, that some Americans remembered Joe McCarthy and James Forrestal?

Is it strange that some Americans still wonder why no autopsy was performed to determine that unknown cause of McCarthy's death, so he could be legally interred?

Is it strange, then, that some believe the assault on McCarthy had a far more important impetus than is evident from the public record?

Is it not strange that the predictions made, in the eulogies to the junior Senator from Wisconsin (that he would be more honored in the future than while he lived) are coming true - at least in the hearts of Americans who love the land he loved, as deeply as he did, and who are learning the truth about "McCarthyism"?

Recommended Reading:

"Who Promoted Peress?" Lionel Lokos, Bookmailer, 1961

"The Strange Death of James Forrestal", Cornell Simpson, Western Islands, 1966

"The Forrestal Diaries" Viking Press, 1951

"Where Governments Merge", Report of the (California) Institute for Governmental Affairs circa 1969

"Psychology in the World Emergency", Lectures, University of Pittsburgh Press, 1952

THE MYTHS OF COMMUNISM - 17 - Joseph Raymond McCarthy  
Part Five

The Bright Flame

In Everyman there is a longing for the respect of his fellows. None felt this more keenly than Joe McCarthy. He was a perfect target on which to smear the tar of disrepute, for he was a caring man. He was a patriot, and deeply religious. He possessed strong traits of character which are most admired in normal societies: honesty; decency; kindness; loyalty; forgiveness; honor; duty. Even his enemies admitted this in the tributes paid to him as he lay in his coffin.

He was a United States Senator, with the power and influence of the Office to give weight to his work. Additionally, he was Chairman of the Senate Subcommittee charged by his fellow Senators with the responsibility of investigating possible penetration by subversives of the federal Executive Office. McCarthy's committee was bringing to light the scope and nature, the personnel and forces, at work promoting the transition of this country into just a unit in a world conglomerate of other units which once were sovereign nations.

There must have been great glee among his enemies as they plotted their course in planning the destruction of such a man. They chose to attack him where he, himself, would most keenly feel the blows - and where every true American would also be vulnerable. If patriotism could be made to seem base in THIS man, who burned with an unquenchable fire to protect the land of his birth and to preserve the unalienable rights of his fellow Americans, numerous objectives of the would-be rulers of the world would be served.

As a matter of fact and record, most of the objectives of his attackers were obtained:

- \* removal from the battlefield of the most effective opponent they had ever encountered;
- \* destruction of the security programs in government;
- \* diminishing the power of the Senate as a preliminary to emasculating it;
- \* creating fear of reprisal among others who would resist the revolutionaries.

Only two objectives were left almost untouched. Love of God - and love of country. These die hard. So, annually, the enemies of the man called Joe (who are also the enemies of every freedom-loving individual) bring out the specter of "McCarthyism" - a specter created for the purpose - to remind Americans of the power they wield, and to imbed in the public mind the concept of the futility of opposition.

Along with the periodic coffin-kicking, there is always a spate of 'rightwing' insurgence of some obnoxious nature as we described earlier:

- \* caches of arms 'discovered';
- \* 'Nazi' activity stepped up;
- \* a surge of 'racism';
- \* attempts to tie legitimate protest against 'government' oppression to these phantom maneuvers;

1989 was no exception. In midFebruary it began, with an hour-long "documentary" about the 'McCarthy years', followed by a rash of "news"

stories on activities of neo-Nazi "skinheads"; another hour long "documentary" in midMarch, titled "An American ISM - McCarthyism", scenes from the McCarthy years interspersed between derogatory statements by reconstituted radicals of the time, now 'respectable' citizens; an all-out confrontation in California over gun control and the Second Amendment; and a two-hour long "documentary" about retrieving treasures purported to have been confiscated by the Nazis. 1990 was a carbon copy.

The Fulbright/Reuther Memos recommending destruction of the "conservative rebellion" are still being honored!

His enemies remember Joe because they must. Destroying him - over and over - is the best weapon they have to beat down the continually rising opposition to 'the impossible dream'.

Patriots, too, should remember McCarthy for what he really was - the symbol of the fight for freedom. It is right and proper that the American flag should be flown by them on May Second - the anniversary of his death - as a symbol of the unalienable freedoms which are their birthright.

The governors and those in control of events today soil that flag by using it to commemorate the death of a Dean Acheson whose activities were one of the early targets of the work of Joe McCarthy. While the battle which did not end with the death of Joe McCarthy wages on, citizens can cleanse that stain by displaying the flag on the second of May in honor of one real American who literally gave his life in support of all it stood for.

Recommended reading:

"The Fight for America" Joe McCarthy, Devin Adair, 1952

"America's Retreat from Victory" Joseph McCarthy, Devin Adair, 1951

It is an American tragedy that patriots who can see that McCarthy was not what he was painted to be by the media, are blind about the power of the press in other matters.

The power of the Press had been incrementally purloined since early in this century, but it was only after world war 2 that the educationists succeeded in capturing enough territory in the schools to begin general redirection of the thinking of Americans through the minds of children. It is difficult to determine the beginning of activation of Goal No. 7 in Eisenhower's program for transforming America's future (see Chapter 29), but there is no problem in documenting that it is now de facto. Combined, these circumstances have the capability of determining the course of the future through control of individual decision-making.

Upton Sinclair may be forgiven some of his sins in consideration of his contribution to understanding the Elitist takeover of the sources which supply most of this country's "news". Forgiveness for those who participated in robbing America's children of their birthright would be harder to muster.

Prior to midcentury, emphasis in the schools generally had remained much the same as it always had been - factual material, objectively presented, and individual responsibility and initiative - as a foundation for responsible citizenship. "Progressive education" had had its foot in the school door since early in this century, but it was the disruption caused by world war 2, which made possible full implementation of mind conditioning of future citizens as they went through the reoriented schools, so they would become good members of 'the group', and 'follow the leader', instead of striking out on their own, with the competence to handle wisely the liberty guaranteed them by the Constitution.

It was about that same time that American heroes began to be defiled, and 'leaders' offered as substitutes. Just when that campaign began, along came Joe McCarthy, with all the attributes of a real American hero.

Destruction of an incipient hero was an essential part of the assault on Joe McCarthy.

The buildup began for charismatic 'leaders'. Dwight David Eisenhower, Adlai Stevenson, John Kennedy, and numerous other, lesser, acceptable 'leaders' were given the 'red carpet' treatment by the Press. Charles Lindbergh, Douglas MacArthur, Joe McCarthy, and dozens of true heroes received the blackball.

This 'buildup' is a continuing strategy, exemplified today in the persons of Mikhail Gorbachev and Nelson Mandela. Attempts to "create" heroes, were to fill the void left by the downgrading of the real thing. The 100th anniversary of the birth of Herbert Clark Hoover sparked one such movement.

While it may be true that the nature of man insistently urges recognition of figures "larger than life" as examples of conduct above and beyond the petty challenges of the workaday world, heroes of the past earned their place in history through some great deed, or a lifetime of dedication. It wasn't even 'thinkable' to "build an image", as is now being done.

As with Richard Nixon, Herbert Hoover has been the subject of dastardly, non-relevant attacks, which are regrettable. As with Nixon, the attacks against Hoover did not aim at substantial targets, but were personal abuse, and unwarranted.

Like Nixon, Hoover gave lip service to the principles which are best described as "Americanism", but which only served to shield from view acts which served another cause. While both these men gave it their best shot,



that strategy came to its ultimate potential in the person of Ronald Wilson Reagan.

In accepting hero-figures, Constitutionalists must determine that the object of their admiration carries the same torch which lights THEIR path. DEEDS, not WORDS are the guarantee of that.

Some time ago, I attempted to demonstrate the steps taken through the years which have brought these United States to their present precarious position. In my research for that, I found little known facts about Hoover's part in the destruction of basic American concepts already on the record.

My study\* pointed out that President Truman had chosen Hoover to head his Commission on Reorganization of the Federal Executive, on the basis of what had been done during the Hoover administration along those lines. It was Hoover, not FDR, who first utilized the concept of commissions, not only to study issues, but to SET POLICY. FDR actually scored Hoover for this radical departure from traditional governmental procedures, in kicking off his campaign against Hoover.

This transfer of functions from elected representatives to appointed officials was done so skillfully, that most citizens today are probably still unaware that it occurred. I know I was shocked when I first learned of it.

In addition to instituting the beginning of "managerial" or "administrative" governance, Herbert Hoover initiated a technique of executive action, which is at the heart of many of our problems today. It may well have done more to destroy citizen control of the government than any other single act of any single person. As an example:

When the citizens of California took the question of the legality of the Planning, Programming and Budgeting System (PPBS) to the State Attorney General, the opinion from that Office stated that "in the absence of denial by the Legislature, the PPBS is being legally implemented".

What did that opinion have to do with Herbert Clark Hoover? Simply this: It was Hoover who conceived the plan which has been described as "putting inertia and indecision on the side of change". When the Congress, on 30 June, 1932, passed the Legislative Appropriations Act of that year, probably few Members were aware of the significance of a section of that Act (if they even knew it was there!), which gave a new and dangerous power to the President.

That section permitted the Executive to INITIATE legislation - a Constitutional and historic duty of the LEGISLATIVE branch. It allowed the President to propose government action, which, entered in the Federal Register, if not VETOED by the Congress in a stipulated time, assumed the force of law. THIS was the beginning of the non-laws now known as "Executive Orders", and it originated with Herbert Hoover. AND it was the basis for the California Attorney General's opinion on the PPBS.

While Executive Orders have existed since the Constitution became the law of the land, never, before Herbert Hoover, were they any more than 'housekeeping' directives.

This single act should preclude forever any acceptance of Herbert Hoover as an American "hero".

The Courts have accepted this aberration as legitimate, even though it flies in the face of Article 1, Section I, of the Federal Constitution, and makes a shambles of our historic system of representation. It is NOT "pursuant" to the Constitution, and its legal standing is questionable.

It should also be noted that it was the "Hoover Commissions", appointed by both Truman (D) and Eisenhower (R), which recommended the "budgeting and accounting system" sometimes known as PPBS.

If the legal government of this country is restored, some of the heroes for tomorrow's generations of Americans will certainly be found among the

elected officials who courageously lead the way to dismantling this unAmerican System, not among the ranks of its progenitors.

ADDENDA:

\* "So Desperate a Step", K. M. Heaton 1967. (Available in ACIR Report A-43a, 1974.

## THE MYTHS OF COMMUNISM - 19 - Soviet Technical Superiority

There was a time when the motley crew in the Kremlin was recognized (by most people) as the gang of criminals they are - moral and ethical bankrupts - terrorists - capable of any bestiality in pursuit of power. How was it that such creatures became 'respectable', to be accepted as 'legitimate' leaders of a large part of the world (no matter the illegitimacy of the means used to extend the iron curtain), and feared for the potential contained in a war machine claimed to surpass that of the rest of the world?

There are those still living who can remember the betrayal of Poland; the rape of Austria and Hungary; the freedom fighters in Hungary who were promised help from the U.S., and didn't receive it; the domino falling of Eastern Europe; the creation of the 'iron curtain'; the celebrations here of the officially declared "Captive Nations Week"; and the protests over the first "cultural exchanges". The arrival of the Bolshoi Ballet during the Kennedy years was a cue for Americans of every ethnic derivation to stage protest demonstrations outside the theaters where the Ballet appeared, all across the country. Other "Americans", however, filled every seat inside, pushing past the protestors, casting disdainful glances at them, and tossing to the floor, unread, the flyers exposing the perfidy involved.

How could the Ballet, relic of a great country, be accepted as representative of so foul a dictatorship as that in the Kremlin?

That was a time when the United States had a war machine which, without question, surpassed that of the rest of the world combined. The Ballet was a key element in reversing the American dominance in world affairs, just as "pingpong" diplomacy opened the door to acceptance of communist China as a legitimate factor in the world community.

These matters MUST be considered, as the Carnegie-funded, administration-approved 'cultural' exchange of teachers, students and education is escalated; as USTEC (United States Trade and Economic Council) increases its efforts to interface Soviet/American business interests; and as the official Washington/Moscow axis continues to discuss SALT (Strategic Arms Limitation Talks), even while a "kinder, gentler" occupant of the White House proclaims acceptance of Soviet moves into 'democracy'.

The record shows that the succession of Soviet 'leaders' since Lenin has been markedly deficient in any of the attributes essential to effective conduct of even the most mundane matters involved in government. In the main, they have been recruited from an illiterate peasantry. None have been "intellectuals"; few have had a background preparatory to guiding even a local soviet, let alone the course of a nation - much less to make decisions binding on the world.

Certainly, there is nothing in the record to suggest that any of the Soviet brass possessed the competence necessary to mount a worldwide assault of the nature and scope which has occupied the Kremlin throughout its history.

The record DOES show that Soviet technical superiority is a myth - created in America, and dependent on transfer of American expertise, materiel, money and technology to the Soviet Union. The record also clearly manifests existence of a capability for refined techniques of strategy and tactics unmatched in history.

If the power which exists in the Kremlin is not native in origin, what, then, IS its source?

The incongruity of official policy of the United States, visavis the series of scofflaw brigands in the Kremlin, has been a continuing source of bewilderment to thoughtful people everywhere. Unjustifiable support by American administrations for, and collaboration with, criminal scum with an unbroken record of catalogued atrocities, and a self-proclaimed mission to "bury" us, is unprecedented in history. An unceasing barrage of disinformation emanating from administrative offices in this country, transparently designed to rationalize such an indefensible posture, has restrained opposition, but fails to explain such policy. There is no solid foundation for belief that that the Soviet goal has changed.

There is strong evidence to suggest that another strategy to achieve that goal has been initiated.

It is an established fact that Lenin and company were financed by a cabal of wealth headquartered in New York and London. Aided by the cabal, those soviet radicals obtained entry into Russia, penetrated the "people's revolt", and subverted that revolt to another cause. That 'cause' used the name of 'communism', but not its substance. Again, a variety of apologia tried to bridge the gap of credibility between what was, and what was acclaimed.

Before another SALT round is ratified, that credibility gap must be spanned. Past experience demonstrates that such agreements only further jeopardize the capability of the United States to protect the national interest, and do not reduce Soviet capability or purpose. Logic suggests that the cause of repeated 'failure' must be examined, past errors of judgement corrected, and more promising alternatives found.

Such an examination might disclose that the participants in these rounds do not share the same expectations for the outcome. OR, they might share the same expectation, and it not be the one publicly stated. It could even be that a hidden agenda credits SALT failure as "success".

To clarify, consider:

Knowledgeable Americans are familiar with the presence in every administration here, of an "invisible government", which directs policy - foreign and domestic - to serve an international purpose. Assume, for discussion, that the present entities in that 'invisible' group are the heirs and assigns of the cabal which financed Lenin, and that they have a Goal which is compatible with the Soviet goal, toward which their efforts are directed. Assume that that Goal is the establishment of an elite superstructure above all existing governments, through which control of all the resources of the world will be theirs.

Suppose this cabal viewed events in Russia as an opportunity, and Lenin as an agent, to secure that opportunity for them. An agrarian society, made rudderless by the coups, and leaderless by assassination and/or exile, could be an invaluable acquisition to further their Goal.

A pseudo-government, acting under control, could conduct experiments not possible otherwise. Strategies, tactics, and techniques could be initiated and tested, without constraints. Especially, if the whole territory was isolated from the rest of the world, so no knowledge of what was being done could leak out.

Such a 'government' could begin assimilation of contiguous countries, and be camouflage for the penetration of others. It could claim invincibility, for none could prove otherwise. It could develop ways and means to control its people without having to answer to world opinion. It could be a center for training nationals from other countries in strategies of subversion, which they could use on their return to their countries of origin. It could send agents provocateur to other areas to begin development of the machinery for control which had been proven effective in

internal pilot programs.

Of strategic importance, such a 'government' could create the illusion of invincibility, since, because of strict limitations on access to its secrets, none could refute the claim that it was or prove that it was not. It then could provide the impetus to induce free people to 'voluntarily' unite in a "one-world government" under the threat of annihilation. What stronger stimulus could there be to that end, than the "either/or" choice between an end to nationhood, versus an end to existence?

Faced with the ultimatum inherent in the threat of a purported Soviet nuclear capability, the world has been brought to the moment of truth. Will SALT be the catalyst to bring about "coexistence"?

Or is it possible that "friendly coexistence" will bring fruition to a mutually acceptable "peaceful world", with a war against pollution replacing the "perpetual war" among peoples?

Or will the American people demand that the administration now in Washington recognize that "Soviet nuclear capability" was manufactured in the United States? Can this administration be moved to formulate a policy which recognizes that 90 to 95 percent of Soviet technology has been transferred - directly or indirectly - from this country and/or its allies? Can this administration be moved to understand that a "democratic world" of peace is an impossible dream, and that the peoples of the world will never accept the force which will be required to provide their Goal?

If not THIS administration, can the people elect enough true American representatives to require that commitment from the NEXT? Is it yet possible for Americans to force those who hold the public trust to begin a real liberation of the captive nations - including their own - and start the return to "the separate and equal station to which the laws of nature and of nature's God entitle them..."?

Recommended reading:

The "Wall Street" series on Soviet/American relations by  
Antony Sutton - Stanford University Press

Richard Landkamer, Unpublished Reports on USTEC,  
1987-8-9-90.

"Report from Iron Mountain" - "John Doe", Dell Publications 1967

## THE MYTHS OF COMMUNISM - 19 - Tiananmen Incident

It is almost forty years since Herb Philbrick ("I Led Three Lives") and Edward Hunter ("Brainwashing in Red China") brought to public attention the existence of a frightening capability of mind control. During those years, an accelerating intelligence of just how much a threat that capability is to the civilization the world has known, has failed to create any organized opposition to use of such control.

None of the reports out of China about the tragedy which occurred in Tiananmen Square have included recognition of the fact that the powers that be have used cybernetics to control that benighted country ever since Hunter first exposed its use to transfer China to red rule.

The fact is that those "students" have been manipulated since before they were born. If that does not make sense, it is because, despite the evidence, people do not recognize state control of population as an element of systems decision-making.

Those "students" have been conditioned all their lives to do the bidding of their puppetmasters. Their "revolt" could not have "happened", unless the powers that be (for their own purposes) decided it was needed. One can only extrapolate scenarios to suggest what the purposes could be.

One such scenario could indicate a dissident element in the power structure aiming to establish a New International Economic Order. Another could be creation of a climate for change to expedite that NIEO. Others can be constructed. While this is important, it pales in significance when juxtaposed against the fact that there has been no public recognition of the use of systematic control as the causative factor underlying what "happened" in Tiananmen Square.

There will never be an effective resistance to the world revolution now speeding toward finalization, unless systematic capability is factored in to any effort to counter it.

THE MYTHS OF COMMUNISM - 21 - In the Name of "Democracy"

"As regards the national question, the proletariat must, first of all, insist on the promulgation and immediate realization of full freedom and separation from Russia of all nations and peoples ... who were forcibly included or forcibly retained within the boundaries of the state...i.e. annexed..."(1)

"The social revolution cannot come about except in the form of an epoch of proletarian civil war against the bourgeoisie in the advanced countries, combined with a WHOLE SERIES of democratic and revolutionary movements, including movements for national liberation, in the undeveloped, backward and oppressed nations..."(2)

"Just as mankind can achieve the abolition of classes by passing through the dictatorship of the proletariat, so mankind can achieve the INEVITABLE MERGING OF NATIONS only by passing through the transition period of complete liberation of all oppressed nations..."(3)

V. I. Lenin

About thirtyfive years ago an expert on communist strategy and tactics wrote a book titled "You Can Trust the Communists"\*, in which the author attempted to demonstrate that 'communists' had been very open in informing the world exactly what their goals and objectives were. The problem was that no one in authority in the so-called "free world" seemed to believe anything the 'communists' had written or said in their instructions to their co-conspirators - the 'communists' were only believed when they were face to face with those they were intent on deceiving.

As the world is witnessing the present day actuality of the "promulgation and realization of full freedom and separation from Russia"(1) of the captive nations, it would be the better part of wisdom to view what is happening under the banner of 'democracy' in the light of the stated plan, planned strategy, and carefully developed tactics, which have made these incidents possible.

We ignore at our peril that the events being witnessed in the satellite countries are part of the machiavellian plan laid out so long ago. When Lenin, Stalin and Company gave instructions on the various components of the world revolution, they were speaking to, and for the benefit of, those who were to carry out their schemes. It could be fatal not to recognize that they would not lie to their subordinates on such serious matters.

It is also perilous not to recognize that the massive movements being "promulgated" today cannot possibly be a voluntary rebellion against 'communism' as they are represented to be. The most obvious evidence that this is so lies in the existing power to destroy which the Soviet hierarchy still possesses, and which it uses when Soviet purpose is served in so doing. If the power behind the 'communist' movement were opposed to the "whole series of democratic and revolutionary movements"(2), it could put an end to them summarily. The record shows that what is occurring is part of the Plan devised so many years ago.

More evidence exists in the mass use by the throngs of "dissidents" of the 'communist' "salute" - the clenched fist. This is a recurrent signal

# section III

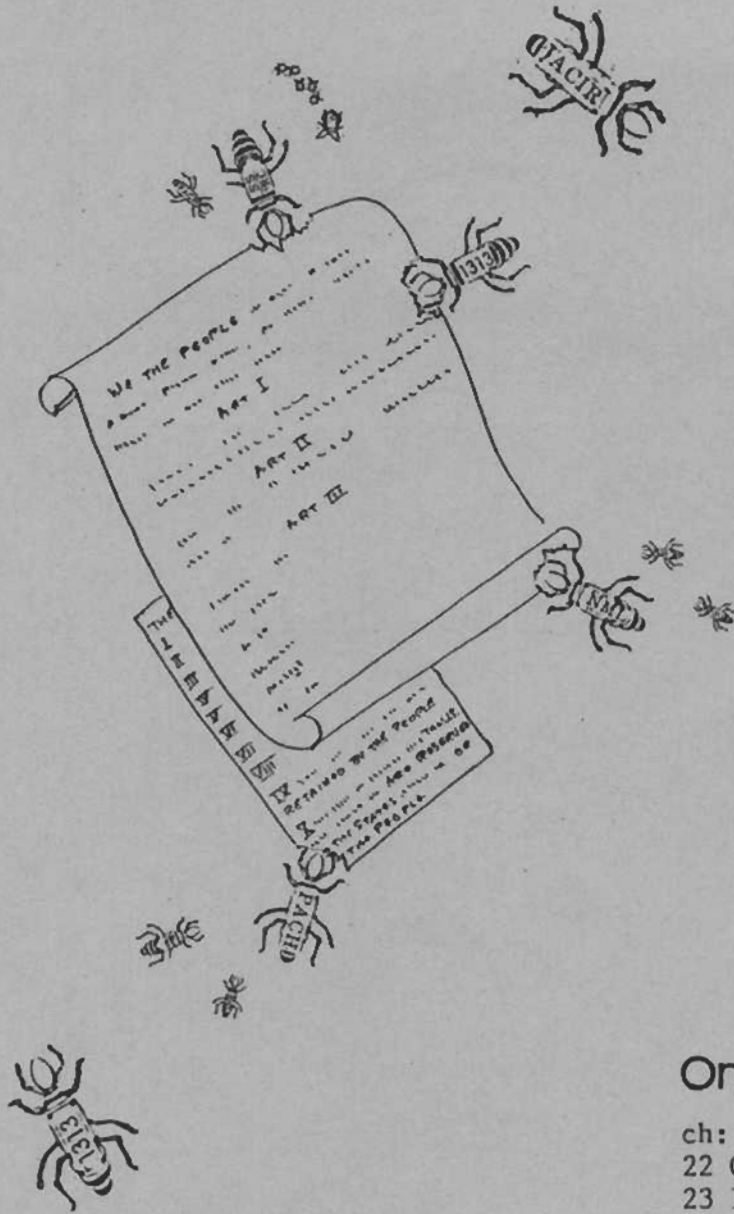

## On the Road to Revolution

ch:	pa:
22 Get First Understanding	III - 1
23 I'd Rather be Right	III - 4
24 All the World a Stage	III - 6
25 A Conspiracy of Silence	III - 9
26 The Politics of Change	III - 11
27 The Wretched Refuse	III - 14
28 The Panama Affair	III - 17
29 "Goals for Americans"	III - 21
30 The Supreme Court as an Agent of Change	III - 26
31 Time Bombs	III - 28
32 Post-Constitutional America	III - 31
33 Fifth Estate - or Fifth Column?	III - 34
34 CONTRAtemp in the NSC	III - 36
35 Twistory of History	III - 39
36 Keep Chipping Away	III - 41



"Take no man's word against evidence, nor implicitly adopt the sentiments of others who may be deceived themselves, or may be interested in deceiving us..."

-John Adams  
Boston Gazette, 1763

The materiel presented in this tome is only a fraction of the information needed to begin to meet the herculean challenges confronting any who would immobilize the forces behind the destruction of civilization as the world has known it. What is offered here is intended to provide a starting point for a more productive opposition to the revolution.

While we can offer our evaluation of the situation, and present some of the steps we believe must be taken, only you, fellow American, can be the arbiter and the catalyst for any counter offensive.

In any case, the first step toward any such objective must be recognition of the true nature of the struggle which has convulsed the world at an accelerating pace this past hundred years.

A major error promoted by the protagonists of the revolution is the nature of the battle. It is not against 'communism', nor 'socialism', nor any of the several concepts which have engrossed the public in the past. This battle is against a machiavellian scheme to usurp dominion - to alter the very essence of the lives of all mankind. It is, in fact, a battle for the minds of men. Omitting that fact from any strategy created to meet the challenge dooms any hope of realization of success against the forces now engaged in sweeping every vestige of self-determination off the face of the earth.

The first order of business must be recognition of the almost unrestrained penetration of established concept. While the problems loom large on a worldwide front, recognition of the source of those penetrations will inevitably trace back to manipulation which has disrupted neighborhoods everywhere, so the next step is for each individual to examine the evidences of that penetration in his own community, become familiar with the programs being implemented, and then, begin to spread his understanding.

So long as there is acceptance of any premise that the road ahead leads to any form of political organization other than serfdom, there is minimal possibility of rousing sufficient resistance to the scheme for transferring dominion to this self-appointed cabal now rushing toward their goal.

The world as painted by George Orwell in his definitive book "1984" is the world as it will be. The form of that world is already taking shape, as the examples cited here truly show. We ignore at our peril the warning Orwell gave.

Control must be wrested from the existing power structure, and the eradication of that control must begin in the mind of every human being who treasures individual liberty. Recognition that these megalomaniacs do have a weapon more powerful than any conventional arsenals provide is of the essence.

Defusing that weapon has to begin with each individual. Once personal recognition of the altered concept which permits use of that weapon is achieved, the next step must be to spread that recognition to every person

in one's orbit who shares the basic human urge for self-determination.

In the United States, the goal must be to return to the political system provided in the Constitution. That will not be easy, but it can be done if there is enough resistance to hold the aggressors at the present line of battle while it is being accomplished. Until that objective can be achieved, it is vital that every American\* now in office who can be reached is made aware of his responsibility to preserve and defend the elements of that political system.

A basic requirement is rethinking, individually, one's political responsibility. In the United States, every citizen, native or voluntary, is a political being, simply by virtue of that citizenship. When politics are left to politicians, the silver cord tying the citizen to his birthright is severed. When the best possible candidates for representation reject public service - for whatever reason - the void can be (and usually is) filled with people with a vested interest not necessarily supportive of the government provided in the Constitution - nor of the interests of his fellow citizens.

That there is still room for moving incumbents was proven in the matter of increasing the salaries of Congress. Even those Americans who do not yet know the longrange goal of the revolutionaries can be enlisted to oppose such a cynical move. The idiocy of claiming, after having spent billions of dollars to win seats on the Washington merry-go-round, that the victors could not afford to sit there, roused a hornet's nest which could not be denied.

Many of these are the same "legislators" who voted to confiscate seniors' COLAs (cost of living allowances) to pay for the increased costs of their medical needs. Is there no shame among the perpetrators of this fraud? It would not be too hard to find out, if the victims of the Medicare scam imitated the strategy used to stop the pay raise. But once more, the determination to achieve establishment objectives permitted the raise anyway. It was brought to the floor again, and passed sans hearings, sans objection, sans any visible concern that the public will make them accountable when they come up for election again.

This situation goes to the heart of the political system of this country. Under the Constitution, Congress is elected to represent the national interests of the people in their districts. By becoming residents of the Washington area, those people we 'elect' move their interest from the local district to the domain of the revolutionaries. They become visitors in their districts, with little time or opportunity to keep abreast of the wishes of the people who elected them. They become, instead, minions of the clique now directing their activity. To some degree, this is also true of those sent to State capitols.

In far too many cases, the people who seek office are financed by outside interests, because they do not receive campaign funds from, nor enjoy the confidence of, those who will be voting. This is how the situation, constantly decried, develops where the choice of candidates is "the lesser of two evils".

Pressures from these outside sources have a telling effect on those elected at the local level. Unless those who offer for office do so with the support of those they should represent, the result is predictable.

At some point in time, there must begin a rollback of the time elected officials spend away from the grassroots. Until that time comes, how much better it would be to require legislators to maintain their families among their own people, even if it means separation from them for periods of

time.

The money requested to "maintain homes" in Washington could better be applied to providing travel back to their districts. This would give Members of Congress as much time with their families as many traveling salesmen, for instance, have; encourage contact with their constituents; and discourage continuing the long sessions of Congress which presently provide the opportunity for extending the revolution through manipulation of the decision-making process by the revolutionaries, who presently have more access to elected officials than those they are claiming to represent.

This concept also applies to those elected to State office.

The next step is to encourage those local officials who are receptive to the pleas of those who elected them, to cut off support from the revolutionary agents of change who presently are receiving public monies to continue their revolutionary activity. This means the dues paid to any and every 1313 body, as well as removing the opportunity given to 1313 to brainwash local officials who now attend their schools for subversion called "meetings" to discuss 'local problems'. How much better their time would be spent, discussing local problems with those burdened by the problems!

While this is being done, citizens should be making plans to obtain the consent of the best men and women in their communities to run for office in the next election. It cannot be stressed strongly enough that the greatest public service American citizens can perform is to represent their fellow citizens. Serving in appointed positions for whatever purpose does not compare with being the official voice of the community.

When this is done, two years is all it will take to begin destruction of the revolutionary replacements for our federal structure, and to immobilize the machinery of foreign policy while it is being reconstructed to fortify the interests of the United States.

Simplistic? Yes. But complex problems do not necessarily require complex solutions.

Unless such simple steps as these are taken, there is no way the revolutionary assault can be met with any realistic hope of reversing its progress.

Addenda:

"Americans" - citizens of the United States of America who hold the Constitution to be the arbiter of all political action in this country, as opposed to "internationalists", citizens who want the Constitution revised to provide entry into a World Government.

For additional information on 1313 see Section V - "Conquest by Consent"

Americans are reeling from the barrage of words which daily assault them on every front. An ever-mounting war against tradition is taking its toll, as chaos follows confusion in the wake of erroneous information and altered concepts which assume the mantle of truth by steady repetition. In the confusion, even those who do know better find themselves accepting strange "democratic" forms of government function.

'Democracy' is served by opinion polls, citizens committees and commissions, protest and support activities, and a host of other techniques. All are destructive of representation.

Opinion polls are the current promotion, just as hoola hoops once swept the country. Polls make about as much sense as tools for determining the direction a nation shall take as the hoops would have.

What shall be done about nuclear power? Ask the Man in the Street. He has received his vast knowledge of the subject from some half vast radical, who has been lionized into a national figure by the kept news media, so, of course HE is an 'expert'. Substitute for nuclear power any complicated problem of today, and the answer is the same. Ask the Man in the Street.

Legislative polls are a spinoff, and an important one, of the opinion gathering strategy. It is a rare congressperson or senator who doesn't demonstrate his deep-seated desire to "represent" his constituency by a more-or-less regular questionnaire. No matter that the questions are mass-produced, many equivocal, most designed to elicit a predetermined response. None address the truly vital issues involved in our daily lives.

No matter that facts about the subject under scrutiny are not included. Thousands of dedicated Americans dutifully ponder the weighty matters for which their reaction is solicited, and, with a righteous conviction that they are performing a civic responsibility, they fill the little boxes with appropriate X's, and fire their opinion off to the source of the quiz.

Little they know of the rapacious computers, scientifically programmed to accept these freely given responses, to use for other than the stated purposes.

As a case in point of the willingness of the American people to accept the legitimacy of "polls", this: A recent public opinion poll purported to show that fully 45% of those polled considered themselves to be "right of center", politically. Of this 45%, 16% claimed to be "substantially right", and 8% allowed that they were "far right".

The poll did not tell them where "center" was, and it did not try to determine whether or not that was known. But, of course, everyone knows what "right" is, right? Well, no. Everyone does not, because many have accepted the propagandized concept of "right", and the equated "conservative".

It would be more to the point to begin such a poll by asking Americans where "center" was. Having done that, the result of the poll, which concluded that this country is experiencing a "shift to the right" would have some validity, and the efforts of the Daily Brainwash could be neutralized to some extent, as the politicians shifted into high gear for the quadrennial personality contest to select Mr. America.

Was that "shift to the right" from the left toward the center? Or from the center toward the right? The answer to this is vital to the 47% mentioned in the poll, to the 16%, and the 8%, but equally to the other 53%. And the great globe, itself.

Because, my friends and foes, if the center is the limited government supplied by the Constitution of these United States, and that shift is from the left toward that center, then it is right. But if it is from the center to the right, that's wrong.

Because "far left" is totalitarian dictatorship, toward which the self-proclaimed enemies of our legitimate government have been steering this Ship of State for these many years, and the "far right" is anarchy. Moving from the forced march into a proposed totally managed and controlled society, toward the sanity of balanced powers carefully maintained, is a rational direction to take. Moving away from that legitimate center is less than sane. It is more like treason.

Wouldn't YOU rather be right on center?

Those who read only general circulation outlets cannot know the specifics of the worldwide revolution. The "mass media" makes no attempt to provide either in-depth or sequential reports on events which are transforming the United States of America from a Constitutional Republic into an administrative dictatorship, let alone those events affecting other countries.

One would never know, from news reports, that those events are preparing the amalgamation of a world conglomerate of equalized states - once sovereign nations - melded into a single, manageable unit.

This is revolution, on a scale never even envisaged before now.

Had it not been for the few remaining independent local papers; even fewer specialty weekly or monthly outlets, created to fill the gap left by the demise of nonconforming major news sources; a dwindling number of radio and TV programs dedicated to hard news; and a smattering of pamphleteers, carrying on in the tradition of Thomas Paine, the revolution would have been over long since, and the world would never have known what happened. As it is, a handful of hardy souls, undaunted by the odds, have kept the spotlight turned on characters and activity behind the charade holding center stage, and the drama is not yet over.

Adult Americans, whose only background in politico/socio/economic matters has been supplied by the public schools and the mass media during the past fifty years have a distinct disadvantage in seeking answers, for they have been denied vital information, and given distorted versions of much of history.

To an uninformed public, baffled by events which make no sense, a seeming continuity exists, but a shadow of unreality hangs over the socio/political scene. That shadow is evidenced in problems never solved; in 'solutions' which create more problems; in a perceived deterioration of all the proven values, methods and institutions.

Representative government appears to be functioning, but, behind the scenes, a "scientific bureaucracy" has been created: "a disciplined organization of officials ... appointed by representative bodies of diminishing importance, and coming at last to be the working control" (of the State).\*

Examples of the "working control" abound in the reports of those limited circulation papers just mentioned. The links between local moves, and state action; between both or either of these and the federal initiatives, are exposed and explained there - but not in the 'mass media'. Knowledge of this information about the collaboration between government departments is vital, in any attempt to defuse this revolution.

Occasionally, the "disciplined organization of officials"\* moves in ways that defy detection, even by the most watchful monitors. It was so, when the control system, designed to manage and institutionalize the programs of the 'scientific bureaucracy', was written into the script.

Initiated in the late sixties by agents of the Rockefeller-created "1313" conglomerate (of which, more later), a program to suborn the sovereign States of Wisconsin, Vermont, New York, Michigan and California into acting as standins for the other 45 States, while strategies, tactics and techniques were perfected to penetrate the rest, was incubated at George Washington University, under a blanket of secrecy. This was the

infamous "5-5-5 Project". Subtitled "Implementing PPB in Five States, Five Cities and Five Counties", the Project was not done under legislative approval.

Legislators were not told (in California, at least) that their State, by Executive fiat, was acting as a "pilot project" in an unprecedented, untried experiment. They were manipulated into approving a "management system", by passing seemingly innocuous bills, purportedly mandating a new method of "budgeting and accounting", which were, in fact, mandating The Planning, Programming and Budgeting System (PPBS). The PPBS is the revolutionary strategy to assure management and control of the worldwide hegemony.

What is clear now, but wasn't then, is that this "project" was staged like one of Hollywood's spectacles. The legislators were handed the script, and read their parts, as directed. If any of them recognized their new role as subordinates to the "disciplined organization of officials", none rose to protest - and, in California, only one dissenting legislative voice was ever heard beyond the confines of the State Capitol.

And the mass media made no waves about this perversion of their vaunted "democratic process".

At the local level in California, trained change agents were already jumping the gun, preparing local districts for the new age when they would be the battle line troops, handling the transition into systematic control.

The script called for "data processing", to provide "fiscal accountability" for the State, and an "advisory commission", to formulate a "budgeting and accounting system" for the schools. The legislators in California, for example, with only one dissent, obediently passed their responsibility to protect the integrity of the State into the waiting hands of the "scientific bureaucracy". In the bill which required the State to install "data processing", there was also a mandate for the PPB System. In like manner, the bill creating the Advisory Commission for education also carried that mandate.

These two bills emanated from the Executive Office - then occupied by Ronald Wilson Reagan - with a mandatory "do pass". And pass they did - in a record three weeks time.

In the bill for the State government in California, the legislature delegated all authority to develop The System to the eager standins, waiting in the wings. In the School bill, they extended the "scientific bureaucracy" beyond the government, and into unidentified private hands, by giving the Commission authority to hire unspecified "consultants" to do the work.

Had they played the part for which they were hired, the legislators would have conducted the hearings the Commission held in their stead, and this play would never have been staged, for then the legislators would have known what was planned, and surely wouldn't have approved it. As it was, they delegated their lawful roles to appointed substitutes, and illegally gave THEM authority to hire an external agency which just happened to have a vested interest in The System!

Marilyn Ferguson, in her "Aquarian Conspiracy" identified the Chairman of the California Assembly Education Committee, John Vasconcellos (who played a leading role in implementing the PPB program for the schools), as a New Age collaborator.

To bring an end to this tragic farce, the curtains must be opened wide, the proscenium bared, and the entire strategy exposed for what it is - a carefully stage-managed production.

To accomplish this, a number of things must be done, with all possible speed.

First, and most important, is for all resistors to be sure that they know and understand the strategies being used by the manipulators of the "scientific bureaucracy". This book is intended to be a refresher course for those who already understand strategies and tactics; a primer for those who don't. Hopefully, this will encourage examination of ways and means to make those strategies work for the resistance.

ADDENDUM:

'solutions' = hegelian strategy: determine a goal;  
create a problem; offer the new goal as a 'solution'.

RECOMMENDED READING:

\*"New Worlds for Old" - H. G. Wells, MacMillan, 1908  
"Experiment in Autobiography" - ibid, 1925  
"Implementing PPB in State, City, County - A Report on  
the 5-5-5 Project" - George Washington University, State,  
Local Finance Project, 1969.  
"The Brass Check" - Upton Sinclair, self-pub. 1917  
"Prejudice and the Press" - Frank Hughes, Devin Adair  
1950



Gradually, with a general awakening of the American people, a corner of the blanket of conspiracy which has hidden the hands responsible for the redirection of world affairs for almost a century, is being lifted.

The evidence of a seditious conspiracy has been at issue for almost that long, as, from time to time, one or another of its manifestations have caused a ripple of alarm.

The Establishment image of Franklin Roosevelt was so effective it precluded acceptance of the validity of charges made against him throughout his several administrations - including the most serious one, that he planned to involve this country in world war 2, and, in fact did so.

The same was true of Woodrow Wilson, and the first "world war". Strong evidence that both these wars were arranged to further the design of an integrated "world order", planned by a group of identifiable conspirators, has never been satisfactorily researched, examined, reported, and dealt with.

Determined Americans, at great personal risk, have consistently, over the years, decried the manifestation of a clear and present danger to their lawful government and their individual liberties.

The Press, with a single voice, leads the pack baying at the heels of those so brash as to attempt to resist the conspirators' Plans. "Obstructionist" and "extremist" are some of the milder epithets applied to patriots who fight back.

As the conspiracy has flourished and borne fruit, it has been ever more difficult for its promoters to deny its existence. Evidence continues to multiply which supports the theory that "the communist threat" is, in fact, another fabrication of the Establishment schemers. Certainly, "communism" has served their cause well, in many ways.

The overthrow of the Russian government in 1917 provided one country after another in which to initiate pilot programs to test theories of control. "Communism" became an excuse for extended and escalating distribution of America's bounty all over the world. In this country, "communism" produced scapegoats on whom to place the blame for the treasonous moves necessary to take control here.

The incredible situation visavis the execution for subversion of the Rosenbergs, viewed against the witness of George Racey Jordan to the actions of the government the Rosenbergs "betrayed", gives a horrendous perspective of the conspiracy. On the one hand, the Rosenbergs sent military information to the Soviet "enemy"; on the other, Jordan testified that the government which found them guilty was sending military information and materiel (including that needed to make use of the information sent by the Rosenbergs), to the same "enemy" - on government planes, at public expense!

Equally incredible, and even more hideous, is the record of the Vietnam obscenity in which America's sons, husbands, and fathers were slaughtered and maimed by the hundreds of thousands, while the government, which sent them to that bloodbath, supplied them with faulty materiel, denied them the goal of victory, and sent weapons, tools, food and technology through the Soviet aparat to the "enemy" they fought.

With the capability for such crimes against a just government and mankind, itself, can it be successfully argued that the present incumbent of the United States Presidency could not place ambition above the

interests of those he is supposed to serve? Is it safe to assume that THIS (or any future) incumbent is incapable of such treachery? Or that conspirators would not use such a gut issue as that, to further their goal?

The only possible protection for Americans now, is to reject the conspirators strategy, and repudiate ANY who aspire to the Executive Office in either of the major Parties. Concentration on taking back the seats in government over which citizens can exercise control is the only route to frustrating the conspirators' Plans.

By denying support to aspirants to the Executive Office, and presenting a massive response to Constitutional representatives, Americans can best demonstrate their determination to support and defend their lawful government.

Recommended Reading:

"From Major Jordan's Diaries" George Racey Jordan, USA 'ret.  
Bookmailer, 1959

In any production, behind the actors seen on stage, there is a crew of 'hands' - the "advance man", in charge of propaganda, promotion and related matters; the producers; script writers; set designers; scenery handlers; costumers; stagehands; electricians; "props"; and the ubiquitous "backers" or "angels" - the money people.

In the real life drama on the world stage today, parallel positions are known as publicists; consultants; planners; aides; directors; facilitators; change agents, and generally, "experts". And, of course, the ubiquitous financiers - who may or may not be YOU.

Sometimes, the curtains part enough to allow a fleeting glimpse of the 'hidden hands' behind the scenes which prepare the production for public viewing. When this 'happens', well-trained stagehands quickly close the curtain, and any watchers who note the action and attempt to describe it are given to understand that they didn't see it, because there was nothing to see. In the real world, this is known as a "coverup".

Such was the nature of the exposure of the Planning, Programming and Budgeting System. Its existence was denied, its name was changed, its capability was disguised, and the rest was silence.

Such, too, was the policy paper known as The Politics of Change (TPOC).

One of the tactics of the revolutionaries is to respond in silence, when they receive a telling blow. It sometimes works against them, when they do that, and the matter of this document "TPOC" was one such incident.

I had been receiving the output from the California Council on Intergovernmental Relations (CCIR) for some time, when I went before the Governor's Task Force on Local Government Reform, to present testimony against CCIR and the State meddling in local government affairs. After my appearance there, the CIR reports stopped coming to my mailbox. I complained to their staff about it, but could not get them to reinstate me as a recipient. So I went to a State Senator, and told him my problem. He called the CIR office, and told them I was to be reinstated as a recipient, and that I would be over to pick up the documents I hadn't received. When I got there, I was ushered into the office of the person in charge, who apologized profusely for any inconvenience I had suffered, and told the secretary to see that I had whatever documents they had, which I had not received.

They were just moving into a big new office, and there were huge boxes of material still not put away. The girl started showing me what was there, going to each box in turn, and handing me a copy of its content. I selected those which I had not received. I noticed, though, that there was one box near her desk, which she studiously avoided. When we had finished checking the other boxes, I asked her for a copy of the minutes of the last CIR meeting, and she had to go into another room to get them. While she was gone, I idly picked up one of the documents from the box she had not looked into. It was titled "The Politics of Change in Local Government Reform" (better known now as TPOC). "Local Government Reform" was the name of the game at that time, so I added it to my stack. (I was supposed to have anything I had not received, and I sure had not received that!)

So that was one time when they would have been better off, if they had

just continued sending me the public material. For TPOC was certainly never intended to be seen by such as me. It was a textbook on mind control techniques - an appalling negation of the principle of self-government, as it told 'public servants' how to use "the politics of change" to obtain programs which the citizens did not want.

After I had studied that document which had come into my hands so fortuitously, I was at a loss as to what to do with it. The first step was suggested by the document itself, because it included three "case studies" of situations in California where use of the strategies it provided "to bring about change in local government structures" was discussed. Two of those cases were already history, but the third concerned a matter of Sacramento City and County Consolidation (C/C/C), where these techniques were then being used to create a single entity, neither city nor county, but a hash of both.

Now listen up, all you who might think I press too hard for election of representatives. It just so happened that there was one representative on the Sacramento City Council, Sandra Smoley, who had been fighting a courageous but lonely battle against consolidation. I did not know her personally, so I arranged for the TPOC document to be taken to her by a mutually trusted ally, and she blew the whistle on the 'hands' using TPOC to reconstruct her city. Thanks to Sandra Smoley, Sacramento City-County-Consolidated (C/C/C) was defeated for that time.

Suppose Sandra Smoley had not been elected to that seat on the Council. Would there have been a different result?

Let's look at another elected official, this one a 'politician', sometime mayor of Oakland, California, John C. Houlihan. As Mayor of Oakland, Houlihan gave an interview to the Oakland Tribune in 1966, in which he stated that he would be ready to step aside as Mayor, if "fullblown government reform" was implemented statewide. Such 'reform', he said, would do away with Mayors; it would also do away with "cities, counties, districts, and boards of supervisors", and he predicted that this would come to pass before the turn of the century - possibly by the 1980s.

Mr Houlihan did not have to wait for his prediction to come true to "step aside". Later in 1966 he was taken to court, for looting the estate of an elderly widow, for whom he was conservator. Staunchly maintaining his innocence, he resigned his office under fire. But when he appeared in court, he entered a surprise plea of "guilty", and was sent to prison.

Now the plot thickens. John C. Houlihan was Executive Director of The Institute for Self Government at Berkeley, in January, 1974, when TPOC was issued. On November 17, 1974, the San Diego Union reported that he had been granted a "full and unconditional pardon" by Governor Reagan for his crime. So apparently he was out on parole, at the time he participated in the production of this document which was designed to be a tool to build that governmental structure which he had predicted almost ten years before!

Houlihan is a classic example of a politician, as opposed to a representative.

The second step I took regarding TPOC was to ask for time at the next meeting of the CIR, to challenge the Members to repudiate this document, which listed the CIR as a sponsor.

While waiting to hear from CIR, I took the TPOC document to my County Supervisor, and he shared it with the El Dorado Board, with the result that they passed a Resolution condemning such practices generally, and TPOC in particular. That Resolution was sent to every person of interest involved

at the State level, every County Board of Supervisors in California, and eventually was reprinted in a number of newsletters and a few local papers and thus found national distribution. To my knowledge no other action was ever taken against the strategies recommended in TPOC.

In my testimony to CIR, I read portions of that textbook for change, such as the one which called for the use of change agents to manipulate public opinion and to "mislead, coerce and inhibit the rights of citizens" to decide what changes they want in their local government (quote from the EDCo Resolution). I asked for a response as to whether or not the Members of the CIR Board were aware that this document was put out in their name, and whether they approved of the use of such tactics. The response was - silence. Not one of the twenty or so Members spoke up.

When the next CCIR minutes arrived, they simply said that I had spoken against local government reform. I wrote and demanded a correction of the minutes from the Chair, and a minor correction was made, but no mention of the nature of the material I protested was included. I wrote again, and repeated my demand for an accurate reflection of my testimony, and received a noncommittal reply. I then wrote to my State Senator. No reply. I then wrote to the governor (Reagan), and sent him a copy of my testimony, copies of the letters mentioned above, and requested action from him. No reply. Silence.

It is of interest to note that, when a citizen wrote to the Institute in Berkeley for a copy of TPOC, the response was that that report had been 'compiled' at the request of the California Council on Criminal Justice, and was not 'published', but had been sent to the successor agency, the Office of Criminal Justice Planning (OCJP). The citizen was told it would cost \$8.00 to reproduce the manuscript and mail it.

Now, there are two interesting things about that. ONE - in the Foreword to TPOC, it states that it was compiled under a contract with the Office of Intergovernment Management, in coordination with CCIR and the Governor's Office. Make of that what you will. And then there is TWO - the box which contained the TPOC documents was in the CIR office, NOT OCJP. The container was humongous - and it was half full. Or half empty, if you like. Make of that what you will.

It is important for all citizens to know that California's TPOC is not an isolated instance. There are think tanks all over the country, applying themselves to mass behavior modification techniques such as this, and the evidence of the use of such strategies is increasing. It is simply amazing that so little notice has been taken of what these would-be manipulators are doing. Uncovering TPOC was a pure and simple happenstance. But thousands of change agents are being prepared in our institutions of higher education to continue developing this psywar technique, and that is no accident.

Why do you suppose none of those being trained to control their fellowman protest?

Why no recognition of the dangers inherent in change agency, which has become an integral part of government action, with elected officials attending seminars at public expense to learn how to get their constituents to accept programs neither wanted or needed?

Recommended Reading:

City County Consolidation John A. Rush, Self published, 1941.

Emma Lazarus was born in New York, of sephardic Jewish parents. Early in life, she fell away from the faith of her fathers, and displayed no interest in religion for the rest of her days.

When the Soviet pogroms began and found an echo in the streets of New York, Lazarus took up the Cause, and became a radical militant. She was advocating a national Jewish State in Palestine, ten years before the modern 'Zionist' movement began. It was at this time that she authored "The New Colossus", for the Cause which brought the Statue of Liberty to New York Harbor.

Save for one short passage referring to "slave trade", the United States Constitution was silent on the matter of immigration, properly leaving this issue to the Congress to work their will, as need might require. For many years, free immigration was encouraged, and the United States was the debtor to men and women of courage, who sought the rewards promised to good citizens under its government.

By mid-nineteenth century, the radical movements on the continent began to metastasize, and American liberty became a magnet for those alien ideologies. While some natives here, like Lazarus, abused their privileges, nothing could be done about that, under the First Amendment. The radical influx from abroad, however, was open to intervention, which was not long in coming.

With Lazarus' plea to "send" more of the huddled masses through the "golden door", a new dimension was needed for policy on immigration, and the quota system was devised, to limit the waves of homeless, feckless, foreigners. Health examinations were now required, and standards had to be met for entrance. A "sponsor" had to guarantee that the immigrant would not become a public charge.

From the beginning, immigration laws were a center of controversy, which mounted in intensity as the beginnings of organization for 'one peaceful world' became reality, around the turn of the 20th century.

The engagement known as "world war 1" provided the staging ground for the first massive rearrangement of the world map. Colonel House was ready with his extended group of 'social scientists', to allot territory, devise governments, and provide human resources to begin the reconstruction. Concurrently, the Establishment created ex-officio groups here and in England, to penetrate both governments, with the intent of directing "foreign policy".

The 'American' group, the Council on Foreign Relations, lost no time in beginning the work of the master puppeteers, in preparation for allotting territory, devising alternative government forms, breaking down boundaries, giving the new states new identities, dividing the spoils of the war "more equitably", and providing the human resources necessary to implement this part of the Plan.

Breakdown of national boundaries was not intended to exclude the United States. So, when the Federal Council of Churches met at their historic gathering in Ohio in 1932, to issue their Call for world government, among the ultimata the delegates were suborned into accepting was a Call for "worldwide freedom of immigration".

As Patriot Frank Kirkpatrick put it, in discussing that conclave on his radio program more than 40 years ago:

"What it means is, that there would be no limitation on who could come to America, and take over this country. In other words, the only limitation would be the number of ships available to bring the teeming hordes of other continents to this U.S.A."

The clamor to void the restrictions on immigration became even more strident, after world war 2. With Korea behind us, the Call became louder, and ever more insistent. Servicemen who had become involved with foreign nationals bedeviled their Congressmen for special dispensations.

Back in the 50s several "unthinkable" concepts emerged as peripheral adjuncts to the NIEO Plan. These concepts were so "far out" it wasn't possible to include them in logical arguments about the Plan - then.

Some of these "far out" schemes are being advanced so openly, now, that they have become routine in our daily lives. So it is with the issue of "immigration reform". That portion of the 1982 Immigration Reform Act which proposed "universal employment verification", however, was one of the unthinkable schemes which surfaced more than thirty years ago, and only now is being brought stage front and center.

A "universal identification card" (UIC), just as proposed in that Act, is a natural adjunct to the control system which is now in operation.

While the early intimation of a UIC was not connected with immigration, it is interesting to note that the pressures to "liberalize" United States policy on immigration began to mount at about the same time that controls on employment were first suggested.

In 1963, John Kennedy called for revision of the immigration laws. Upon his death, and in tribute to him, Congress responded with a spate of bills which culminated in an emasculated protection from foreign invasion through immigration. Even the inadequate controls which remained are now honored in the breach.

Under the McCarran/Walter Act of 1952, the qualitative controls of quota and national origin were extended, but not completely neutered. It took the Kennedy/Johnson/Hart/Celler bill in 1963 to do that - opening the door on the troubles which will result from this "job verification system".

There is a crying need for Congress to re-examine U.S. policy on immigration, but to tie the problems now involved in the "open border" policies (which have become a mounting threat to our national identity), to a requirement for citizens to have government authorization as a prerequisite for work or even existence, is an ominous step.

Surprisingly, it was Senator Alan Simpson, (R., Wyo.) who blew the whistle on the Public Works and Economic Development Act of 1979, yet, in 1982, was the identified 'author' and legislative whip for the Immigration Reform Act. It was a shock to learn that he intended to "plow right ahead with immigration reform", despite the "hue and cry churning up in some quarters". Since all the other provisions of the bill together, did not generate the concerns the section on universal ID did, it seems clear that "immigration reform" was not the issue. It was that element - the UIC - which was.

This element should not even be debatable, because it is not within the powers and duties of Congress, under the Constitution, to legislate on such a matter. If it were, it would still be controversial, for it impinges on the rights and privileges every American is endowed with at birth. It is the duty and the responsibility of Congress to protect the rights and privileges of native-born citizens.

It is the responsibility of Congress to recognize that citizenship in this country is a privilege for those of foreign birth - and not an "alien right". It is Congress' duty to protect the national integrity, through discrete selection of those permitted entry.

America welcomed the refugees from Castro's Cuba, but there was more than the issue of sanctuary, even there. The "bracero" program for Mexicans was reneged on by Congress, resulting in the "illegals" swarming across the border. Foreign exchange students swelled the flood, bringing alien ideas right into the American home. Pressures for "adopting" foreign children by proxy, escalated into outright adoptions by nonethnics. Then, the tragic end to the Vietnamese nightmare, and the "boat people". A new, stronger prospect of an unending stream from Latin and South American 'revolutions' increases the threat from that quarter, and now the China 'revolt' holds additional possibilities of hordes of refugees, in addition to Chinese nationals holding temporary visas here, seeking asylum.

And, all the while, native Americans are encouraged to limit their families, abort their unborn children, and welcome these huddled masses in their place.

Under the circumstances, it would be less than human, not to empathize with these unfortunate pawns but one would have to be more than mortal, not to resent and resist the threat they hold to continuance of the American dream.

Even the Federal Council of Churches didn't ask the United States to adopt freedom of immigration unilaterally. It has taken muddle-headed liberals in Congress to lead the way to a modern-day Tower of Babel here, despite the absence of acceptance of such a patent idiocy by other countries.

If there are any statesmen in Congress today, the question of "immigration" will be brought up again, and addressed on its DEmerits. If there is none bold enough to buck this current now, that can be remedied at the polls.



Arguably, the most important act of the Carter administration was the agreement it made about Panama. In time, the decision made then assumed an even greater import than was apparent in 1977. Although many facts which were presented in opposition to the administration's proposed abrogation of the historic relations between Panama and the U.S. were not considered germane to the decision made then, events have justified the widespread concerns expressed at the time.

In reviewing the steps leading to the signing away of the American presence in Panama, it is evident that matters directly affecting the action taken were calculatedly pushed aside.

Perhaps the most important such matter was the deliberate denial by the Carter administration of the "democratic" ideals it so piously proclaimed. Not only was the "treaty" not in response to the desires of either the American people or those who lived in the Zone, but poll after poll showed that 70 to 90% of Americans opposed abrogating the original agreement on Panama.

Of prime importance, too, and not taken into account, was the revelation in the official Soviet military organ, "Red Star", in June of 1977, which identified the Canal Zone as a "priority" territory marked for Soviet conquest, continuing the historic Soviet pattern of international subversion. Breaking the ties between Panama and America not only gave greater opportunity for a Marxist takeover there, it left the Territory at the mercy of the likes of Noriega.

In the Soviet blueprint for global conquest, Panama has always been an essential element in the Lenin-planned encirclement of the United States, which, combined with internal subversion, would "eliminate the need for armed aggression". America would fall into the Soviet orbit "like a ripe fruit".

The "laundering" of political funds, which the mass media takes delight in exposing, is small potatoes, compared with the "laundering" of reputations, long since stained by their possessors.

One such reputation which received a cleansing in the mid-70s had direct relation to the Panama situation. It belonged to Alger Hiss.

Treated by the media as a long overdue correction of a monstrous injustice, the Hiss 'reinstatement' echoed the "respectability" being bestowed on the Soviet Union through detente, glasnost and perestroika. It was of some immediate import, because it was followed in short order by the debates over Panama. Among Alger Hiss' deeds was one monstrous betrayal which laid the foundation for the Canal problem. That betrayal is (and was then) a non-issue to the press, but it was a vital element in United States history.

The Hiss-Chambers confrontation has had extensive coverage in books and articles, but, to find the key to the Panama problem, musty government records must be sought and studied - a difficult job. So, for the record, a brief summary:

Having realized unimagined advantages as a result of world war 2, the Soviets had stepped up their subversive activities worldwide, never losing sight, however, of their designated prime target - the United States. Penetration of Mexico was ongoing, and agitation in Latin America was insistent over the years. Success in Cuba was an invaluable victory. But Panama held a high priority in the Soviet scheme for world conquest.

The strategic Soviet thrust at Panama had been to challenge the right of the United States to have a presence there. Basic to validating that right are the provisions of the 1903 treaty (qv).

In 1946, the newly formed United Nations conducted a survey of the nations of the world, preliminary to beginning to function under its Charter. The Republic of Panama presented its official statement to the UN authority, including the facts about U.S. involvement there. That statement has never been challenged, except by the communists, and that unofficially.

The Panama delegation reported:

"The strip of land known as the Panama Canal Zone has been neither purchased, conquered, annexed, ceded nor leased, nor has its sovereignty been transferred to the United States. ...

"There is no native population. There is no permanent population. ...the land is solely inhabited by officials, employees, and workers of the Panama Canal, and by the families of these... They live in the Zone while they are working for the Canal... When a person has stopped working for the Canal, he must depart from the Zone. In consequence, the population of that territory changes constantly...it has no interest there, nor political aspirations for independence..."\* (Emp.added-ed.)

"Self-government" is the critical issue. It was under Article 73 (e) of the U.N. Charter that Alger Hiss placed the Zone in jeopardy, and laid the groundwork for the turmoil over Panama today.

Article 73 (e) calls on U.N. Member States who "...have or assume responsibilities for...territories whose people have not yet attained a full measure of self-government..." to make regular reports to the Secretary General. "not yet" is the operative phrase.

In his position as an UnderSecretary of State for Political Affairs, but without authority or even the knowledge of his superiors, Alger Hiss secretly prepared and delivered to the UN Secretariat a paper which placed the United States relationship with the Canal Zone as one of trust, awaiting the time for "a full measure of self-government".

Officials at State, learning of this paper, tried frantically to divert delivery, but the perpetrator of the fraud was nowhere to be found, and no one else knew how the paper was being delivered. The damage was done, and, by this means, Panama was identified for the record as being denied free political exercise (by the United States).

Spruille Braden, who was the Secretary in Charge of Latin American Affairs in the State Department at that time, testified to the Senate Internal Security Subcommittee about the Hiss action. He pointed out that, so far as the Republic of Panama was concerned, the Zone was, and had been since 1903, "self-governing", and that Hiss had not only exceeded his authority by making that report to the U.N. without approval of his superiors, but had "opened a Pandora's box of troubles" for the United States.

The Hiss submission to the U.N. caused a furor in Washington. Most of officialdom first learned of it by reading the Washington Post.

As a result of that one act, by a man who was officially found to be "an underground agent of the USSR", the friendly Panamanians were outraged; a number of other Latin-American nations were alienated; the Soviets received confirmation from a high-ranking American official that their

contention about American 'imperialism' was true; and, most importantly, the U.N. received a valid claim to a stake in the operations of the Canal.

That is why there is trouble in Panama today. It could have been Alger Hiss that Joe McCarthy had in mind, when he told that audience in Wheeling, "...we are not just dealing with spies who get thirty pieces of silver for stealing blueprints. We are dealing with a far more sinister activity, because it permits the enemy to guide and shape our policy."

Communist agitation in Panama has accelerated, with increasing success, until the Soviet objective there was granted sanction by the man in the highest office in the U.S. of A.

A Pandora's box, indeed.

The inroads made by the Soviets in governments all over the world are perceivably greater today. The deepening red hue in the Carribean; increased activity in Mexico and other central American States, the problems in Nicaragua and El Salvador. In view of these facts, the insistence of the Carter State Department and the White House on the new "treaty" spelled disaster.

The "new treaty" with Panama realigned our position there into the old communist blueprint.

But the question of whether or not the document brought back from Panama by "our" negotiator is a treaty at all, should be examined. Sol Linowitz, named by the Resident of the White House to act for the United States in the Panama situation, was not confirmed in that capacity by the Senate, as required by the Constitution, so he was without portfolio, and, therefor, without authority.

Possibly because there was concern lest the Senate actually reject the appointment, due to the adverse nature of the information available about Linowitz, the so-called negotiations were carried on with undue haste, in a seeming effort to get the job done before the damascan sword of Senate disapproval fell. That haste raised legitimate concern. The public was continually being soothed with the promise of a long-range target date, such as the year 2000, comfortably distant from 1977, but factually irrelevant to the total situation.

The paper which was signed on 7 September 1977 with all pomp and ceremony, if anything, was no more than an agreement on general principles, made by those promoting it - and none other.

A peculiar question of international law was raised because of the Carter administration action. There was no country of Panama in 1903. At that time, Panama was a city in Colombia, and, despite some obscure machinations, the treaty was made with the Republic of Columbia. How, then, can that country be bypassed, in any renegotiation? A treaty, to all intent and purpose, is an equivalent of law, and a law can only be modified by the same body which created it.

Another vital fact, which has been deliberately obfuscated, is that there most definitely is a 'communist' conspiracy for world conquest. From world war 1 until the mid 1960s, United States security agencies were continuously engaged in documenting that conspiracy, its strategies, tactics, and personnel.

It is passing strange how the news media, so fiercely righteous in opposition to "rightwing" governments, finds "leftwing" militant coups completely acceptable. Thus, the newshounds choked on the "rightwing" Chilean revolt, but easily swallowed the Marxist takeover in Panama, and actively promoted cooperation with that illegal regime.

Instead of playing God with the future of this great globe by voting to

approve the Carter initiative for Panama, the United States Senate should have been preparing American citizens to cope with the problems caused by the Executive action which set up Panama for the trouble there today.

Reference:

1954 Annual Report, 83rd Congress; 2nd Session: Subcommittee to Investigate the Administration of the Internal Security Act and other Internal Security Laws, 2 January, 1955.

A committee of Congress once published a report on the Communist use of language as a subversive weapon. Today, practically everything published - by government, by the media, and general information in books, magazines, on radio and TV - may fall into a "subversive weapon" category, should be viewed as suspect, and examined with a questioning mind. This is equally true of much of the so-called 'conservative' literature.

The first question (which should be constantly asked of oneself on every issue or situation) is, what purpose is being served? Only when the true purpose has been determined can one safely relax the vigil, and accept that purpose as a guide to evaluating the message.

It is a constant source of amazement to find how thoroughly language can be perverted, so that it seems to be saying one thing, but, actually, is giving a deliberately false impression. As regards some of the apparently 'conservative' material, there are additional problems. The language may clearly and correctly state the case, but suggested action sometimes is diversionary, sometimes supports the hegelian predetermined 'solution'. Increasingly, books and pamphlets are appearing which purport to be 'conservative', but stem from either the so-called "new right", or even "new age", which have a demonstrable divergence from the general output of traditional 'conservative' writing.

One of the most flagrant examples of the use of language as a subversive technique exists in the bills which were passed in California to introduce the management and control system into government departments. Those bills were a classic in this technique. Even when one became aware that those bills created the permission for The System, it took careful examination to determine HOW they did that. Only one legislator in California apparently saw the true purpose of those bills, and he only voted against one of them. Of course, others might have known. One who might could have been the 'author', but that doesn't necessarily follow. So carefully were those bills worded to mislead, that it is easy to understand that even the legislator who submitted them might not have known what they really would do. They might have been 'slip' bills, prepared in one of the numerous incubators of the Rockefeller 1313 conglomerate. We do know that those bills were sent to the Legislature by the Governor's Office, and the 'legislative author' was simply the conduit to drop them in the hopper.

When we began to try to trace the development of that management system, one of the first offices we approached for information was that of the Committee created by the California Legislature to develop The System.

As we waited for someone to come out and discuss the PPBS with us, we noted a small bookshelf beside the front desk, with a dozen or so books neatly arranged on top of it. Being a 'bookworm' it was almost involuntary for me to wander over and examine them. Several had unfamiliar terminology in their titles, but one was quickly recognized as a book which had puzzled me ten years earlier. It was called "Goals for Americans", and subtitled "The Report of the President's Commission on National Goals". I found myself wondering why that Report of so long ago was of interest in an office in which a modern management system was being developed.

I remembered when I first read that Report on National Goals, the impression it left with me was that the Commission on Goals was apparently

another boondoggle (which was what exercises in bureaucracy used to be called) - much sound and fury, and little significance. I could not understand why thousands of copies of pamphlets which gave a synopsis of the Report were distributed gratis, when it was published in paperback at nominal cost, which anyone interested could afford. Seeing it now, here in that office, prompted me to dig out my copy when I got home, and read it again.

This time, I understood.

This little book is a consummate example of the use of language to deceive the electorate - and those they elect.

When Dwight David Eisenhower appointed the President's Commission on National Goals, he chose Establishment people to man the panel. Of the eleven Members, seven were also members of the elitist Council on Foreign Relations; two were university professors; one was president of the AFL/CIO; and the last was a retired judge of the U.S. Court of Appeals.

The Commission was privately funded, which effectively denied Congressional oversight. The presence of those Establishment persons assured control of any Goals they might determine.

Should you doubt the ability of such a Commission to develop a set of Goals supportive of elitist programs, which would have a prayer of being implemented, the source of the Commission's funding should leave no doubt. Credit is given in the Preface of the Report to the Carnegie, Ford, Rockefeller and Sloan Foundations, among others.

If that isn't enough to demonstrate something more than bureaucratic fun and games, the whole effort was produced under the auspices of the American Assembly, another Establishment front.

But, you see, when I first read this report (circa 1960), I didn't know these things were important. Neither did I know that this was a strategy which had been successfully used in 1930 to produce Herbert Hoover's Report on Recent Social Trends, which was prelude to the Planned Society. So I had no foundation for believing that "Goals for Americans" was the prelude to another phase of the revolution. And I dismissed it, as, I do believe, most who read it then did, with no inkling of its potential. Unlike me, few people are likely to have had an experience such as this, which caused them to study it again, later, when events had given it import which was not visible at first reading.

The Report opens with an Introduction which appears to be a ringing salute to "the paramount goal of the United States", as that Goal was set by the Founding Fathers. Interlaced in the praise was an implication that that Goal was also the goal of the Commission. But with a difference. For, as they expounded on that original Goal, these latter-day founding fathers included the concept that government is responsible for ensuring the welfare of the citizens, their development, and their opportunities. The Commission also presumed to enlarge the original goal of this nation, to "an even broader and bolder declaration than those who (created that Goal) knew".

That "expansion" of the original Goal is the basis for many of the interventions causing so much trouble today - including the control system.

In that Introduction to these 'new' goals, this group of elitists also stated that the legal government of this nation rests on two "fundamental principles": election of representatives, and constitutional limitation of power of those elected. While many Americans might well accept those two "principles" as valid, the truth is that NEITHER of these were Goals as put

forth in the Declaration of Independence, nor are they major thrusts of the Constitution. Separation of powers of government; limitation of power of the central government - these were the major goals expressed - the first in the Constitution, itself, the second in the Bill of Rights.

The Introduction of the Report also states that "The way to preserve freedom is to live it", a questionable premise, but easily accepted, if there is no reason for doubting what is being said. But the Commission leaps from that to reveal that their aim is to "build a NEW nation, and help build a world."

And THAT is what these new Goals were designed to do, as the record shows.

Were it not for the fact that these Goals have been diligently promoted ever since they were announced in this Report, it would be of little value to discuss them, now. But they have been insistently pursued, so it is vital today to know what they are. Not knowing about these new goals is the basic reason why Americans have difficulty "making sense" out of the programs being implemented today.

Goal No. 1 is of paramount importance, for in it is revealed the main thrust of the rest of the Goals.

GOAL No. 1 is aimed at the takeover by 'government' of every facet of the citizen's life.

Government' is to:

- \*enhance the citizens' dignity;
- \*promote maximum development of the citizen's capabilities;
- \*stimulate his personal development and
- \*provide opportunities for its use.

GOAL No. 2 is to eliminate discrimination;

GOAL No. 3 is to "preserve and protect democracy";

GOAL No. 4 is for total involvement of education in building that "new world":

\*new techniques and strategies in teaching (global ed; behavioral modification; systems programming, US/USSR educational exchange, etc.);

\*more "federal funds" to facilitate these changes (ESEA '65, et al);

\*provision of a standard "norm"

GOAL No. 5 is to "realize":

\*full understanding of the world;

\*high priority for "arts and sciences", with increased federal funding for both;

\*initiation of "manpower development reform";

and, finally, of all things:

\*reform of television performance!

(Just LOOK at the changes in TV since 1960! Was THIS what was meant by "reform"?)

GOAL No. 6 is to provide government participation in the economy (known today as "privatization");

GOAL No. 7 is an open Call for government management of the economy (PPBS; 'stagflation'; supply-side economics)

GOAL No. 8 calls for "technological change" (appears to be the impetus for total land use planning (LUP) by government, PWEDA '65, EOs et al);

GOAL No. 9 calls for interventions in agriculture:

\*"To avoid shock to the economy, this goal should be approached in gradual stages"  
(even then, it is shocking, as any farmer could testify today, and, specifically, farmers Kaul and Kirk, who were killed trying to resist)

GOAL No. 10 addresses "living conditions";

\*Land Use Planning (LUP), again;  
\*urban renewal;  
\*"containing urban sprawl" (Reagan's "dream"/Brown's Strategy q.v. later);  
\*withholding federal "aid" to resistant areas, or areas which do not comply with federal standards;

GOAL No. 11 specifies programs for Health and Welfare:

\*"identify problems...in order that 'government' may formulate wiser policies of regulation..."

Number 11 is the key to it all: regulation - and the consequent need for management and control, as acknowledged in Goal # 7.

Having reread this Report, I found it perfectly clear why it was on the desk in the office of the Committee directed by the California Legislature to develop the control system for that State.

Before anyone cries "Foul!", and charges this is out of context, let it proudly be admitted that it is, indeed, out of context. It is only by taking a nut out of the shell that the meat is digestible. It is only by taking the meat of these "goals" out of context that they can be viewed by the average person in their essential nature. I KNOW! I read this once as your average American, and all I saw was nuts.

Read again, with knowledge of ensuing events, the true nature of these Goals is no longer obscure.

Simply reading this deliberately obfuscated program of Goals, as prepared for public consumption, would not make the case against them. Remember, they were prepared by experts to produce public acceptance of new goals for America, disguised as simply extension of the original Goal. How much this little book has had the intended effect cannot be determined, but public resistance to these unAmerican concepts is at a low ebb.

The whole document was written to obtain support from the grassroots, and it seems that has been achieved. To be against such sweet sounding Goals as these are made to seem in the context of this Report, would be in the realm of rejecting apple pie and motherhood. Or lese majeste. Or, at the least, against progress.

As for "foul" - if all's fair in love and war (and politics, remember, is another form of war), 'foul' is a nonsequitor. If it is foul to expose wrongdoing, so be it.

There is no legal justification for what is being done in this program by these mattoids.

They fatten at the public trough, while their intended victims go broke, trying to defend their heritage and themselves directly, against



this abuse of power.

These, who deliberately and fraudulently conceal their true purpose and goal, are worse than prostitutes peddling their illicit trade to 'consenting adults', who see only the surface 'favors', and do not know (or who sublimate their knowledge), that they are risking everything worthwhile for momentary gratification. This is not "momentary gratification". This program is meant to be total and forever.

Evil men have always attempted to perform evil deeds. It has been so since the world began. Because it is still so, the debauching of America is proceeding without let. Those who should be on guard, are not, and there is no one to raid the premises where such deeds are schemed and planned.

Recommended Reading:

Goals for Americans - American Assembly, 1960

"The Brass Check", Upton Sinclair, self published, 1919

ON THE ROAD TO REVOLUTION - 30 - The Supreme Court  
as an Agent of Change

When the Constitution of the United States was hammered out that hot summer in Philadelphia, every effort was made to avoid the pitfalls which history had shown led to untimely ends for other governments.

Having experienced tyranny, the settlers here were determined to prevent once and for all the forging of shackles for the citizens such as tyrants had ever devised for subjects. Instead, our forebears placed the shackles on the government, leaving the citizens in control of the Ship of State.

The Supreme Court was created to be a bulwark against usurpation, and to ensure that the government provided would be continued under law, or, if altered, that, too, would be by law. The Supreme Court was delegated the responsibility of guarding the general liberties of the people, being given the authority to examine any and all acts which might not be consonant with the intent of the Constitution. During the time when it performed in the manner intended, the Supreme Court served its purpose, and these United States grew and prospered - and the citizenry did likewise. The fabled opportunities which existed in this "land of plenty" were the direct result of an inspired government, monitored by an honorable Court following tried and proven procedures and precedents.

Through the ages, though, there had been this elitist dream to play God, and direct the destinies of all mankind. The Founding Fathers were well aware of this tendency by some men to want dominion over their fellows, and specifically recognized it by attempting to build effective restraints against any usurpation of power. But they could not envision a time when conniving men would possess the ultimate power attainable in this world - a means of directing the mental processes of mankind. How could they guard against something which neither existed at the time, nor could possibly have been foreseen?

During the last century, an assortment of elitist groups emerged, each holding a variant of the "impossible dream" as an unholy grail. Each drew recruits from amongst their own strata of society, and from the dregs of humanity, but the great middle sector of mankind was not drawn to misty dreams, especially in the United States.

Opportunity unlimited - that was the American dream. Deeply religious, most Americans knew that Utopia was not of this world - the Bible told them so.

Religion was the greatest obstacle to the elitist dream, and the revolutionaries have clearly recognized that fact. The churches became the primary objective for their machinations. Infiltration there began a long time ago, and has never ceased. Karl Prussion told of the communist plan to send him into the ministry, to carry out his subversion there. He was taken to the head of the largest seminary in the United States, and of him, Prussion said, "I shook his hand, and called him Comrade." Internal agents such as that were abetted by external attacks, creating a pincer movement against organized religion, with devastating effect on all faiths.

Once mastery of control of men's minds by scientific methods was assured, all politico-socio-economic avenues leading to realization of that ages-old dream, became targetted. Political structures; education, and all

related matters; transportation, and the rest followed in such swift forays that determination of their succession is difficult to ascertain.

But, somewhere along the way, the Supreme Court was drawn into orbit, and began to take its place as an agent of national dissolution.

Probably nothing the Court has done brings their role into focus more clearly than the infamous "separation of church and state" decision, which laid the ground for all related later cases. That decision involved a case where a local school board had encouraged children to say a grace before snacking, at school. The Supreme Court, responding to a challenge, finally determined that this violated the first amendment, thus setting a precedent which has circumscribed all religious practices which in any way impinge government involvement.

That the Court did not base that decision on the fact, is implicit in the First Amendment itself, which they cited.

The first amendment clearly and concisely states that "CONGRESS (not a local school board!) "shall make no law" (not about prayer, but) "respecting the establishment of a religion".

Freedom of religious practice was the lodestar which brought the Pilgrims to these shores, and it was the keystone of our government. So that they would be free to worship as they chose, without a government-established religion, this vital issue was settled (for all time, they hoped) by the First Amendment.

The next clause in the First Amendment confirms that by providing that there be NO "prohibiting the free exercise" of religion. A local school board, acting as the agent of the parents of their wards, was NOT "establishing a religion" with that prayer. They were allowing the free exercise of worship.

In their holding in this case, the Court violated the 9th and 10th Amendments, and the 1st, itself.

This precedent-setting case, therefore, found the Supreme Court clearly rejecting their Constitutional role of guardian of the people's liberties, and assuming the role of agent-of-change - opening a floodgate of attacks on the people's right to practice whatever religion they adhere to, in whatever manner they choose.

Recommended Reading:

"Undermining the Constitution" Thomas J. Norton - Devin Adair  
- 1950

"The Constitution of the United States" ibid - 1922

"Nine Men Against America" Rosalie M. Gordon, Devin Adair, 1960

"Special Report on Problems Caused by Recent Supreme Court Decisions"  
Harold Kennedy, L. A. County Counsel 19 August, 1969

Hidden away in the California Constitution, 21st in a series of 25 Articles on a variety of subjects, is a time bomb, approved by the people of that State 60 years ago.

What illusion was created to obtain passage of that section is lost in the mist of time, but all this while it has lain dormant, unused until 1966, when the Legislature lit the fuse by passing enabling legislation.

Not that the 1966 legislators necessarily knew that they were lighting a fuse when they passed the bills which activated the bomb. Unless they had done a great deal of homework, they wouldn't be likely to know - and what legislators do their own research these days, with all those aides and consultants to do it for them?

IF they had, however, they would have found, in Section 21 of Article XXV, the Constitutional "authority" for that legislation, and they MIGHT not have approved it. They MIGHT, even, have taken that Section back to the people for corrective action.

That Section begins:

"The legislature is hereby expressly vested with plenary power, unlimited by any provisions of this Constitution, to create, and enforce, a complete system of workers' compensation..."

"...unlimited by any provisions of this Constitution..." is the time bomb.

In 1970, the State Constitution Revision Commission (CRC) considered revising this Section, but, by a "narrowly divided vote" restrained themselves. Those learned citizens recognized what it would mean to have so vital a matter brought up in debate before the people. They noted that any change "would disturb the (workman's comp) system", and that, "obviously" the words didn't mean what they appeared to say, since "no one would think that it intended to eliminate the provisions of the Constitution with respect to equality before the law, or with making gifts of public money" and the CRC quietly passed over Section 21.

Very interesting, the sections the Commission chose to cite as being beyond believing that anyone would intend to negate them. "Equality before the law" was what the Court found existed in the oppressive rulings of the Tahoe Regional Agency, since, the Court said, the same treatment would hold in any other regional area.

Any credibility that 'disbelief' expressed by the CRC was made moot by the legislative action which had resulted in 1966 from this unlimited delegation of plenary power given the stamp of approval by hands long gone before the damage they permitted was done. In that law, an appointed Board is given "full power, authority and jurisdiction... with all the requisite governmental functions" - over ALL workmen's compensation disputes. But the CRC only looked at the Constitution - not the enabling legislation. And so, a large group of American citizens lost the protections of the Bill of Rights.

Right of redress, ostensibly protected by both State and Federal Constitutions, is effectively denied to any citizen of average means who gets caught up in this nightmare of nonjustice.

- \* ONE MAN determines, first, jurisdiction;
- \* ONE MAN becomes judge and jury;
- \* ONE MAN determines the decision;
- \* ONE MAN makes the award;
- \* ONE MAN decides the amount; and that same
- \* ONE MAN is empowered to enforce his own judgement.

He may place liens against everything the victim owns, up to the amount of the award. The victim may not turn to the real courts, and a jury of his peers, nor even challenge jurisdiction - without posting a bond DOUBLE the amount found against him - an impossibility for the average citizen, when the amount of the award can be equal to all his assets.

Despite the comforting determination of the Revision Commission, the unlimited plenary power delegated in this Section of the California Constitution shatters the carefully provided protection from government each citizen is entitled to have.

But that is a time bomb in only one State. How many other States have such provisions lying dormant, waiting for the fuse to be lit? Have you studied YOUR State Constitution? Can you be sure there is no such provision waiting to destroy your security?

Those who would deny the "conspiracy theory" of planned destruction of our government would do well to study this matter carefully. Look at your own State Constitutions, and then check the amendments to the federal Constitution, which have followed the Bill of Rights.

The Federal Constitution is a grant of powers from the people and the States; the Bill of Rights placed restrictions on those powers. Both applied to the Federal Government ONLY.

Nine of the sixteen amendments which were passed after adoption of the Bill of Rights, grant additional power to Congress (the federal government). These are federal time bombs, which have been detonating regularly. Small explosions, mainly, but some of great magnitude. ALL traceable to these additional grants of power.

But all these are minor bombs, compared to the nuclear force embodied in the proposed so-called "Equal Rights" amendment. Insistently proposed since the 1920s, the Equal Rights Amendment would be precisely that - equal rights for all citizens to enjoy the "equality before the law" which the citizens at Tahoe have, and which are available to any citizen of California who runs afoul of the Workmen's Compensation Board. Equal right to have no Bill of Rights.

For the ERA is limited ONLY to those matters where male/female are involved, and it is in those areas where the Bill of Rights applies. Male/female are all the citizens we have. The Bill of Rights prohibits the federal government from exercising those certain powers against the citizens. The ERA gives the Federal government those reserved powers which were insisted on as a condition of acceptance of the Constitution.

The ERA has been called a "people's amendment", because it mandates equality to both sexes. It doesn't define equality, however. Equal tyranny, as at Tahoe?

Only color of law was granted in that amendment to the California Constitution of so long ago. Plenary power given to an appointed 'aritrator' is a travesty. Plenary power is granted by the ERA to the Federal government, and it would be exercised by appointed minions. It would nullify, not just the rights of the citizens, but of the States as

well, because in it that power is granted to the federal government, bypassing States' rights.

The words of a school superintendent in Palos Verdes, California, echo down the years, as proponents of "equal rights" continue to press for passage of their essential revolutionary weapon:

"We shall have another election, and another, and another, until we win."

The revolutionaries dedicate the whole of their lives to their cause. Unless that dedication is met with equal strength, the end is predictable. Watchmen - what of the night?

Recommended Reading:

"The Plan for Lake Tahoe" documented by KMH, available from John Hart Library

The complete series of Federal Constitutional Amendments

As the cybernetic society begins to take visible form, even the man-in-the-street begins to "view with alarm" the evidence that the body politic is suffering convulsions from some massive internal disorder. An excellent diagnosis of the illness afflicting our society appeared twenty years ago, in the February, 1970 issue of "Trans-Action" a slick elitist magazine.

The writer had impeccable credentials as a research assistant at Brookings Institute (a 'thinktank' operation). He was a former 'RAND'sman (RAND is another 'thinktank'), and had other prestigious connections. Allen Schick wrote with confidence about the Cybernetic Society, as well he might, being in the thick of the inner circle which was even then creating it. His article was frighteningly accurate, as it related the events leading to the Cybernetic Society. It became even more disturbing, as he moved from what WAS in 1970, to what IS - twenty years later. Especially since he wrote as though the cybernetic society was even then solidly in place.

It is regrettable that Mr Schick was studiously non-critical of the matters he wrote about, for given his evident talents, he could have been an invaluable ally for liberty. As he calmly reported on the sequential incidents which 'happened' to take this nation on the path it followed, the impression was created that "C" followed "B", which followed "A", as morning follows night, which follows evening. One is left with the feeling that it was an inexorable progression, following a natural course, not subject to alteration or intervention.

Terming the government provided in our Constitution a "political state", Schick posited that the so-called industrial revolution and the growth of huge corporate conglomerates led to unrestrained regulation by 'government' and to the emergence of the "administrative state". There is no suggestion that the administrative state was in fact, as the record shows, a planned development.

New Deal activities, Schick avers, opened the door to the "bureaucratic state", which inevitably led to the "cybernetic state". Again, no recognition of the extensive evidence of a planned program to achieve these "states".

Schick did not question either the legality or the Constitutionality of these changes. He simply viewed them as natural phenomena. He pointed out that, before administrative governance, the Constitutional rules of representation still applied, but with the emergence of regulatory agencies, advisory boards, and other appointive offices, Congress was "liberated" from representation, for Congress "can no longer exercise close supervision of their action." (Mr Schick's article was written about the time that the Courts were 'finding' that to be a legal principle.)

As the only establishment figure to my knowledge who admits that the role of the Supreme Court, during the time he designated as "the political state", was in fact interpreter of events relative to the Constitution, it is disappointing to find that Mr Schick found no fault when the role of the Court changed to being a rubber stamp for administrative governance, with no lawful authority for that change, and that he nodded approvingly at the Court's increased emphasis on separation of public and private affairs, and of administrative and political matters - all without changing the

Constitution to permit them.

Schick pointed out that the "bureaucratic state", which followed the administrative phase, began the change from government regulation of business and citizen action, to government operation of businesses, and control of the citizens. According to Schick, at this point, "participatory democracy" became important, as citizens found they could no longer control the bureaucracy through their elected representatives, who had forfeited their Constitutional duties to appointed administrators. Schick describes how bureaucrats used citizen activists to support their demands on Congress and the President; how Congress looked to the citizen groups for approval of what was being done in their name (seen any good opinion polls lately?); and the presidency used such groups to mobilize the apathetic voters or to act as go-between for him and the masses. Schick ignores the essential element of 'representation', which is that government responds to the will of the people. Obtaining 'consent' by such contrived means as group dynamics or Delphi is NOT what the Constitution is about.

Mr Schick also did not discuss in this area how, once the cybernetic state was in place, participatory democracy would have to be phased out. Neither did he expound on how it could operate to further the march into the cybernetic society on its own initiative, once the people learned how democracy could be used to achieve a goal not shared by the majority of a constituency.

Development of crowd control techniques such as group dynamics, Delphi, sensitivity training and numerous other variants, opened the door for "democracy" to perform entirely apart from the official political moves, all the while supporting the official goal.

These events also affected the Court, where decisions turned from passive examination of impact on the Constitution, to active participation in the political process. The Court upheld nationalization of human rights (as in 'civil rights'), applying federal standards to an ever-broadening police power in the States, in defiance of the 9th and 10th amendments. As the cybernetic age dawned, Schick pointed out, the Court function again changed. From telling the government what it must not do, it began instructing the government in what it MUST do.

Mr Schick focusses on the fact that the lines between public and private sectors began to diminish, as governmental regulation became endemic. 'Government' also began to change. From a 'doer' of public acts, it became a distributor and withholder of public benefits. Schick noted that, in 1970, cybernetic programs were still embryonic; government lacked the capability of controlling and monitoring all the factors the system demanded. Twenty years later, 'government' has achieved a substantial capability in all elements of cybernetics.

As public/private boundaries disappear, a similar disintegration takes place in the political, bureaucratic and administrative spheres. Administrative action becomes politicized, political action becomes bureaucratized. As Schick stated, "The supreme political action of determining legislative districts has been turned over to computer specialists." (We couldn't agree more. We think you will also find it so, when you read in this book the sad tale of the California experience with "reapportionment".)

Policy determinations had become dependent on "the internal dynamics of the (political) organization", Schick reported. In making decisions, public officials now rely on reports, past budgets, data, money available, staff experts and the cybernetic goals, instead on the needs and desires of



the citizens.

America now, in the last decade of the 20th century, is in the ultimate cybernetic state. Pro forma representation still exists, but the elected officials are listening to a different drummer than that which beats out the song of America. Elections are still held, but they have no meaning. The only real issues are non-issues to today's candidates. The caliber of most of the people who offer for election is such that most of them accept this ersatz means of governance without question.

It will take a calculated, strenuous, courageous effort to replace a majority of those now holding office with people who understand these things, and are willing to place themselves and their reputations on the line to support, defend and restore our Constitution and the good life it provided.

That is the only way post-Constitutional America can be nullified.

He was one of the more obscure establishment persons, and the subject had no apparent pertinence to anything being reported at that time on the 'news', so the immediate question had to be, "Why was Tom Braden, erstwhile smalltown, California publisher/editor, longtime supporter of 'liberals' and their causes, vicious anti-'conservative', brought into prime national TV newstime, to discuss what he called The Fifth Estate?"

The fact that this interview took place at all, lends more importance to the matters discussed than they might seem to have.

The first "Three Estates", are, of course, the lawful government of the United States - legislative, judicial, executive. To those, in time, was added a "Fourth Estate" - the press. But now, here was Braden, assisted by NBC's David Hartman, gratuitously pointing out that there is now a Fifth Estate - the army of nameless, faceless, persons who do much of the work for which "representatives" are elected.

Was this another attempt to quiet the restless natives? (Braden made a point of saying that "nothing could be done" about it.) Was the subject somehow tied to the then-current "investigations" about security? (Braden said that it was impossible to provide protection for confidential matters, due to the Fifth Estate.) His open reference to these two possible reasons for his appearance, probably eliminates them as cause for the interview. Past experience has shown that the "insiders" usually have some oblique motive for the moves they make, and they never but never give the true reasons for their moves.

Braden spoke of the more than 30,000 secretaries, assistants, and other staff in Washington D.C. alone, who develop the position papers for elected officials, write their speeches, answer their mail, and otherwise relieve them of the labors of public office. These are duly on the payroll, so, presumably, they are subject to some kind of control.

In addition to these, Braden said, there are about 3,000 unpaid "volunteers", with access to everything in a congressional or senatorial office. These are "brilliant scholars", college students, or political supporters of the incumbent, identities not necessarily mutually exclusive. These do not have ID cards, nor are they accountable for their background, activities, or intent.

While not in any way impugning those among them who have no ulterior motive (and there are surely some of those), the dangers involved in the equivalent of a military division of unauthorized volunteers supposedly doing the "people's business", cannot be overstated.

One remembers Beria's psychopoliticians with a cold shiver. These swarms of the unelected abound in the States, as well as in Washington. In the light of the record of once-staunch Americans who held office, and who betrayed the trust given them by their constituents through personal degradation, psychopolitics becomes more believable.

One cannot, for instance, imagine John Schmitz, longtime California Senator, effective Congressman (with an unexcelled voting record in both seats), sometime candidate for President, devoted husband and father, loyal friend, devout Catholic, dedicated foe of aberrant sexual behavior, casting off all his lifelong principals and qualities of character on his own initiative, betraying his wife and his eight children (not to mention the thousands of his supporters), and "shacking up" with one of his campaign workers. But as a result of psychopolitical manipulation, such behavior is

precisely what can be expected.

When Tom Braden's "volunteers" are viewed in the context of formal governmental precautions (resumes, job applications, security checks, closed circuit TV, and the like), it is passing strange to find that these people have the run of the Capitol office buildings, sans accountability.

Referenced to a speech made in the House at this proximate time but on a different subject, this army of volunteers could well assume the aspect of a Fifth Column, rather than Mr Braden's Fifth Estate.

While bringing out such information, as Mr Braden did, is an admirable endeavor, it is counterproductive to assert that nothing can be done about it, unless that was the goal - to have nothing done. ANYTHING the government is presently doing can be changed, if the proper corrective steps are taken. This is not to say that the day may not come when that will no longer be true, unless such steps are begun - and that soon.

Over 50 years ago, then-Congressman Samuel Pettengill (D-Indiana) put this situation in perspective, when he wrote that it begs the question to say that it is hard to tell when twilight ends, and night begins. There IS a point, he stated, "beyond which it is night. There is a point, where freedom ends, and despotism begins..."

Perhaps it would be more applicable here, to say that the shadows of despotism foretell the end of freedom. There the simile ends, however, for night MUST fall, and our government need not.

At the heart of the problem, as in so many cases today, is the burgeoning bureaucracy, by which decisions formerly made by elected officials become the purview of these appointed experts. The more control put into their hands, the more hands are needed to exercise the control.

It is futile to pass laws to close loopholes like this - even when those holes are big enough to drive a herd of buffalo through. Only a solution which includes elimination of the unelected decision-makers can correct situations such as this.

Recommended Reading:

"SMOKESCREENS", Samuel Pettengill, "America's Future",

1939

The long awaited moment had arrived. As he strode into the Hearing Room, his whole mien was one of confidence. He was handsome, erect, assured - a prototype of what a responsible young official in the Executive Office of The President should be.

In his position, he had been one of the select few with access to vital information essential to national security and administration of the affairs of state. In his official capacity he had the responsibility of helping to formulate policy, and of developing ways and means of carrying those policies forward.

Now, he was brought before a Committee of the Congress to answer to the manner in which he had discharged his duties.

A groundswell of support from his colleagues in the Executive Office, as well as from the general public, grew as he faced his questioners, and parried their thrusts with remarkable skill. He was articulate, calm in the face of an evident bias in the interrogation, and support for him intensified as the days of his ordeal passed.

His name was Alger Hiss.

The parallel of that long-ago Hearing to the matter of Oliver North appears to trail off at that point. Except that the impact of these two men in the performance of their official duties must continue to affect the course of this Nation.

There may be yet another parallel. If so, it is exceedingly unlikely that it will ever be officially disclosed, especially as it might apply to Oliver North. If such a parallel as I am about to suggest exists, it would be of such extreme importance that to fail to include it as a possible cybernetic exercise would be a dereliction on my part.

It is an established fact that Alger Hiss was under communist discipline all during the time that he was an official in the State Department. Oliver North's testimony about his activity as a member of the group selected to advise his Commander-in-Chief on National Security matters, and the manner in which he presented that testimony, strongly suggest that he, too, might have been under discipline. Not "communist" discipline to be sure, but a control even more sinister.

When the United States Congress passed the National Security (sic) Act of 1947, a whole new spectrum of problems was created - problems far more inimical to the security of this country than those NSA-47 was stated to cure.

Among its provisions, NSA-47 reorganized the separate, autonomous military departments into one, integrated, unified command, creating a structure ideally designed to house the ultimate cybernetic servo-mechanism. In the debates on the bill, this fact was never mentioned. It was not a consideration because at that time, only a select few knew that there was a scheme afoot to revolutionize the conduct of the public business. Only that small, select group knew then that systematic management was the wave of the future - but almost no one else except those directly involved in creating The System did.

Absence of that information permitted a fatal flaw in the decision Congress made on the National Security Act. For, as a result of NSA-47, the Department of Defense became the incubator for the system of management and control, and a cancerous lesion on the body politic.

So what does all this have to do with Oliver North?

Simply this: there is a clear record of activity within the ranks of the educational Establishment, of complicity in development of methods of controlling people, places and things. In the section of this book called "The Common Mind", that situation is explored more thoroughly, but for our purpose here, we offer the following:

Oliver North is of the generation which had the first elements of The System applied to them in the public schools. He would have been in elementary school in the fifties, when radical concepts were rapidly replacing tried and true teaching methods. Indoctrination was replacing education - to what purpose?

In later grades in school there were "sociodramas", group dynamics and other psychological tools to condition future citizens to accept directed reaction to any given situation. All through the years in public school, there were the ubiquitous "cum(ulative) files", which chronicled the conduct of the student sequentially, allowing tracking of his/her reaction to the school experience, as well as academic progress or lack thereof.

Then, in high school, the 'counselor' became a fixture. Counselors could channel the student into future occupation by reviewing the "cum file". But in addition to the record of academic progress, there was also that record of how cooperative or otherwise a student was. Those who were more cooperative, more susceptible to control, could be channeled into occupations where they could best serve the cause of the Establishment. Those who demonstrated strong personal conviction or rebellion to authority could be handled in other ways.

Throughout the school years, American history and government were downplayed. Disinformation and misinformation were introduced into texts. Tried and true values were replaced with a new morality. The continuity of our socio/political heritage became disjointed by redirecting the way these future citizens would view the world and its problems.

It has been said that "in politics nothing ever 'just happens' - if it 'happens', it is because it was planned that way." Isn't it simply too much of a coincidence that all these things which were being introduced into the schools in the 50s just 'happen' to fit as preparations for introduction of The System in its total implementation?

As they might apply to Oliver North, consider again his appearance before Congress as a career officer serving in the Office of the President. All his adult life was spent in the military, where The System had been perfected. Did his school record show him to be a likely candidate for service to a higher cause than run of the mill graduates?

There have been numerous accounts of 'experiments' performed on service personnel, without their knowledge or consent. Documented examples of these experiments vie with each other for their callous disregard of the consequences suffered by the victims, or, indeed, their rights under the Constitution to be secure in their persons. Most widely known of these experiments was probably the deliberate testing of nuclear fallout on unsuspecting GI's in the Nevada desert. Is it too far from reality to suggest that the need for subjects on which to test the effectiveness of systematic control had a limitless supply in the military where it was developed? Was Oliver North programmed for what he was doing in the NSC? We may never know for sure.

What we do know is that Oliver North publicly admitted to performing acts which were not in character for anyone with his background, stated beliefs and intelligence and he testified to those acts with a conviction

which gave them a validity they did not warrant.

What we must know is that cybernetics as a conditioning agent is a clear and present danger to national security in the context of our lawful government, as well as a damoclean sword over the head of each and every citizen who can be used to further the schemes of the mattoids who were able to penetrate the most sensitive redoubt in our security armor - our armed forces.

Oliver North may indeed be the hole in the dike which can become the flood of resistance to PostConstitutional America so dreaded by the Elitists.

As it is today, so it was, back in the days when the whispering winds of change began to increase in force and volume. The "public press" had a noticeable bias against investigative reporting of the who, when, where, what and why of subversion, just as it does today.

Americanist columnists were a vanishing breed. With few exceptions, newspapers which told the truth without fear or favor were isolated, generally known only in a local area.

The number of publishers who would print books detailing the attacks on the American dream could, even then, just about be counted on one hand.

As long ago as 1919, subversion of the press was documented by radical Upton Sinclair, who believed it was done to prevent propagandizing for socialism. Whatever prompted his research, it was thorough - and accurate. His revelations of the ways and means by which the press was taken over are more believable today than they were then.

This void had to be filled by other means.

Citizens who sensed danger in the coming storm, voluntarily took on the task of alerting their fellow Americans. Private newsletters began to obtain wide readership, and multiple copies were made available for further distribution. Individuals began sending messages with their payments for bills. Patriotic businessmen responded with "envelope stuffers" in their monthly statements, and sometimes even speaking out on public issues in their advertising. Inexperienced entrepreneurs became publishers of books, to assure continued availability of the facts on current events.

For their outspoken devotion to country, some of these paid a high price, in boycotts, property damage, or even more drastic retaliation from the promoters of change.

The "bumper strip" was invented, and sometimes targetted the cars of patriots. The short, pointed slogans often brought reprisals - radio aeriels torn off, slashed tires, windshields broken.

Even vandalism, however, did not dampen the ardor of the opposition to the movement which threatened the freedom of all mankind. It only sharpened the focus on the kind of mentality supporting that movement.

One of those "envelope stuffers" read, simply:

"Historians of the future will marvel at the non-resistance of those who had the most to lose".

While there was an obvious point in that statement, there was a secondary note of optimism, for 'historians of the future' would only marvel if the real resistance was successful. The establishment revisionism which was even then replacing honest reporting made THAT a certainty!

Today, history is being changed, even while it is being made. The 'rehabilitation' of those who, early on, assisted in the subversion of the American government, is but one manifestation of the new revisionism. Many of these were "victims" of the work of McCarthy. Those known collaborators, their reputations laundered, now work under a cloak of respectability, while the very name of one of the greatest twentieth century patriots is reviled, and used as a synonym for evil.

Unless and until there is a reversal of direction, favorable historic

recognition of Henry Kissinger's peripatetic diplomacy is assured, despite the inhibitions of some of his most ardent supporters over the manipulation of the internal affairs of Rhodesia, South Africa and Afghanistan, visavis his lack of similar posture concerning human rights and apartheid in the Soviet Union.

The bloody dictator of Red China is revered in death as "HERO - STATESMAN - POET"

The pathetic puppets being offered as presidential timber by the two major parties in this country, are unable to reach the heart of America, despite their programmed presentations which proclaim their dedication to the principles most dear to that heart. What they ARE comes through too clearly for Americans to hear what they say. Efforts to destroy whatever credibility either candidate for the presidential nomination might have had bodes no good for their parts in history if the truth prevails.

Perhaps the most interesting twistory involves the downplaying of establishment issues which are unacceptable to the American public. A case in point is the simultaneous disappearance from the front pages of Panama, after the negative reaction from the citizens over the give-away. Making a non-issue of any effort to expose establishment activity is another example. Yet another is the ease with which the entire media switches from one lead story to some entirely unrelated incident, as if on cue. Vying with that twistory must surely be the capability for continuing "talks" with whatever puppet sits as Head Spokesperson for the Kremlin - talks which wind up with treaty signing, despite the 50 year history of Soviet failure to perform on Treaty obligations. Over and over they prove Krushchev's dictum that "promises are like piecrusts - made to be broken".

Survival of our Constitutional Republic is the number one non-issue today. The "non-people" who, through great sacrifice, have offered alternative candidates on third or fourth Party tickets, are invisible, so far as the mass media is concerned. As with the one man, one vote 'principle', which only applies when it benefits planned 'change', "equal time" is not for those who oppose the Plan. Their place in history is obvious, unless they successfully oppose it.

There is mounting evidence that the Pavlovian "conditioned response" technique has been widely used on the American public for more than a quarter of a century - long before The System surfaced as government policy.

Congress and the Executive have both accepted this totalitarian tool as an official operating procedure in our government. State and local governments have quietly acquiesced to it. Public education is now directed and controlled by it. Private education is being penetrated with it.\* Reapportionment brought it into the political system, where it is now a real threat to free elections. There is a growing willingness among some segments of the public to use mind-changing techniques, such as group dynamics and/or Delphi on an unsuspecting target group to achieve the establishment goals.

No one should marvel at non-resistance. The marvelous thing is that there is so much resistance, and that it is visibly gaining strength.

With the help of God, this momentous year in history will see a revival of the spirit which began the American dream, and a beginning of a return to the ideals and morals which made that dream a reality.

\*For systems penetration of religious education, contact "Catholics for Truth in Education", 1041 East 168 Street, South Holland, Illinois, 60473



# section IV

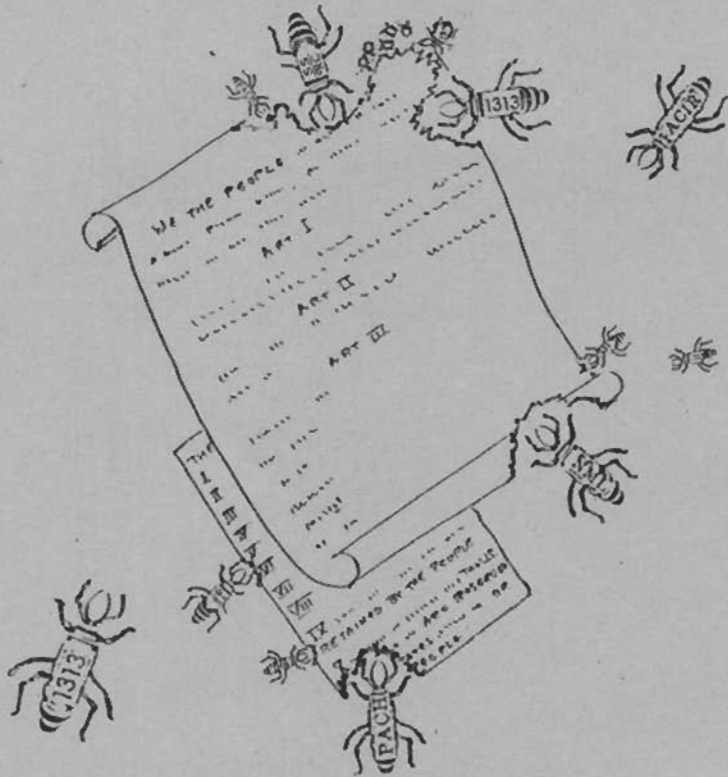

## Political Subversion

ch:	pa:
37 The New Imperative	IV - 1
38 A Vignette of History	IV - 3
39 The New Breed	IV - 7
40 Maintaining the Turf	IV - 9
41 A Strategy of Fraudulence	IV - 14
41 When is a Law Not a Law?	IV - 16
43 None Shall Escape	IV - 18
44 Pity the Gentleman from Ohio	IV - 20
45 Whose Ox Is Gored?	IV - 22
46 On the Job Training	IV - 24
47 How Soon We Forget	IV - 27
48 Deja Vu	IV - 29
49 All Is Not Gold	IV - 32
50 The Illusion of Hope	IV - 35
51 Reagan Vows to Root Out Venality	IV - 37
52 Watergate - and After	IV - 39
53 Wintergreen for President	IV - 44
54 The Times Demand Skeptics	IV - 47

Toward the end of the last century, unable to move representative bodies to accept the changes they needed to modify governmental principles, policies and practices, radicals began cajoling the citizenry into supporting the 'democratic' addition of the initiative, referendum and recall (IRR) to State Constitutions.

Beginning with sparsely populated States, and backed by increasing support in the press, this alien concept moved from receiving strong resistance in 1890, to attaining broadbased support by 1918, when 22 States had adopted one or more of these democratic devices for frustrating the legislative process. More States have done so since, until today there are only a few which have not.

Intended to serve radical causes, and initially used only by radicals, IRR has come full circle, until now it is used increasingly by 'conservatives' to neutralize ever more 'liberal' officials and programs, usually with less than optimum results. Which is no more than could be expected of a democratic intervention.

Only months after 'conservatives' employed the initiative in California, and passed the Jarvis amendment to the Constitution (Proposition 13) to force a more frugal attitude on their officials, the record shows the disastrous nature of IRR as a tool, and of democracy as a means of governing. There has probably never been a more persuasive example of the wisdom of the framers of the legal government of this country, than this test of "participatory democracy".

Dwindling knowledge of the nature of law (and of this government), even by a constituency involved in public issues, makes IRR a dangerous servant. Admittedly, there is little reason for optimism should such a measure be taken to Court. Perversion of the Court from a judicial tribunal to a kangaroo court, creates a climate where the voice of the people can be (and has been) found "unconstitutional". And yet, Proposition 13 was a classic example of the wisdom of the founding fathers in providing representation.

If elective offices had been held by "men almost godlike in their ability to hold the scales of justice with an even hand"\*, Proposition 13 would never have been seen as a necessary addition to the California State Constitution. Such men would be absolutely necessary to carry out the provisions in 13 intended by the people who supported that initiative to protect them from government excesses. Since there are few such men, and even fewer of those in positions of power, it should come as no surprise that 13 was used, both openly and covertly, to destroy representation, and replace it with administrative governance.

The screams of pain from the 'liberals', and the cries of "We're not going to take it anymore", from 'conservatives' died away, as the latter went back to their normal occupations, secure in the passage of 13, and the former discovered the benefits for them which were built into 13. But the abuses perpetrated in the name of 13 set citizen against citizen; citizen against official, and official against citizen, causing chaos and confusion, those essential concomitants of change.

In November, 1978, the Valley Regional Training Center in California issued a Call for a conference to be held the next month at Fresno, to "provide public officials with new ideas and opportunities" to achieve the objective of substate districts under regional umbrella controls (UMJOs). Citing Proposition 13 as the catalyst which the Call stated "compels

change", it cited previous, aborted attempts to "modernize and reform local governments" as "academic keepsakes", for which, it was now admitted, there was no real need, and which brought vociferous opposition wherever it was proposed.

But then the Call proclaimed:

"The passage of Proposition 13, changes all this. More than an illusionary dream of the most visionary of our local practitioners, modernization and reform of local government is now an absolute necessity."

Staffed with a stable of such "visionaries" as the former Mayor of Oakland, John Houlihan (who, as Mayor, called for an end to cities and counties), Roger Anderman, (then-Governor Brown's chief staff person on Government Reform), and Lee Drake, (former Director of 1313s League of California Cities), the Fresno Conference offered attending officials planning expertise, new arguments to use in promoting the "new imperative", the nitty gritty of implementation, and group dynamics to keep the conferees on course in their discussions.

Those who still believe in the tooth fairy might insist that this conference was just another boondoggle at public expense, and that the followup Conference in Sacramento in January 1979 "just happened", but when the legislative package prepared by the League of California Cities began moving through the State Legislature, they might have recognized a systematic series of events, and, perhaps, even the handwriting on the wall. Especially, since that package contained guarantees that there would be "predictable, reliable funding" for all the regionalists' pet projects - and an end to any remnant 'liberal' concern about the mandate of 13.

Although no time was lost initiating the move to "modernize and reform" local government, the "package" still had heavy going, and the it never made it to the Governor's desk.

Near the end of 1987, the powerful Speaker of the California Assembly, Willie Brown, announced that he would lead a crusade for local government reform, as though it were his own idea.

So Willie made headlines again in January, 1990, with a 40-page bill to place all of California under "umbrella multi-jurisdictional organizations (1313s UMOs), a scheme devised in the 70s, promoted nationwide by ACIR, and now, brought out of the closet, brushed off and heralded with the cry of "Modernize!"

So much for the voice of the people! It will continue to be ignored, until the Speaker of the House is one of those voices, and is backed by fifty one percent of the Members who are also representatives. Until that happy day, depend on the Willie Brown's to continue to promote The Dream.

Addendum:

\* Quote from FDR famous "States' Rights" speech, kicking off his presidential campaign against Herbert Hoover - 2 March 1932.

## Political Subversion - 38 - A Vignette of History

In 1976 a small weekly in the Ozarks (American Sunbeam - Seligman, Missouri) reprinted a page of history under the title "The Report of My Death is Greatly Exaggerated". The story was a vignette with continuing value to those interested in knowing the inner workings of the shadowy world which lurks behind the political scene.

The item in The Sunbeam consisted mainly of a letter written to the late, great, Senator William Jenner of Indiana, by the first known victim of a subversion of the political process in America known as "The Purge". There was much more involved than was revealed by the letter though, and this is about "...the REST of the story":

Back in the 20s, an obscure teacher in the public schools in Indiana learned of a Rockefeller Foundation grant which was available for an "innovative" program which would help "bring the schools into the twentieth century". Being an ambitious progressive, the teacher submitted a Plan he had been developing, and it was accepted for funding as a pilot project by the Foundation.

As things turned out, William Wirt's Plan was eventually adopted by all the schools in Gary, Indiana, and by a number of other school systems, even in other States. His effort is still recognized, today, as "The Gary Plan".

What a change it made, in that teacher's life, to have had that opportunity! He received a doctorate and promotions. He was lionized, and asked to lecture on his Plan. His cup was full - until one sunny Sunday afternoon in September, 1933.

Dr. Wirt had gone to Washington, to participate in one of the 'seminars' on education which are routinely held. On that afternoon, he had been invited to the home of Alice Barrows (once his secretary in Gary, but now an official in the Department of Education).

Present, in addition to Dr Wirt and the hostess, were four other officials in the Roosevelt administration, and a seventh person. One of the group was head of the Bureau of Economics in the Agriculture Department; another, an educational expert in the Department of the Interior; the third was editor-in-chief of the publication of the Agriculture Adjustment Administration; and the fourth was a key official in the National Recovery Administration. The seventh person present was "one of the foremost propaganda agents of the Soviet government in America"\*.

From this strange assortment of people, Dr Wirt heard an astounding set of proposals. Apparently the group accepted him as one of their own, for they were not at all reticent about their discussions in his presence. But they misjudged this man.

While Dr Wirt had, indeed, furthered the schemes of the Rockefeller General Education Board as many have done, he did not have any ulterior motive, nor was he, apparently, aware that there was one involved. He was an educator, interested only in what he saw as an opportunity to further public education. And, he was an American.

On that sunny September afternoon he learned that those people at Barrow's house (and others in high position) felt that the United States system of political, social and economic organization was no longer adequate to "ensure the well being of the people" \*\*. In its stead must be erected a planned economy, wherein the everyday activities of the citizenry

would be regimented and controlled by the government functioning through bureaus (just as is now being done by 1313's "Councils of Government").

They thought, Dr Wirt later reported, that remuneration for work, and investment in property, should be under government control, even if the title to the property remained in private hands.

Dr Wirt later charged that these persons (whom he named) were using their positions in the Administration, and their official authority, to change the free enterprise system into a regimented Plan, which would be under federal control.

That day, Dr Wirt learned that it was planned that it should be believed generally that the measures they were instituting in the New Deal were temporary, to facilitate recovery from the depression, but that, in fact, they were furthering the regimented Economic Plan, and their penetration of the government was intended to be permanent.

Shocked and profoundly disturbed, Dr Wirt approached a Congressman he knew, and told him what had been disclosed at that meeting. The Congressman discounted the whole thing. Dr Wirt then went to several other Congressmen, none of whom seemed to accept his tale as truth. He kept on. He wrote a paper on the matter which was widely distributed, and, eventually, he managed to obtain a Committee Hearing of his charges.

All six of the people named by Dr. Wirt denied under oath that they had discussed such matters. The majority of the Committee of five Representatives upheld the accused, but a Minority Report was issued, which held that, not only did the minority find Dr Wirt accurate in those matters in his statement which could be checked, but that they found THE MAJORITY MEMBERS HAD PARTICIPATED in "what was apparently a determined effort to discredit Dr Wirt, and to suppress the truth".\*\*\*

Much, much later, one of the majority members publicly admitted his part in this travesty. It was this Congressman who wrote the letter printed in the Sunbeam.

Congressman John J. O'Connor's was the swing vote in discrediting Dr Wirt, permitting the continuation of the treasonous scheme - a scheme which plagues America today.

In a written statement admitting his part in the conspiracy to discredit Dr Wirt, Congressman O'Connor told his colleagues, and the American people, whose future was jeopardized by his perfidy:

"On the sixth anniversary of the 'purging' of Dr Wirt, before a Congressional Committee, of which I was an active member, I desire to relieve my conscience of a matter which has long burdened it. Dr Wirt had asserted that there was a deliberately conceived plan among the New Deal leftists to OVERTHROW THE ESTABLISHED ORDER, and substitute a planned economy in our country ... Some of his informants had boasted that President Roosevelt would be the Kerensky of the coming revolution ... While he named names, and quoted his informants, I took a leading part as 'prosecutor and inquisitor' ... Little did we know that most of the happenings which Dr Wirt had said the plotters had predicted would come to pass ... Many times, privately, I have apologized for my part in turning the thumbscrews, and I take this occasion to do it publicly.

"May Dr Wirt's honest, patriotic soul rest in peace! His was the voice of one crying in the wilderness..."

Here was a classic case of lack of understanding, which permitted

participation in the plot. What a tragedy for America, as well as for Dr Wirt, that John J. O'Connor did not see fit, sooner, to admit these facts about this criminal conspiracy to deny a fair hearing to Dr Wirt, because HIS vote would have made the majority of the Committee a minority, and Dr Wirt would not have died a broken man - disgraced, discredited, for having tried to warn of the enemy within the citadel of freedom. And the covert, collectivist plan, which could have been checked easily, then, would not have spread its shadows over the length and breadth of America - and every country of the world, as well.

In 1954, Senator William Jenner (R.Ind) made a speech on the Senate floor, which included part of Dr Wirt's story. In that speech, he mentioned John O'Connor, which brought a reply, parts of which are worth including here:

"My dear Senator,

"Two days ago, in the Congressional Record ... you refer to me and as to certain information "Representative O'Connor told us before he died."

"I can assure you that, at latest report, I am very much alive. I am willing to wait on my epitaphs until the turn of the century.

"It was very interesting to me, however, that I could read your fine speech - in which you "speak me fair in death" - on the ramifications of the Communists and their entourage - the fellow travelers, the pinks, the liberals, the radicals, and many of the New Dealers.

\* \* \*

"In May of 1938, as Chairman of the Rules Committee, I, personally, brought onto the Floor ... the Resolution which, when passed, resulted in the creation of the Committee to Investigate Un-American Activities ... such as are going on today from all outposts of the anti-American movement - from the White House down to the Communist cells here and abroad.

"When news got out that I would bring in that Resolution, I was specifically warned by the leaders of certain societies, groups and prominent newspaper heads, that I would live to regret my contemplated action, which would expose certain groups in the United States. In that fall of 1938, I was the sole victim of the "Purge", under the leadership of the President, but actually accomplished - votewise - by turning into my Eastside New York District, all the Communist groups that could be marshalled in New York, and as far west as Chicago, with hundreds of thousands of dollars to purchase the votes. (Despite that) I only lost by a few hundred .

"The drive against me was not due to (that) alone, (nor) to my nationwide radio attacks on "The Menace of Communism". There was also charged against me my leadership in defeating the Plan of the President to "reorganize" the government, with himself as Dictator, and also to my opposition to his Supreme Court packing plan. In his "reorganization bill", he insisted on retaining one provision, to possess the power to change the title of his office as he might see fit.

\* \* \*

"As for Dr William Wirt, your statements in reference to the treatment accorded him are substantially accurate. He became a

like victim, because he exposed the cell of New Deal Communists which conspired in "the little green house on K Street" to make the President "the new Kerensky" of the coming American "revolution".

\* \* \*

Some of us oldtimers, however, who have been carrying on the fight against these Americans turned traitors, feel disheartened at times, at the turn of events, and wonder whether or not the cards have been stacked, and that those patriots who would defend and preserve their country are not about to be smeared to the bottom of the heap, and the subversives land safely on top.

"While I do not know, nor have I ever met, Senator Joseph R. McCarthy, I do know well many of those ... who are leading the mob, bent on lynching the Senator from Wisconsin.

\* \* \*

"Please you, Senator, keep up the good fight.

"Sincerely,

"John J. O'Connor.

And now, you know - the rest of the story of Dr William Wirt and John J. O'Connor.

But the rest of the political story is not yet available, for it is a serial, continuing month after month, year after year. How it will end is up to the American people.

Ultimately, you will be responsible for the outcome, whether you take up the torch lit by Dr Wirt, or whether you do nothing. In either case, it will affect the rest of the story.

Addenda:

\* "Investigation of Certain Statements Made by one Dr. William Wirt", House Calendar 244, Report ± 1439, 73rd Congress, 1934.

\*\* Ibid.

\*\*\* Ibid - Minority Report.

From the beginning, the United States of America have fostered individual liberty. It was planned that way, and guaranteed by the Constitution.

One form of that liberty was freedom for citizens to move to any level their competence allowed - socially, educationally, politically. "Social climbing" was a phenomenon of that. The era of Horatio Alger knew it as "rags to riches". Always it has been recognized as an innate part of the liberties of freemen guaranteed by the Constitution. Regardless of birth, anyone could rise to any heights to which his talents and industry could take him. Nothing in the government stood in the way. To the contrary, the government protected this right.

It was this rebirth of man's inalienable right to direct his own life which held such hope for people in other countries, whose natural gifts were stultified by oppressive laws and customs in their native countries.

There was, of course, the matter of officially acknowledged servitude at the birth of our nation. At that time, slavery was an integral part of many cultures, and not all slaves were black. But that's another story, and it ended here a hundred years ago. No barbed wires, no laws, have prohibited or limited freedom since then, for anyone. Until recently.

Recently, a new breed of "climber" has appeared. This new breed proposes to change this definition of liberty for everyone - but themselves. And they are already well along to their goal.

Wealth, per se, is not that goal. Nor do the new breed look to money to build the ladder to their goal. Theirs is a much more questionable tool. This new breed are ideological demagogues, reaching for the heights from the backs of those who support them financially and who are the intended victims of their ambition.

Their goal is not self-oriented, although there is apparent gratification with each plateau they achieve on the way to that goal.

This "new breed" are the promoters and implementers of the schemes dreamed up by those who people the rarified atmosphere of our shadow government-in-waiting.

While some of the new breed do hold elective office, the great majority are not even in office, and those who work within the government structure are usually in appointive positions. From their seats on local planning boards, as city or county administrators, as appointed department heads, as aides to elected officials, or wherever they can find a spot to use their talents, they look to their confreres in other local government positions; to their counterparts at the State level; to 1313s "professional organizations", and to "volunteers" in the community where they work, for direction, support, and help when needed.

On the State level, the next echelon of the new breed look to an army of ideologues in all kinds of parallel positions in their sphere of operation. They reach out across the nation, to other State governments, to local governments, to regional agencies, to 1313, and to colleges and universities, which are nurturing both schemes and schemers for the future. They find reenforcements in consulting firms, in thinktanks, in the educational community, and even in the private sector, and all of these look to the federal level, and their counterparts there.

Their clones at the federal level have other conceptual affiliates,



including the federal 1313 cells. These, in turn, look to international groups of their breed.

It is, as H. G. Wells once dreamed, an "open conspiracy" of a brotherhood, who may be far apart in life situations, but are siamese clones, in dedication to their Cause.

With such collaboration, and the public purse to finance their schemes, is it any wonder that citizens are met with a solid flank of denial when they attempt to right the wrongs this new breed are perpetrating?

The tax-supported public schools are the incubators for this new breed, and the public and private colleges and universities supply them with the ideology they profess, the techniques they use, and the fellowship of likeminded individuals. Courses in "social engineering"; language as a tool for change; management as a control system, and other esoteric tools of their trade, are daily fare for the new breed, as they matriculate.

Bolstered by the poetic "march to a different drum" theme, they ignore the flak they receive as they break through tried and true legal barriers, in their climb.

Their haughty disregard of citizens and legislators who presume to try to frustrate their purpose, knows no bounds. With support from radical groups of every shade of pink to red, they hold the power of office for elected officials.

Those officials who value the public trust granted them by the electorate, are forced to compromise themselves, fall to this new breed at the ballot box, or face destruction by defamation or legal attacks when they attempt to fulfill their oath of office.

Americans who treasure their liberty can change all this. Only a housecleaning, from the ground up, will stop this new breed. Put none but Americans on guard at the city hall, county center, state legislature, and in Congress, and watch the new breed get old fast!

Do not watch too long, however. There are hundreds of thousands of children at risk - being prepared right now, to join the new breed clan. That is your other job - seeing that these young souls are prepared, instead, for freedom.

Recommended Reading:

"The Open Conspiracy" H. G. Wells, DoubleDay Doran 1926

## POLITICAL SUBVERSION - 40 - Maintaining the Turf

He was an American statesman.

He'd been a member of both Continental Congresses; a signer of the Declaration of Independence; a Member of the first Congress of the United States of America; a United States Commissioner; Governor of his native State; and Vice President of the United States. While his name is immediately recognized today, he is not remembered for any of these illustrious services he performed for his country.

There is evidence to suggest that Elbridge Gerry was a victim of "faction", and not deserving of the opprobrium which has been attached to his name. It may well be that justice would have tagged the partisan evil which his name brings to mind "Danamandering", for his opponent, instead of "Gerrymandering" - but that is really past history, because it is of no moment today.

What was done in that redistricting so long ago in Massachusetts, which added "gerrymander" to our vocabulary, has remained as a horrible example of the evils of faction, ever since.

Until 1981.

1981 was the year California was chosen to be the vanguard in yet another assault on the liberties of American citizens.

Citizens receive short shrift, when professional politicians spin the wheel of fortune. "Human resources" are of value in making the wheels go round, and they are the stake which sweetens the pot in any deal. When it comes to free expression, however, especially at election time, they can be troublesome.

But there are ways to get around dissent, as has been demonstrated in the Soviet Union. The men in the Kremlin have long had the assistance of a secret weapon which guards their precarious powers. That weapon has been known in this country as the Planning, Programming and Budgeting System. Thanks to an unbelievable cover-up, politicians in the United States are being served now by that same mechanism. To be fair, we must admit that most of them probably do not know that this powerful tool is available to them.

To make matters worse, this, the most awesome tool ever devised to assure achievement of a goal is in the hands of those who dream the impossible dream of a managed and controlled world order. That is the decision-making tool which is better known as just "The System", because of the deliberate effort to disguise it by using other names than the one originally given it, once its nature was generally known.

The System moved into the election arena through a Court decision in California, extending a Constitutional provision to all government which was meant to apply only to Congress. In so doing, the Court violated the 9th and 10th amendments, and supplied the opportunity for a pragmatic application of the one-man, one-vote rubric, which perpetuates incumbency.

When the legislators in California attempted to use this tool and to that end issued a request for development of a reapportionment system, the responses from a number of companies in the field were enthusiastic.

From those responses, the about-to-be disenfranchised citizen could have seen the handwriting on the wall, if they but knew about them. Which, of course, they did not.

At least in California, (and perhaps in YOUR state), legislative

reapportionment wheeling and dealing was unsuccessful, as incumbents fought to maintain their own turf, and the hassle was sent back to the Court.

The Courts having long since cast off judicial restraint in favor of ideological advocacy, it was assumed that the determination would certainly favor those incumbents who toed the establishment mark.

While practically nobody believed that the Court would retire to Chambers, and emerge with a reapportionment plan engraved on stone, there was a general feeling that whatever was determined, the decision would benefit the 'liberals' - both those in, and those seeking, office.

What most did not realize was that the Court would have to do exactly what the legislature had done, and turn to "systems specialists", to work out any redistricting. The difference was, that when the Court issued its ukase, there was no room for argument. It had the power to back up its decision.

In view of what politicians did to the Constitutional principle of "equal representation" in California, Massachusetts' 'gerrymander' was a poor fish, indeed. In California, one district was divided, and a portion left on the Coast, with the rest laid out along the foothills of the Sierras!

"Honorable" men and women, elected to conduct the public business, have elected, instead, to conspire to carve up their constituencies for personal gain, and accepted public funds to do it. The scheduled business of government was shunted aside, as irate victims of redistricting struck back at the conniving adepts of upsmanship, and vice versa, by denying each other passage of needed legislation.

"Redistricting" is NOT "reapportionment" within the meaning of the Constitution. The intent of apportionment is clearly stated in that document, and its importance is emphasized by its being placed in the very first section. Its purpose was to assure "equal representation" - nothing more, and, surely, nothing less.

REDISTRICTING, on the other hand, is exactly what that term implies - a changing of districts. Its purpose is manifest. Primarily, it is to "maintain turf" - to assure reelection of incumbents, or to prepare a berth for predetermined occupants of an "elective" office. The other face of that purpose, of course, is to remove, or prevent election of, opposition. None of the above is ethically or morally justifiable. ALL of them pervert and subvert the elective process.

In designing political boundaries, The System is capable of ferreting out every area of support or dissent; of classifying those areas, and placing them where they can do the most good - or the least harm - in terms of the goal.

There is a comparatively limited number of companies with the expertise to program a system for reapportionment. The head of one of the major companies, which had been hired by the California legislature, told them that redistricting was a "task that is inherently, inevitably, explosively, political in nature", and he spoke truly. The Court would, of necessity, have to turn to just such specialists. The 'justices' COULD NOT do it themselves.

The few companies capable of such an undertaking are in great demand, and their experience extends into many facets of American life. One of these was Arthur Young, Company, later involved in the Keating/S. and L. case in California.

A Professor of Law at George Washington University (the fountainhead which masterminded the 5-5-5 Plan for implementing the PPB pilot projects), outlined the need, as a basic requirement in redistricting, for "all

relevant factors which could possibly influence elections". Those factors include, but are not limited to, past voting behavior, party registration, and socio-economic and political profiles of the people in the districts.

By virtue of the comprehensive data now available, the usual constraints of political boundaries can easily be circumvented, in planning future voting patterns. For the same reason, the system supposedly prepared for reapportionment can as easily be reprogrammed to control outcome of ANY election. That capability is present, now.

With the present capability of The System, combined with the "hit lists" of the radical groups which are determined to prevent reelection of incumbents who struggle to hold the line for American principle, it is evident that the growing movement to "reelect nobody" is not a productive way to try to set our Ship of State back on course. It is far more likely to advance the 'liberal' cause, than to open opportunity for Constitutional candidates.

Like so many of the revolutionary thrusts, 'redistricting' benefits are not limited to the surface effect. Because a contract with a private company for design of such a system receives approval of a legitimate government body, that company has access to the numerous 'government' files of every kind of data, including those files kept on individual citizens. This fact provides substantive evidence of the fraud involved in the so-called "right to privacy" legislation or constitutional amendments. Not only is that data unlimited in type, source, and location, but privacy is violated before a citizen could KNOW of it, let alone challenge it.

A private company, such as Arthur Young, Co., with unscreened employees, thus has authority supposedly denied elected officials!

In redistricting, political and census data, public agency records, Dual Independent Map Encoding (DIME), disclosure requirements for public officials, past voting patterns, previous redistricting activity, and other information (data), are encoded in a geographic file, which can be balanced against a desired candidate (or an undesirable incumbent). Resulting data is analyzed, evaluated, cross-referenced to non-homogenous areas of the district to be defined, and the System provides a boundary readout most suited to achieve the goal.

The result is a district which assures that there aren't enough voters to kick out of office those who have proved they don't deserve to be there, or replace them with others, who might rock the boat. This is one more indicator of the impossibility of effective use of the "reelect nobody" movement. Certain seats vital to the NIEO movement are already secured past any hope of successful assault, because there are not enough qualified voters in their districts to topple the incumbents.

Even if the voters in those districts were aware of the real intent of "redistricting", there is little chance that they might get angry enough to throw the rascals out before The System prevents remedial action, since their benefits come from the incumbents, and they are never allowed to forget that. So the major result of the "reelect nobody" campaign must be removal from office of the remnant Constitutional incumbents.

And that is not the least of the problem. The process of redistricting by use of political profiles of the voting public, can not only consolidate supporting areas for a given candidate, it can also isolate pockets of dissent, and make them targets for manipulation, or can neuter them.

By means of the techniques of The System, the data can be organized and evaluated, and then subjected to controls designed to obtain maximum positive response, even from antagonistic voters. Thus, a pocket of 'conservatives' can be isolated in an overwhelmingly 'liberal' district, and effectively neutered.

An identified 'conservative' stronghold can be corralled by cutting a block off a 'liberal' district which can spare it, and redistricting it into the target area. Or, as happened in California, the districts of three staunch 'conservatives' can be redistricted together, thus assuring two lost incumbent seats, and leave only one dissenting voice, where there had been three.

When we first went to the California Legislature with our concerns about The System which could do such things, one Senator told us, "You'll never get support for your position on this matter. There's no emotional appeal." Surely information such as this should rouse violent emotion, considering all that is involved here!

In one way or another, the "campaign reforms" now being promoted or already approved, have tremendous supportive capability in systems subversion of the elective process.

Every citizen should be made aware that this System is now operative. What it can do is no longer speculation. We are now reporting on what is being done with it.

Trying to alert the majority of voters to that fact is an unlikely immediate objective. In lieu of that, every constitutional incumbent should be briefed on these facts, and helped to prepare a campaign which will lead to toward support for a comprehensive set of hearings on the System. Steps should be taken to minimize the possibility of systems-controlled elections in the years ahead.

As of now, a political systems strategy can be circumvented. How much longer that will be true is not determinable. If the "reelect nobody" movement attains its objective, there is a very short-term time frame.

Unless citizens are able to replace the professional wheeler-dealers with representatives, and retain those true Americans now in office, the Soviet "elections" may portend the future for what was once the land of the free.

Chaos and confusion are integral ingredients of the "politics of change", and they are now rampant, in America and worldwide.

Prima facie evidence of "a deliberate, calculated attempt" to bring about changes in our government which are not wanted by the citizens, by creating a "climate for change", was uncovered in California in 1974, in "The Politics of Change" - which we have discussed elsewhere in this book.

Evidence of the intent to usher in a New International Economic Order, by disenfranchising every living soul who is not a participant, collaborator or cooperator in the nefarious scheme, is creating an army of alarmed people, nationwide. Some Americans are seeing the threat hanging over the future of their country for the first time.

All around the country, citizens are rousing from their induced 'apathy', to demand that "something be done" to relieve the conditions being caused by this unprecedented revolution. The problem is, the conditions were designed and created to produce that climate for change, and those to whom the newly alarmed unwittingly turn for help, are often willing agents of the cabal behind it all.

The need for the "loyal opposition" to find their own means of short-circuiting this process, and provide their OWN leadership, is self-evident. The necessity for that leadership to know the political realities is less obvious, but equally vital.

The world has arrived at this state of affairs because those opposed to this scheme have tried to win support from their fellow citizens with logic, truth, argument and persuasion. The problem with that is, the revolutionaries possess that 'secret weapon', which controls the way people think - and react. The situation is comparable to one side possessing the

A- and H- bombs, while the other fights back with foot soldiers, rifles and hand grenades.

By means of systematic management, every existing goal is being altered, and, by the same token, people are being suborned to accept the altered goals.

It is critical that there be an examination of the present situation by every caring individual, and some effective intervention developed, to return the initiative to those who should rightfully wield it.

An area needing immediate attention is the voting booth. Already in a shambles, by virtue of earlier infringements, our lawful political system is threatened by the ultimate usurpation - directed decisions at the polls. With redistricting replacing reapportionment, combined with removal from office of every incumbent Constitutionalist through "reelect nobody" campaigns, the end of any semblance of 'representation' is in sight.

Recommended Reading:

"Democratic Representation: Reapportionment in Law and Politics"  
Robert G. Dixon

## POLITICAL SUBVERSION - 41 -The Strategy of Fraudulence

On the day Ronald Reagan was confirmed as the successor to James Earl Carter by the electoral college, he really blew his cover as a 'conservative'.

The public had swallowed his selection of George Bush to be his vice president. With growing dismay, knowledgeable Americans had received his pronouncements for cabinet posts. But the naming of Alexander Haig as Secretary of State really gave the show away.

It wasn't just the fact that Haig was Establishment; nor the manner in which the announcement was made; nor yet the growing concern about the possibility that reorganization of the State Department (which had been cleared legislatively ten years before but put on ice when it roused an avalanche of protest) was already in the works for the Reagan Administration.

What identified this strategy as fraudulent was the statement in the release naming Haig Secretary of State, that he "enjoyed the confidence of the leaders of other countries". Nothing was said or implied that he enjoyed the confidence of the American people. To the contrary, the release was accompanied by a statement from the Senate Majority leader-to-be, that Haig's appointment could "be pushed through for confirmation" despite objections.

These circumstances underwrite the importance of the need for Americans to be informed about the strategies being used to further the conquest of the world. Americans must know that the "imperial presidency" has no concern for the right of the people to determine their own destiny. It even deliberately withholds knowledge of what is being done in their name. That knowledge is essential in any effort to engage the usurpers in confrontations aimed at restoring the Republic.

Consideration of appointment of any military figure to the State Department is alarming. That Alexander Haig should be selected was ominous. Haig, like Eisenhower, was an obscure military officer, until shortly prior to this move. Like Eisenhower, he was selected out for rapid, unscheduled advances in rank and position. Eisenhower's advancement put him in place to campaign for the executive office. Haig's put him in position for this plum.

To understand why this is important takes more than cursory knowledge of the scenario being played on the world stage.

The charades which accompanied the creation of world war 1 (to "make the world safe for democracy") hid from public view the fact that that stated goal had little to do with the true purpose of that war. The true purpose of our entry into that war had nothing to do with the incidents which 'provoked' our involvement. Official information from that time to the present does not disclose the true intent and purpose of that war. That can only be judged by what resulted from that war.

The result was that the war aligned the American 'government' with the conspiracy to create an international hegemony intended to destroy national sovereignties. That war also began the rearrangement of the world map - a necessary preliminary to the planned control of the world and all its peoples.

America's involvement in world war 2 was needed to further the same scheme. The testimonies of Admirals Kimmel, Short and Theobald concerning

Pearl Harbor were a devastating indictment of the Establishment (which even then had penetrated the Executive Department). The courageous efforts of an American code clerk in Great Britain at the beginning of the second war exposed the trickery which was used to involve us in the European theater.

Creation of the Department of Defense after world war 2 was another phase of this strategy. The National Security Council, another page in the scenario. So, too, was creation of the Disarmament Agency.

In 1970, Jim Townsend, publisher of the "National Educator" editorialized in the January issue of his paper:

"Legislation is pending to merge parts of the Executive branch of the federal government with the United Nations, through an all-powerful cabinet post to be known as the Department of Peace ... The proposed Department of Peace would absorb the Agency for International Development; the Arms Control and Disarmament Agency; the Peace Corps; the International Agricultural Development Service and others ...

"Under the proposed legislation, the functions, powers and duties of the Secretary of State and the Department of State will be transferred to the Department of Peace..."

THIS was the proposal which was introduced in 1970 to reorganize the State Department, and it has never been voted down. It has hung over America like a Damoclean sword ever since. With the appointment of a military officer to State, the thread by which it hangs could be quickly severed. Remembering Haig's brassy assumption of authority after the shooting of Reagan, one may speculate as to how secure that thread is.

A National Peace Academy was part of that legislation, and in August of 1980, Bill Cook, of Liberty National Life Insurance broadcast a report of a 'volunteer' effort to activate the 'Peace Academy'. Quietly, without fanfare, a group called the Commission on Proposals for a Peace Academy had prepared a Report to Congress, urging action.

All of these scenes coalesce in the situation which germinated in California under the stewardship of Ronald Reagan, merging the military with civilian 'peace-keeping' agencies, and the creation of the civil emergency facility at San Luis Obispo.

Actual combat is a fluid situation, and sometimes the game plan has to be changed, for any of a number of reasons. Keep in mind that what is being discussed here is a form of warfare. Haig was confirmed as Secretary, but he did not last long. He was replaced by George Schultz, who began promoting another way to 'peace' - the 'peace' of amalgamation with the world community - notably, the "evil empire".

The Peace Academy is still on the back burner. It is safe to assume that so is the Department of Peace.

Meantime, the Federal Emergency Management Agency continues to prepare for the day when its services will be needed.

Recommended Reading:

"Admiral Kimmel's Story", Husband E. Kimmel - Regnery, 1955

"The Final Secret of Pearl Harbor", Rear Admiral Robert A. Theobald, Devin Adair, 1954

"The Case of Tyler Kent", John Howland Snow LongHouse Publishers



That is a basic question today. In the United States there are several answers, all of vital importance to the future.

One is, when it is not in pursuance of the Constitution - or, if you will, when it is unConstitutional. Another answer is, when it is an order issued by the Executive. This is also unConstitutional, for under the Constitution only legislative bodies can pass 'laws'. Another answer is, when it results from judicial decision. Yet another: when it is a regulation, mandated by an appointed body. No argument here! NOTHING in the Constitution allows for that!

Another question: When is a census not a census? Answer: When the process is used to acquire information from the citizenry other than that required by the Constitution.

It is of no moment which of the above laws or non-laws are used to mandate that additional information be supplied, beyond a simple headcount, as provided in Article I, Section 2, Part 3, of the Constitution of the United States.

NONE of the above 'laws' are valid.

The "enumeration" required by that Section was specifically to ensure that every citizen would be adequately represented in the Congress, by limiting the number of constituents of each congressman, and for no other purpose.

As this country is being guided further and further from its legal base, in defiance of contractual guarantees, the need for information on which to determine social policies grows, and the nature of the information changes. Private decisions, based on the citizens' needs and desires, have always been made by the individual, with only the citizens' own consideration of their personal capabilities and prospects as criteria. When the government usurps those decisions, it must also usurp the facts on which private decisions were made.

Thirty years ago, when the Planning, Programming and Budgeting System was in its infancy, and still under wraps, the ravenous computers were already being programmed to accept the challenge of managing and controlling the lives and actions of every citizen from the cradle to the grave. It was then that the first serious federal grab for nationwide centralization of information was made by issuing the extended census.

At that time, only an insignificant number of citizens were faced with such questions as how many bedrooms there were in their homes, how many baths, how many to use them, and an extensive list of equally prying questions.

That 'limited' census was conducted for any of a number of reasons. It prepared the citizenry for acceptance of the "extended census", gave the bureaucrats a practice run on collection of information; and began preparation of the citizens to accept eventual total 'government' coverage of their personal lives.

Of prime importance, that census supplied a broad-based sampling of the data needed to do the trial runs on the social programs even then being prepared for an unsuspecting public. It gave impetus, too, to the movement for a central "data bank" to be ready for the operative System, intended to change our representative Republic into a socialized, totally managed and controlled, administrative governance.

It is reasonable to assume that all of the preliminaries are now complete, and the time has come when the Planners are ready to "leave the hard issues of physical planning and policy, for the soft shoulders of social policy."\* The major legislation for a managed and controlled society has become law; the data banks are in place; the programmers and analysts are trained and hired, and all that is needed now is creation of "a climate for change", the current data, and one more piece of legislation, to put it all together.

That final piece of legislation was intended to be the integrated Bill called "The Public Works and Economic Development Act of 1979". It was about to come out of Committee, expected to be approved by both Houses, and signed by the Executive, when Senator Alan Simpson (R, WY) initiated a floor fight against its Title V.

Senator Simpson stated that if Congress were to pass that bill (S 835) as written, it would "declare the American system of government null and void, abolish the states, and establish a new political mishmash". One apparent result of Senator Simpson's opposition was activation of the "climate of chaos", and a strategy which has been successfully used over and over was brought into play.

S 835 was passed in the form of an amendment to another bill (S 914), and was sent to the House for agreement, but wasn't acted on before a recess adjournment. When Congress reconvened, the S 835 companion House bill, HR 2063, was sent to the Senate, debated, amended and passed. The two bills were then sent to a joint committee, for resolution. There the record becomes obfuscated. Whether Title V remained in the bill as finally passed is unclear. That bill was a masterful example of the use of language to disguise a purpose.

Trying to obtain a true history of the PWEDA as it exists in the statutes is next to impossible. The evidence suggests that Title V has been approved, whether at that time, or later, as an amendment to some other bill, but the substance of it is clearly being implemented.

There has been no Constitutional challenge to the palpably unConstitutional provisions of that Title. If the people supinely permit that to continue, and accept the unConstitutional 'census', obediently bowing under the outrageous invasion of their privacy which both represent, the time will indeed come when Big Brother takes over, as the Planners work their will with "consent" from the people's 'representatives'.

No need to write your congressperson on this one. Congress has already spoken on both issues. It is directly in YOUR hands. Disguised, true. But for the first time, the people are being asked - no, TOLD - to vote directly for Big Brother and his control of their lives. Penalties are provided if that "consent" is not given.

You want it, you answer all those questions, and meekly give Him what he needs to make the control work.

You don't want it, you read the Fourth Amendment to the Constitution, and let your conscience be your guide.

As for me, give me liberty...

Addenda:

\* Quote: political scientist Victor Jones, quondam collaborator on Roosevelt's National Resources Planning Board; sometime professor at UC Berkeley; and "expert" advisor to the ACIR. From his testimony to ACIR on 'local government reform', 1973. (ACIR Hearings on Substate Districting Volume A 43a)

POLITICAL SUBVERSION - 43 - None Shall Escape

There is a tale (which may be apochryphal) of a clergyman in Germany, who, when asked later for an accounting of his nonresistance to the Nazis, is quoted as having said, in effect, that

"First, they came for the Jews, and I wasn't a Jew, so I did nothing. Then they came for the Catholics, and I wasn't a Catholic, so I did nothing. Then they came for the enemies of the State, and I wasn't one of those, so I did nothing. When they came for me, there was no one left to do anything to help."

Every occupant of a seat in Congress today would do well to ponder the implications of those remarks, apochryphal or not. Even Jim Wright, but recently two heartbeats away from the Oval Office, could have benefitted from this information.

Wright was in the Congress on the 19th of April, 1972, when a Member rose on a point of personal privilege, and carefully documented a story of harassment against him, which stemmed from the performance of his duties as a Congressman. The incidents had taken place over a period of seven years, and were sequential, as his recital definitely showed. If his colleagues heard his remarks, there is no evidence of it in the Congressional Record for that day, nor in the days which followed.

That Congressman was Cornelius Gallagher (D., N.J.), Chairman of the House Select Subcommittee on Privacy. It was at Gallagher's instigation that the first hearings were held on the use of the polygraph as a tool of control. The information elicited from those hearings demonstrated the need for continuing such examinations of methods being introduced by 'government' to obtain data previously considered outside the realm of government's "need to know". And so, the continuing Select Committee was created to oversee such proposals.

Hearings into psychological testing, and its erosion of the Bill of Rights resulted, and they were followed, in logical succession by hearings on the proposed Federal Data Bank, and its threat to individual liberty; on the files maintained by credit bureaus, and their use by federal agencies; and on the drugging of children in the government schools.

In the spring, the Subcommittee was fighting for its life, to continue investigation (already begun) into behavioral modification as a method of control. Despite an unprecedented demand from the public for this investigation, Congress defeated the funding for the Subcommittee by a vote of 216 to 168.

By April of that year, the harassment of Congressman Gallagher had reached a point where rumors and reports were being published which not only reflected adversely on his character and integrity, but, if true, could possibly have been grounds for criminal indictment. Instead, the 'government' brought in trumped up charges of tax evasion; his District was apportioned out of existence; he was defeated in the primary by his own Party - and, eventually, was sent to a Federal prison.

Before all that 'happened', though, this courageous man took that time of personal privilege, to inform his colleagues of his travails.

Like most Americans, until he, himself, was caught in its political arm, Cornelius Gallagher had been a supporter of the FBI. There is no

question, from the record, but that it WAS the FBI which initiated and encouraged the harassment of this gallant fighter for individual liberty, any more than there was in the matter of ABSCAM. Who instigated the moves against Gallagher - or those later victims - is not proven.

When none of his colleagues rose to support him in his darkest hour, Congressman Gallagher continued, alone, to press for action to neutralize the capability of the FBI to intimidate Members of Congress - or citizens - who might be inclined to resist the forced march into a managed and controlled society. For he was convinced, and with cause, that the purpose of his harassment was to force him to drop his investigations.

On introducing the Bill which he hoped would limit the powers of the FBI, Gallagher pointed out that

"...when I told the facts of my blackmail by the FBI to responsible Members of the House while it was happening, back in 1966 and 1967, each responded as if I were a leper, asking to hold his hand..."

Gallagher was certainly a victim of reverse serendipity, for, on the first of May, 1972, just after he had introduced his Bill to investigate, J. Edgar Hoover was found dead on the floor beside his bed. It was not the best of times to obtain an objective look at the FBI!

In his remarks on that anniversary of another patriot's more famous warning of enemy attack, this modern Paul Revere tried to warn his colleagues that it wasn't just Cornelius Gallagher who was in jeopardy, but each of them, as well, or any citizen of these United States. He pointed to the cases of Senators Long, Brewster, Fong and Tydings; Congressmen Dowdy, McCormack and Boggs. He could have named O'Connor, McCarthy, Dies, Thomas, et al. But he warned against the dangers to anyone in "standing up to the elite", from "faceless men who intimidate us, precisely because what happened to me can happen to anyone."

At least two Congressmen, then his colleagues, who did nothing, later faced similar charges under ABSCAM. Were they, too, treated as lepers by their colleagues?

The list of victims of this inquisition steadily grows longer.

Will Congress ever take a look at the "surveillance subculture, and the police state mentality" which, by its very existence, intimidates, and silences opposition?

"No man escapes, when freedom fails.

"The best men rot in filthy jails,

"And those who cry, "Appease, appease,"

"Are hanged by those they tried to please."

- Author unknown.

If "uneasy the head that wears a crown", consider the plight of those who serve the "royal cause". Not only are they in constant jeopardy from the "peasants", just for implementing royal edicts; they must also beware the displeasure of their "liege", should they fail to satisfactorily fulfill his commands.

For over a quarter century, the Congressman from Ohio had served the "cause" of the powers behind the government of these United States, protected and promoted for his service. Imagine, then, his inner turmoil on Sunday, the 23rd of May, 1976, when he found that, after all those years, he, too, was expendable.

What did he do, to fall from grace? Could it have been the reversal of his position on the Atlantic Union Convention? Perhaps. For Wayne Hays did not vote alone, and that was the year that passage was scheduled for that long-sought major step into a world hegemony. Instead, although there were more sponsors than ever, the margin of loss on the final vote was greater than the last time, by sixteen votes.

Whatever the reason for his immediate problems, Hays, himself, apparently did not know for sure, at least in the beginning. His disbelief that it was 'happening' was evident in his desperate efforts to ward off disaster.

His speech on the floor of Congress on the Tuesday after the Sunday headlines in the "Washington Post"; the hurried conferences with the "best lawyers in the House", and one of the best "in town"; the quick trip back to The District to demonstrate the confidence "his people" had in him; then his pathetic appearance before the Ethics Committee at his own request, when he finally realized he could not stop the steamroller. He was obviously trying to salvage something for the future. All these actions speak of his inability to understand the attack on him.

Wayne Hays was not the worst Congressman Washington had known. He was, rather, typical in many ways of the pragmatic politician who "goes along to get along". Now that he has gone to his final reward, the real reason for the orchestrated attack on him may never be publicly known, but it was transparently not because of his personal conduct. Such conduct is only too frequent in the vicinity of our nation's Capitol. To learn that Mr Hays did not spend his spare time studying official business would not surprise Members of the Ethics Committee. Their debates on the various election reform acts disclose a sure awareness of human frailty. Even the possibility that the other charge (of using the public purse to finance his private pleasures) might prove valid, is not THAT big a deal in today's "post-Constitutional" political world.

Those who place themselves at the call of the Establishment soon learn to sublimate whatever ethical standards they take to Washington, in the interest of the "supermorality" which allows the "end to justify the means". Given that climate, it's a short step from official blindness to personal blindness.

It is not clear just when Wayne Hays became an Establishment man. Obviously, he had done yeoman's service for them over the years. Perhaps his most important contribution came in the early 50s, when he was assigned to the Reese Committee, which was charged with examining the influence of tax-exempt Foundations on American life. His willingness must have been known before that, however, for he went on the Reese Committee with a blank

check from Congressional Democrats, and a boasted support from the Republican White House. Certainly, neither side of the aisle saw fit to blow the whistle on his antics in Committee, which were "calculated" to cripple the investigation of misuse of tax-exempt funds.

Although at the time of the Hearings into the Foundations, Establishment newspapers were avidly engaged in the destruction of Senator Joe McCarthy and seeking an end to his courageous battle with internal subversion, they found front page space to laud the Gentleman from Ohio for his successful effort to stymie the Reese Committee, and frustrate its purpose. The very papers which detailed the peccadillos of this same Gentleman in 1976, were then flashing stop-the-press bulletins about his "heroic effort to inject some sanity and fairness" into the Hearings which threatened continuation of Foundation support for Establishment causes!

The degree of Mr Hays' "sanity and fairness" at that time is clearly shown in the Committee prints of the Hearings, which are still available in many State libraries.

Members of the Ethics Committee were kinder to Mr Hays than HE was to the witnesses before the Reese Committee. Perhaps they remembered Shakespeare's warning, "Treat every man after his own deserts, and who shall 'scape whipping?", and considered their own futures.

The Gentleman from Ohio sounded like an echo of the Gentleman from New Jersey in his remarks to the House, after the news broke:

"...any Member of this House, or of the other body, is wide open to anyone who wants to make malicious statements..."

Unfortunately, that is true, if they stand in the way of Establishment goals, whether or not they have ever served the Establishment.

POLITICAL SUBVERSION - 45 - Whose Ox is Gored?

It makes a difference. It has come on gradually over the years, but there is now an established pattern which demonstrates that Orwell was right. In the land of Big Brother, some ARE more equal than others.

As the highly paid minions of the Establishment Press bored in on the candidate for second place on the Republican ticket for 1988, it would have been nice if just one voice were heard saying "it seems to me I've heard that song before". None was, so please let me remind you:

\* Once there was a Resident of the White House who appointed a crony to high office, who then accepted a vicuna coat as a "gift". The ensuing uproar from the Newshounds was something to behold.

\* Once there was a Resident who was guilty of nepotism, appointing his brother to high office. Did you expect, maybe, a ten on the scale of outrage? What you got was a zero minus.

\* Some recent Residents have had extra-marital assignments while occupying the White House, even bringing assignees into its hallowed halls. The Press was privy to these illicit affairs at the time but not a word was spoken or printed about them.

\* Then there was one who hoped to live in the White House, who took a cruise with a woman who was not his wife. Is any reminder needed as to what was done to him?

\* Once there was a Resident whose close friend and appointee was involved in payola. The national Newspersons were surprisingly circumspect in reporting that.

\* Another Resident (never a favorite of the media) was hounded out of the White House (and most of his staff with him), over a political fluff no worse than some of which he, himself, had been a victim. The Press had treated the incidents when he was the victim as pecadillos. This time, they led the pack in baying at his heels.

\* Yet another Resident had a close personal friend who was accused of using his friendship with The Man to obtain governmental favors for a private venture into a ski resort. Again the Press led the way in the vendetta. Does anyone remember now that a Congressional investigation cleared this man?

This list, of course, is incomplete, for the strategy is not only comprehensive, it is unending.

But we must take a more penetrating look at Bert Lance, abused friend and appointee of another Resident, for cause.

Oh, yes, he did resign. But the point here is how this affair was handled by the Press. No panting after the man who appointed him. No daily hammering for details. The Press was almost apologetic in reporting the allegations against him; with great delicacy withheld comment on the staunch support he received from Jimmy Who.

More than equal time was given Lance to explain away the charges being made. Senator Thomas Eagleton (D.Mo., who knows something about the power of the press in destruction of a public image) jumped into the fracas, and was featured extensively on the 'news', as he tried to prevent what he apparently believed was an inquisition as unjust as his own. Unfortunately, the Lance affair was something quite different than the

Eagleton affair.

Not only were there shadowy dealings (slighted in the Press coverage), such as questions involving the Carter peanut empire which had a touch of quid pro quo, but there were substantive questions involving the Rockefeller interests.

The nature of the office to which Lance was appointed also had relevance.

That office now holds the key to the power of the Executive Office. No longer the Office of the Budget, as the Press continued to refer to it, its importance was infinitely magnified, when it was redesigned and renamed the "Office of Management and Budget" (with the accent on management). With that alteration, the position of Director demanded a very special kind of official to fill its chair. One with the very qualities of the man who resigned from it under a cloud. There couldn't have been a better choice for that seat than Bert Lance, considering the requirements of that Office.

The Office of Management and Budget (OMB) is the heart and soul of the Planning, Programming and Budgeting System, which has been installed secretly in every element of our government. Its purpose is to manage and control every facet of American life - political, social, ethnic, religious, legal, economic - everything. And OMB is where it all comes together, to be orchestrated into harmony by the single head which the PPB requires.

Such a position requires that the Chief Executive Officer possess the very qualities which Lance had demonstrated, both in his prior experience and in his response to the exposure of alleged misconduct. His facility for bluff would serve well the needs of the PPBS - for bluff has been the hallmark of PPB from the beginning. Bluff has been the major attribute of the promoters and procurers of The System.

Lance's financial acumen was also well-suited to the process of budgeting for control purposes. His obvious capability for manipulation made him a natural for the job.

Why then, the charges brought against him?

Perhaps the real question should be "Whose ox was being gored?" Was it really Lance - or the man who appointed him? Is it possible that the mixed signals from the Establishment media resulted from a substitute target? Could it be possible that Carter's loyalty to his cronies from Georgia interfered with his allegiance to the Elitists who created the opportunity for him to sit in the Oval Office? Could the power of the Presidency have befogged his view of his duties? Could it be that Lance was really a fall guy, simply because he was so qualified for that job that his removal would provide a message Carter could not ignore?

Did this fine tuning so confuse the Press that they didn't really know whose ox was being gored?

Recommended Reading:

"It Didn't Start with Watergate", Victor Lasky, Dial Press, 1977



POLITICAL SUBVERSION - 46 - On the Job Training

When the man with the red phone on his desk, and the button at his command, is as ignorant of the purposes and capabilities of the heads of state with whom he must deal, as Jimmy Carter admittedly was, one realizes the enormity of the clear and present danger facing this country and the world.

If he really didn't know the nature of communism, as he related in the debate with his opponent, where in the name of commonsense was he, when the Senate and the House set up special Committees, which, painstakingly, thoroughly and intensely investigated Soviet aims and activities, back in the fifties? If he really didn't know, why was he not briefed before the campaign, so he could intelligently discuss foreign affairs? Reams of hard facts about communist intent, method, practices, tactics and strategies, had been published by Congress, for the record and for public consumption.

Soviet goals and techniques have not changed from the beginning. ANYONE who aspires to public office has a duty to know the nature of our legal government, as well as the nature of any threat, existing or potential, to it.

William C. Bullitt (no 'conservative', he), first U.S. Ambassador to the Soviet Union, gave devastating testimony about the nature of communism. He told of a top Soviet official who bragged to him of his part in directing the first Soviet takeover of another country.

In 1919, GPU agents were sent into the target country (Outer Mongolia), to prepare the way for it to become the first Soviet satellite. Agitation, propaganda, and infiltration of the police and army, made the coup d'etat a "very small affair", he said. The official told Bullitt:

"After all, in a country of nomads, there are only about 300 or 400 people that count, and all I did, on a given night, was to have about 400 people seized by GPU agents in the army and police forces, and I had them shot before dawn, and installed the people that the Soviet government wished to have installed..."

As it was in Mongolia, so it was in Albania, Armenia, Austria, Byelorussia, Bulgaria, Estonia, Georgia, Hungary, Latvia, Lithuania, Poland, Ukraine, Yugoslavia. Except that, in the cases of the European satellites, the crimes were committed with either the tacit consent, or active support, of the United States.

"Operation Keelhaul" will ever be the ultimate in governmental depravity. For a government "conceived in liberty" to aid and abet enslavement of people born free, is surely more heinous than for a dictator to rise from within a nation and enslave his fellow nationals. When the Supreme Commander of the forces in Europe at the end of world war 2 received the order to repatriate all nationals in Free Europe to their country of origin, he had to know that most of them were being sent to certain death - after almost certain torture and depredation.

Why did Eisenhower not protest that order? Why was the order given in the first place?

Americans are not permitted to forget the 'holocaust' of Hitler's Germany. From the past, hear the voices of witnesses to other holocausts

in the countries in the way of Soviet expansionism, as described in some of those Congressional Reports:

ARMENIA:

"...Communists (here) were almost negligible. a few instructors at the Religious seminary...a sprinkling of professors...some misguided students, and a few railroad workers...Communism was totally alien...to the Armenian people."

A secret meeting was held by those few communists in 1920, where the tactics to achieve the 'revolution' were decided upon:

"After (the Soviets) took over Armenia,... the former members of the government were thrown into prisons, where the slaughtering ... was started."

BULGARIA:

After the deadly combination of aggression and camouflaged coup d'etat, so-called "people's courts" were set up, and:

"...almost every prominent Bulgarian politician, officer, civil servant, judge, teacher, journalist, businessman..." was sentenced. 2,580 were exterminated.

BYELORUSSIA:

In 1930 - 31, mass arrests of the Byelorussians were staged. All were condemned, sent to concentration camps, and all perished.

GEORGIA:

In a democratic election in 1920, the communists didn't get a single vote. So 'democratic process' was by-passed, and an attempt at armed takeover was severely defeated by the citizens, so open aggression was discarded. Then subversive strategies were activated:

"...literally thousands of their agents penetrated Georgia, agitating and staging riots..."

In 1921, the goal was attained in Georgia, by deceit, subversion, treaty violation, and rioting:

"...the Russian reign of terror began... members of the government and the legislative body (fled)... over 7000 Georgians (were) executed."

Between 1921 and 1941, more than 60,000 were killed in Georgia.

LITHUANIA

The horrors in Lithuania were too numerous to recount here.

UKRAINE:

"It was the usual custom of the bolsheviks not to take prisoners ... All who were taken were shot on the spot ... At

least five thousand people had been executed within a period of five days..."

Even Jimmy Carter should recall the anguish of Hungary. As the world witnessed the agony of the "students" in the People's Republic of China in 1989, how many Americans remembered that the same horrors were visited on the Hungarian 'students' who rebelled against their tyrannous masters - and recorded on TV for the world to witness?

Each country named above - and all the rest of the Soviet block nations - suffered the same inhuman, vicious fate as these, just as has been witnessed in Afghanistan recently, and which now threatens Lithuania again - and Latvia and Estonia as well.

Carter's ridiculous "ultimatum" to the Soviets to clean up their act or we would not permit the Olympics to be held here, was worse than useless. It was obscene. Argument about whether or not the Olympics should be held is trivial and diversionary and demonstrates the callousness of those in this country who cooperate in manipulation of world politics. The truth is, that, even as Carter spoke, another Soviet-directed mass extermination was taking place, in view of the whole world - and nothing was done by the administration here - nor any one else, except the target people - to stop it! So what could be expected from George Bush, in reaction to the massacre of the 'students' in China? Or from his Secretary of State, who showed his irritation when reporters stopped him on his way to lunch to ask how the United States would respond to the execution of three of the 'student' leaders?

Supporters of the UN might well ask themselves why that peacekeeping organization isn't keeping peace.

It was of no significance that the Soviets withdrew from Afghanistan. The bloodbath was over by the time they did, and Afghanistan will never be the same.

The Presidency of the United States is no place for on-the-job training. These horrendous aggressions by the Soviets are but intermediate objectives to their stated goal - world conquest.

America needs representatives who know what's been going on, who are dedicated to stopping these murderous mattoids, and who can force redirection of administration policy.

Such representation would obtain the support of the American people - and most of the world - to do whatever is necessary to put an end to the "Soviet threat".

Recommended Research:

House Report No. 2684, 83rd Congress, Parts numbered 1 through 17, 1953,4.

"The Soviet Empire - Prisonhouse of Nations and Races", Senate Internal Security Committee, Doc. 122, 85th Congress, 1958

The hyped propaganda all but obscured the installation of the fortieth Resident of the White House. Bumping regularly scheduled programs for longwinded spiels about the off again, on again, travails of 52 American citizens, whose lives were violently disrupted in the wake of the Iranian revolution, the purveyors of prepared pap bleated conflicting stories of the imminent release of the 'hostages', hour after long hour, night and day.

Lacking any substantive information, the personalities who pass for reporters these days, spent expensive airtime quoting each other; interviewing various minor government officials; and, at one point, the lame duck from Plains, who delivered a non-earth-shattering announcement of no substance; and otherwise used the airwaves to prepare the public for the obviously staged 'release'.

The media blitz served to prevent reasoned consideration of the consequences which could be expected from this incident, and to evaluate ways to avoid future confrontations such as this.

As was the case in the Cuban "tractors for hostages" exchange twenty years earlier, the exorbitant demand made by the terrorists had piddled down from the original figure to one about half as exorbitant, and the final figure seemed almost conservative, as a result.

Not once in all the hoopla was there any mention that this was not an unusual act of barbarism, let alone that it was a continuing strategy eating away at the American stature in world affairs. Not, that is, until Captain Bucher managed to break through the prepared script to plead that the 'hostages' not be put through the "debriefing" planned for them (as he and his men had been), was there any mention of former humiliations visited on this country by third rate little enclaves. What effect Captain Bucher's plea had on returning those victims to their families immediately on return was not made clear.

Although it was inevitable that reference to the Pueblo would follow as a result of Bucher's surfacing, other equally degrading circumstances, which have brought the once-great United States contempt from other civilized countries, and sorrow and shame to its citizens, were given no chance of exposure.

The horror of Operation Keelhaul was left in the crypt of history. The shame of the rejection of the cries for help from the freedom fighters in Hungary; the disgraceful rout in China, leaving American men in prison camps there; the years of enslavement and torture afforded American servicemen taken prisoner in the Korean action; the blackmail by the bearded barbarian of Cuba, which was called, among other things, "Tractors for Ransom", but dwindled down to government pressure on private pharmaceutical companies to supply the ransom in their products instead, as a "humanitarian" gesture; the dishonor accompanying the U-2 incident; the attack on the Liberty; the loss of face, when the U.S. was not allowed to win in Korea; the servicemen still left in the hands of the North Korean communists, and the brutality they have suffered (physical and mental); the reprise of Korea in Vietnam; the uncounted nationals of those southeast Asian countries, who looked to the United States to rescue them, but, instead met torture and murder - none of these entered the discussions about the return of the Iranian hostages.

But they should have, for these 'incidents' are part of a continuing plan to reduce the influence and stature of the United States of America to a level which will permit its amalgamation into a 'peaceful' world - a cityless, countryless world, under the control of the most conscienceless band of scofflaws that world has ever known. Their power grows with each additional humiliation visited on America.

Of course, there wasn't a whisper, in all those tedious hours of hype, of the fact that the top officials of this country knew (or had reason to know) before the Shah of Iran was brought here for treatment, that, if he was allowed entry, the embassy would be invaded, and American citizens threatened. No 'reporter' asked why the staff wasn't evacuated, too, when other Americans were. No one asked why the entering of the embassy was not regarded as an act of war, since American soil was invaded. No one questioned calling the staff "hostages", instead of "prisoners of war" which was historically correct. No one suggested that the so-called "rescue attempt" was really an act of war, and properly so. No one asked why such a paltry, obviously doomed, attempt at rescue was made by the best military force in the world.

Nor was the matter ever brought before Congress, and an ultimatum delivered to Iran.

It was yet to be determined whether the changing of the guard in Washington would result in a return to the standard raised by the Founding Fathers of this country, as the people so patently expected.

The charges being leveled in 1988 that the Reagan team made a compact with the criminals holding those hostages had not surfaced at the time, but if true, it suggests that the changing of the guard in Washington did not result in a return to the standard raised by the founding fathers of this country, as the people so patently expected, when they voted for Ronald Reagan.

There must be an open investigation of those charges. If they are valid, it would go a long way toward showing the degradation of the mind of an administration which would permit the development of the arms/Contra scandal.

It was the standard which earned the United States the respect it received through so many years, that Americans longed to see restored. It was that standard which, for all those years, protected American citizens wherever they traveled around the globe.

Lest it be forgotten, it was that standard which was the major factor in achieving the greatest strides toward true civilization the world has known. Its erosion is permitting unimagined evils to now threaten ever greater indignities to be visited on this nation and its people.

Degradation is the essential element in conquest through psychopolitical strategies.

And nothing was done by the Reagan Administration to modify the world view of America created by this unbelievable record of shameful incidents. Rather, that image was reenforced by the surfacing of information of the activities of top Reagan officials in the so-called "Iran/Contra" affair.

#### Addendum:

It was the original of this chapter which triggered the cancellation of my column by the Valley Times. The new owners of that weekly paper used the phrase "purveyors of prepared pap" as the offending element which caused the cancellation. No mention was made of the substantive information contained in the article.

Watching George Bush stand on the podium in Atlanta, espousing the planks of the Republican Platform of 1988, and fervently expressing his support of the treasured precepts of American political philosophy, brought a sense of having experienced it all before.

My memory took me back eight years, and I was watching Ronald Reagan stand on the Republican Platform of 1980, fervently expounding his support of the treasured precepts of American political philosophy.

Suddenly, I was stepping back in time to the 1932 presidential campaign, and hearing once more the dulcet tones of Franklin Roosevelt, as he supported the 'conservative' Democratic Platform of that year.

It is natural to want to believe that these men meant what they were saying. The future of the world may well hang on the truth or falsity of their words. Yet there is little in history to recommend such trust. With the exception of the honorable men who were the first to serve in the Office of the President - statesmen who made a living document out of the Constitution by their adherence to its principles as they created the machinery of government which it directed - there have been too many in that Office who have not been bound by their word - or the "chains of the Constitution".

Americans desperately wanted to accept the apparent sincerity of Ronald Reagan in 1980, just as the assurance Roosevelt offered in 1932 was needed then, and the hope that the ringing speech Bush gave in Atlanta was sincere was desperately needed. But the spurious nature of Roosevelt's promises was not long in surfacing. Shadows of his past belied Reagan's promises, and realistically portended a similar disillusionment. Bush has been Establishment throughout his career, which does not bode well as far as his words are concerned.

It was not Reagan's record as Governor of California alone, which warned of betrayal of the philosophy he so eloquently enunciated, when he would become the occupant of the White House. His choice of Bush as his running mate sounded a tocsin to those familiar with Insider politics. The close advisors Reagan chose; his selections for the Secretaries he appointed; the philosophical bent of his Women's Advisory Council - all were portents of the future.

If there was one thing above the others, which exposed Reagan as a "counterfeit candidate", it was surely the commercial he used in the 1980 campaign, which purported to be a clip of the former Governor signing a tax reform measure, which was actually the signing of the most liberal abortion bill passed in any State.

The evil men do does live after them, but Ronald Wilson Reagan is haunted by his past, while yet he lives. He rode to the Statehouse in California on the strength of "The Speech", in which he castigated the forces destroying America - unelected bureaucrats making decisions which were rightfully the duty of elected officials. Yet, one of his first acts as Governor was to appoint a mammoth group of "experts" to make just such decisions - a Commission for whom the people had not voted, and over whom they had no control. Later, he appointed another such Commission, to do for the schools what the first did for the State.

His Office, over which he DID have control, participated in producing the most heinous document of any put out by 'government' which this writer

has seen. "The Politics of Change in Local Government Reform", was a basic text in mass mind control. Reagan was given an opportunity to refute it, and did not.

Reagan personally initiated and led the massive attempt to replace local elected government with "substate redistricting" - a euphemism for installing regional machinery throughout the State. He reorganized the Governor's Office to accommodate the regional superstructure and the management and control system required to regulate the regional authority. That reorganization became the pilot model for other States to follow.

As governor, Reagan caused the reorganizing of the licensing department into the massive bureaucracy known today as the Department of Consumer Affairs. He reorganized an auxiliary of the Department of Finance into another superagency, a teeming bureaucracy now called the Office of Planning and Research (OPR). The former California Council on Intergovernmental Relations (CCIR), which became a target for citizen resistance because of its radical programs, was quietly folded into the vast recesses of OPR, where its nefarious activities could no longer be monitored and protested. Submerging of the CIR was triggered by exposure of the Reagan/Houlihan program for creating "The Politics of Change" textbook (TPOC).

Even before his election in California, Candidate Reagan supported the oppressive 1313 Constitution Revisions. Many Californians voted for those revisions, because they believed Ronald Reagan was a conservative, and therefore, the revisions must be all right, or he wouldn't support them. Proposition A, far from being the boon Reagan represented it to be, was a necessary preliminary to centralization, and the socialization which accelerated with his election.

One of the first bills he signed after taking the oath of office approved the infamous "sex education" program in the schools. His appointments to the State Board of Education were predominantly 'liberal'. His most conservative appointee to the State School Board resigned in protest against the Reagan policy of "making the Board a rubber stamp for progressive socialism" (quote from Clay Mitchell's letter of resignation).

Not only did Reagan not resist the federal Omnibus Crime Control Act of 1968, he encouraged full implementation of its oppressive provisions. The California Council on Criminal Justice (CCCJ) became the prototype for other States to install the most dangerous tampering with the system of jurisprudence ever witnessed in a supposedly free country. The CCCJ mushroomed into the most expensive and expansive bureaucracy in the State - until it was surpassed by the control center known as OPR.

The programs CCCJ instituted ranged from promotion of gun control (which Reagan says he opposes), to the incredible "Early Intervention and Prevention Program" (EIPP), which presumes to determine which infants will grow up to be criminals, and which encouraged development of strategies to divert California's children into planned and programmed paths, as their catalogued profiles identified their potential.

Threatened by widespread and vocal adverse citizen reaction, the CCCJ was allowed to quietly expire, but not before Reagan had prepared a substitute bureaucracy to replace it. (This same strategy was later used to bypass massive opposition to the Federal Regional Councils under his Washington Administration.) Without fanfare, he had created yet another unelected body, the Select Committee on Law Enforcement Problems (SCLEP), to "identify, analyze, and examine" another course of action for criminal justice.

While citizens were still storming the CCCJ meetings, the SCLEP was already developing the future of "law enforcement", and not just for California. Programs instituted there frequently become models for other States to emulate, and this one can be demonstrated to have been a prototype - not just for the other States, but for the federal structure as well.

It was Reagan's SCLEP which originated the State Office of Criminal Justice Planning (OCJP), and prepared the way for the "prestigious" Commission on Project Safer California and the Public Safety Agency, which, again, served as pilots for other States. This tampering with the so-called justice system, also spawned the indoctrination center for 'peace officers' at San Luis Obispo, which grew into the machinery for implementing the Federal Emergency Management Agency (FEMA). The program in the Civil Emergency Management Course at that Center began the merging of all "peace-keeping forces", including the military. (See TID/VIII - "The Authoritarian State"). That program has supplied troops nationwide, who are prepared physically and mentally to overcome "insurgents" who might attempt to resist the de facto government which is replacing the de jure government of the United States of America.

When Reagan went to Washington, he took with him Louis Guiffrida, director of the training camp at CSTI - the California Specialized Training Institute at San Luis Obispo, and made him head of FEMA.

This (necessarily) limited list of the duplicities of the Reagan record is offered in sorrow, and without malice, as an attempt to prepare Americans for the future, whatever it brings. Unless the citizenry recognize that, when it comes to candidates for the Executive Office of whatever Party, "the conservatives get the rhetoric and the liberals get the action", the helix of disillusionment will inevitably result in a diminishing of citizen participation in the election process, to the detriment of the Republic.

The restoration of Constitutional government lies in the representative offices - not in the administration. It is to those contests for seats in local, state and federal offices which are responsible to those who elect them, that the people must apply their energies, their time, their money, and their concerns.

The promises candidates make to obtain executive offices, even granting sincerity, require legislation to be implemented. And only representative offices can lawfully supply that.



POLITICAL SUBVERSION - 49 - All Is Not Gold

There is a fearful tendency among Americans to ascribe to others their own values and standards, and to accept 'goodwill' as automatically as the air they breathe.

While "innocent until proven guilty" is a precious part of our heritage, it simply isn't valid in a battle situation. When there is good and sufficient reason to accept that war has been declared on the legal institutions, and to recognize that open attack is being waged, it is foolhardy to trust the enemy to abide by rules which apply in peacetime. Anything goes in war, for it is the most foul activity in which mankind indulges.

In this war, the revolutionary goal is victory over all mankind - by 'peaceful means' if possible, by force and violence, when necessary.

It is a truism that war is an extension of politics, or "politics by other means", but, in this war, the customary pursuits of traditional politics are but incidental aspects of the over-all battle plan.

The visible moves in this war are being waged mainly in what is usually thought of as the political arena, although not in the sense of partisanship, but they also rage through every field of human endeavor. The two major Parties have been used as a sort of "special forces" in this country, and supporters of both have been, in the main, unwitting collaborators. It would be perilous to ascribe to the Party leaders, however, anything less than knowledgeable cooperation, and it would be far safer to consider them willing participants, unless they prove themselves otherwise.

The covert tactics are not easily identified, but they constitute the most dastardly assault ever launched against a targetted population.

It should always be kept in mind that war is not conducted on a moral base. It is immoral by its nature. The goals of war are ever those which cannot be attained by moral means. What is taking place today is a worldwide revolution. Not recognizing - or not accepting - that fact forces decision on less than total understanding.

It is impossible to argue the merits of an issue which does not rely on its true substance, but is, in fact, a tactic or strategy of war. When confronted with an enemy objective, one cannot relate to it effectively, without first determining whether or not it is a redoubt in enemy strategy.

Valuable time is wasted in debates over whether a specific program is good or bad, or what its level of priority should be, when the real issue is whether or not it is supporting the enemy's goal.

The same is true of individuals. 'Conservative' and 'liberal' as definitions of a philosophy are one thing; as code words in revolutionary jargon, they are something else. Then, they become triggers of conflict, and tools for 'change'.

As a case in point, consider former California Governor Ronald Wilson Reagan, probably the most highly regarded 'conservative' to attain stature on the national scene. He spoke out on all the issues dear to Americans, and said exactly the things they long to hear from a leader. But what did he do to deserve their trust, other than making eloquent speeches?

Ronald Reagan was publicly a 'liberal' Democrat until the early 60s, even while he began making The Speech which identified him as a

'conservative'. He was still listed on the letterhead of the World Federalists in 1961, but he crisscrossed the country, making The Speech over and over, and Americans, starved for a political figure with which they could identify, took Ronald Reagan into their hearts.

True conservatives in California practically forced him to run for the governorship. But what happened, after the election?

Let a CBS newscaster tell it like it was:

"...he came into that election carrying the image of Barry Goldwater. He emerged at the end of the campaign bearing the image of Nelson Rockefeller..."

It was in the former IMAGE that Reagan governed the State of California, but it was with the PROGRAMS of the latter. So true is this, that, when he ran for the second term as governor, he had to rely on the wiles of the Rockefeller people and the Hollywood "ratpack" to support him. California conservatives sat that one out.

Regionalism never made more progress than under the guidance and support of Ronald Reagan. Even Rockefeller was not able to construct the first complete regional governance crossing state lines scheduled for his State of New York and New Jersey, but Reagan pushed for, and obtained, finalization of the Tahoe Regional Area Plan (TRAP), eroding the California/Nevada state line.

In The Speech, Reagan told of "an invisible government", run by "people for whom we have never voted, for whom we will never vote, and whom we cannot recall by our vote", which, he truly said, would "lead to the most oppressive tyranny". He was right - and he proved it, when he became governor, and secret government became the order of the day.

As Governor of California, Reagan served on the Federal Advisory Commission on Intergovernmental Relations (ACIR), the beachhead of the regional forces within the federal executive office, until pressure from the citizenry made him resign. Under him, the California CIR, the State arm of ACIR, rushed headlong into regional activities. When its plans bogged down in citizen resistance, the CIR, in conjunction with the Governor's office and a thinktank in Berkeley, prepared a policy paper which called for the use of sophisticated techniques to control mass opinion, including the use of "change agents" to direct the thinking of the citizenry. (See TID/III - 11 TPOC)

The California legislature did not know, when the Governor gave them two bills with an urgency clause, that those bills were going to open the door to a totally controlled and managed society, and they were passed in a record three weeks time, with but one dissenting vote. Some of the legislators never knew that those bills were the enabling legislation for the Planning, Programming and Budgeting System.

Four pages of documented Reagan activity supported the largest volunteer Republican group in California, when they repudiated a Reagan bid for the Presidency in 1976.\*

As for being a fiscal conservative, Reagan's State Budgets give the lie to that. His first budget, shared with the former 'liberal' governor, was for \$6.5 billion dollars. The next budget was all Reagan's, and it was \$7.5 billion. The next was \$8.8 billion, the next, \$9.85 billion. In 1970, Reagan's reorganization turned the State over to the nefarious, experimental Planning, Programming and Budgeting System (PPBS), and the following budgets take an expert to read, since they are programmed

budgets, but they continued to skyrocket.

This report is not intended to castigate Reagan, but is, rather, presented as probably the most obvious example of the fact that all that glitters is not gold. Nothing - and no one - can be accepted at face value, in a nation and world at war.

In their hearts, Americans long for an end to hostilities, and some dream of a man on a white horse, who will make the nightmare vanish. It will never be like that. When this war is won, and the enemy routed, it will be because enough Americans cared enough for each to carry his own assigned duty to fulfillment.

That duty is assigned to each individual by God at birth, and, in this nation, by the laws of the land.

Nothing less than that will suffice. Nothing more is needed.

Addenda:

'revolution' = "A radical change in...governmental conditions; the overthrow of an established political system, generally accompanied by far-reaching social changes" (Prerevolutionary dictionary)

'peaceful means' = conquest by assent, through deceit; misinformation; disinformation; cheating; trickery; entrapment; creating confusion, chaos and a climate for 'change'

Recommended Reading:

\*UROC Resolution. (qv)

To one degree or another, most Americans are now aware of a control exercised over the mass media. Despite that, there appears to be little acceptance of the effect the doctored 'news' has on the thinking of the general public - themselves. Even those who know enough about current events to be resistant to the manipulation of information do not appear to realize what effect that manipulation can have on the individual decision-making process.

No one is immune to the planned assault on the mind, regardless of the depth or breadth of one's search for truth. Even recognition of "overt" thrusts at obtaining credence for whatever premise is currently being promoted is no protection from "covert" or subliminal suggestion.

The mystique of 'conservatism' is constantly being reenforced in the media by both overt and covert methods. Nowhere is this more evident than in relation to the quadrennial contest to select "the man who" will occupy the White House for the ensuing four years. One candidate is identified as 'conservative' (whether he is or not), the other as 'liberal' (whether he is or not). It is on that base that Americans are asked to decide who gets the nod.

Those of us who monitored the political career of Ronald Reagan in California, are constantly amazed at the general acceptance of his reported 'conservatism', by those who could be expected to have a more jaundiced eye in judging his performance. If those who have more than a surface knowledge of the political scene can accept his public image - what can be expected from those whose only knowledge of the man is derived from what HE says, and what the MEDIA says about him?

These thoughts gained additional pertinence, as George Bush stood on the podium in Atlanta in 1988, and gave a most credible performance of a 'conservative' seeking the votes of the great body of Americans who really are conservative.

This is not a new strategy. It has worked well in the past. The election of Franklin Delano Roosevelt in 1932 was a textbook example. The elections of Ronald Reagan in California, and his 1980 national campaign and election are classic.

In the Foreword to "The Roosevelt Myth", John T. Flynn, a political analyst who knew firsthand the essence of both 'liberalism' and 'conservatism', wrote of:

"an image projected on the popular mind, which came to be known as Franklin Roosevelt. It is the author's conviction that this image did not at all correspond with the man himself."

Flynn went on to demonstrate from the record that the public view of FDR was created by "highly intelligent propaganda, aided by some illusions, enlarged and elaborated out of all reason..."

As just one example of that illusion, this writer (like most Americans), never knew, during all the Roosevelt years, that he could not walk. Some there were who apparently believed, as a result of the propaganda, that he could do it on water.

Flynn's description of the Roosevelt image could as well be applied to Ronald Reagan. This is demonstrated in two books researched and written by

Kent Steffgen, a California political analyst. The first, "Here's the Rest of Him", is a report on Reagan's first year in the Governor's Office. The second, "The Counterfeit Candidate", was written in 1976, and carefully documents the Reagan record over the eight years he occupied that Office.

These two slim volumes constitute devastating proof of the Reagan "illusion" created, accepted and promoted by the media.

The mythogenesis of Ronald Reagan is without parallel. Even Roosevelt was unable to invade the public consciousness as Reagan has. Of course, there was a much larger segment of the media still outside the Establishment orbit then. It is no myth, however, that Reagan opened the backdoor to socialism both in California, and in Washington, while orating from the front balcony on Americanist principles.

It is also no myth that only those who cannot face up to the reality of what Reagan did in office still refuse to come to grips with his record. While understandable, this bodes ill for the future.

Ronald Reagan was one of the most charming people in or out of politics - or in that other world of make-believe through which he passed on his way to history. He was personable, handsome, and a great actor. That he never became a star in Movieland is surely not due to any flaw in his acting ability. Proof of that ability lies in the performance he gave without let, from the time he announced his candidacy for Governor of California.

He became the number one top banana on the political scene, surpassing the previous holder of that title by a comfortable margin.

Give Roosevelt credit. Once his actions belied his words, he shrugged off pretense and stood foursquare behind the programs he spearheaded. Not Ronald Reagan. HE shrugged off the reality of his actions with a supreme ability to dissemble. With his well-modulated voice, his winning and disarming half-smile, and his aptitude for the bon mot, Reagan could face the cameras publicly condemning the evils of programs he, himself, slipped through elected representative bodies, or quietly promulgated as Executive Orders.

Those citizens who remember what the media did to Barry Goldwater in 1964, and who accepted Reagan's vaunted 'conservatism', might be well advised to ask themselves why the Great Communicator did not receive the same treatment Goldwater did. They might be surprised to find the answer has to be that Goldwater was sincerely conservative. He meant what he said, and, in their hearts, Americans knew he was right. That he made mistakes only proves his fallibility as a human being. Reagan's record in office exposes his true place on the political spectrum.

Reagan was, as Steffgen identified him, "The Counterfeit Candidate".

Recommended Reading:

"The Roosevelt Myth", John T. Flynn, Devin Adair, 1951

POLITICAL SUBVERSION - 51 - Reagan Vows to Root Out Venality

At the end of the first hundred days of the incumbency of Ronald Reagan in the administrative office of the President of the United States of America, the content of the Federal Register (FR - repository for executive action) during that period required three and a half feet of shelving to contain his daily output, standing on end, back to front to back. (This was by far the most extensive use of the FR we have seen. Most FRs are less than 1/4 of an inch thick.) In these Registers were all the new rules and regulations instituted by the administration, and all the Executive Orders (EOs) Reagan had issued since he assumed office.

An AP dispatch dated 26 March, 1981, heralded one of those Orders. The title of this chapter (above) was the headline on the AP story. The EO in question was # 12301.

In announcing the creation of yet another bureaucracy, Reagan's script used all the appealing rhetoric he so ably delivers to capture the support of the people for a new assault on "government waste and fraud". Then he proclaimed:

"The American people are demanding action - and they are going to get it... We are going to follow every lead, root out every incompetent, and prosecute any crook we find who's cheating the people."

And so was born the President's Council on Integrity and Efficiency.

There is a legitimate concern involved in the question of "efficiency" in government. After all, Mussolini's fascist regime made the trains run on time! But, surely, "integrity" is something else.

Several problems are immediately evident as regards a committee directed to rekindle "integrity" in government agencies, which, by their nature, are antithetic to the moral principles which that word connotes. The immediate problem is self-evident. "Integrity" is a personal quality, and if the holder of an office does not have it, no horde of "watchdogs" can supply it. Not generally recognized is the fact that appointed committees are not generally restricted by the requirement of taking an oath to support and defend the lawful government.

Sometime back, the Congress had moved in the direction taken in this EO, by providing legality for a corps of "Inspectors General" (IGs), supposedly to police the internal affairs of the overgrown Ship of State.

In response to the Congressional edict, Jimmy Carter appointed sixteen IGs, each to oversee a specific department of the federal government. Reagan, in office, fired all of Jimmy's sixteen, but then he created this Council, and rehired five of them, appointed one new hand, and sought ten more to go on the payroll. (The one "new" hand was Alexander Haig's 'political advisor', when Haig was Supreme Commander of NATO.)

This Council, and its IGs, were to develop a "coordinated, government-wide" attack on fraud and waste in government programs. Since most government programs today are fraudulent in concept, and wasteful by nature, that was a tall order.

On the surface it appeared that the Council, as a federal body, would be involved in federal matters only. It would be a grievous error to accept that to be the case. There are few federal programs today which

don't interlock with State and/or local governments, so ANY "government-wide" attack must impact on areas expressly denied to the Federal government by Article Ten of the Bill of Rights. Section 2(b) of EO 12301 actually points this out!

The Council was directed to develop a corps of "well trained and highly skilled auditors and investigators", and to create programs and projects to deal effectively with "problems which exceed the capacity or jurisdiction of an individual agency".

If anyone fleetingly thought of the Declaration of Independence, Reagan's Council should have roused some resistance to "creating a multitude of new offices, and sending swarms of officers to harass our people and eat out their substance", but that did not happen.

The Chairman appointed to this Council was a Deputy Director of the Office of Management and Budget (OMB), that venal seat of the infamous Planning, Programming and Budgeting System (PPBS). The person named by Reagan to be Chairman of the Council was one Edwin Harper. Despite a serious effort, it has not been possible to confirm or disprove whether or not this is the same Edwin Harper who diligently served Reagan in California, in the implementation of the PPB there. It would seem implausible that there would be two Edwin Harpers with a competence in management and control great enough to merit such authoritative positions, and both serving Reagan, but it could be.

The PPBS is a fraudulent program, deceitfully implemented. If the Reagan Administration wanted to "wipe out venality" in government, there could be no better place to start than with this System, and the agents who brought it into our government.

There is a tape existing of a meeting of the California Commission on Educational Management and Evaluation, one of the PPB implementing agencies there, on which California's Edwin Harper, as director of the project, expressed the hope that the work they were doing would be "kept low-key, in terms of talking about it, or holding hearings". The clear implication of his remarks verified what citizens had already discovered - that implementation of the PPBS was known, by those involved in adapting it to the management of society, to be unacceptable to the public. These agents had to know that The System had to be sub rosa, demonstrating a clear lack of integrity.

Wouldn't it be something, if such a person as California's Edwin Harper were appointed integrity czar for the entire country?

In announcing Reagan's "assault on venality", Press Secretary James Brady described it as "the unspoken fifth leg of his (Reagan's) economic program", and said that the Inspectors General would be "meaner than junk yard dogs".

In view of the record that Reagan had turned the State of California around to serve the purposes of the PPBS; that he personally endorsed the bills which legalized the System under the rubric of "data processing"; that he urged their passage as "emergency measures"; and that his tenancy of the Governor's Office there was marked by full implementation of the System in California, as well as tremendous advances of peripheral projects, the likelihood of this - or any other Council he might appoint - rooting out the real source of corruption and venality would seem remote, indeed.

But that's the way it was, three years before 1984.

No one has ever satisfactorily answered the question, "Why Watergate?"  
It was such a stupid act.  
Or was it?

The basic premise described in Chapter 11 of this book applies to just such situations as Watergate. That premise is essential to understanding, and ability to counter, current and future moves which endanger Constitutional principles. The premise: if a situation doesn't "make sense" from a usual point of view, it should be examined using other postulates, to determine whether there is a rational position from which it DOES "make sense".

Watergate is such a case.

Here were available the most skilled operatives in the world, with the power of the greatest executive office of the greatest nation in the world, and the most efficient management system in the world, supposedly behind them.

Yet these "experts" bungled a simple burglary, which any two-bit habitual criminal could have performed blindfolded.

Our home was burglarized by a drug addict, and it was done more skillfully than that. I didn't even know it had been entered, until I started to get supper, and missed the coffeepot, the electric fryer... the kitchen clock...

How could Watergate "happen"?

Customary explanations fade, or become as ridiculous as those accepted without question by the mass media, that the burglary at the Watergate was just a stupid, clumsy act.

Examine, then, the possibilities further from normal patterns:

\* Suppose, in the interest of obtaining a solution, there were a group of persons who wished to eliminate the government of the United States of America. Accept, to make this point, that some of them were in high positions inside that government - positions of trust.

\* Suppose this group had access to the most powerful tool for decision-making in the world - the Planning, Programming and Budgeting System - with its central control in the Executive Office of Management and Budget.

\* Suppose that tool were used to determine the most likely route to accomplish their desires.

\* Suppose the readout indicated just such an attack on the presidency as Watergate could have been (and indeed, turned out to be).

Then consider again- "Why Watergate?"

When you explore this line of thinking, you are faced with a wholly new premise. Watergate was NOT bungled. It did precisely what it was intended to do.

To be aware only of what has been repeated endlessly by the mass news media, is to miss the real significance of Watergate, and the events which unfolded AFTER that 'incident'.

The central, overweening issue of Watergate and its aftermath is the overt destruction of the forms of our government. Watergate was only an incident in that destruction.

The creation of "the imperial Presidency" provided a climate in which such cloak and dagger schemes as The Burglary could occur.



The televised "hearings" on the proposed impeachment of Richard Nixon did nothing to remedy the situation.

What follows is NOT a defense of Nixon. It has been a long time since a Constitutionalist such as your scribe could find a rationale to support him. Despite that, those who accept Richard Milhaus Nixon as the supposed 'master mind' of Watergate miss the essence of the tragedy of Watergate, which is not Mr. Nixon's, but that of the nation, itself, and all of its citizens.

Although some of this destruction is assuredly covert, for the most part it is being done openly and with a wrap of virtue, by people in both elective and appointive positions, financed to a great degree by the public purse, and with the assistance of a subservient Press.

In a less troubled time, Mr Nixon, himself, described this as "the New American Revolution", and participated actively as a leader in it. It may be that he is still participating even after Watergate.

While much remains to be said about the break-in at the Watergate, it is toward the attempt to impeach that attention should be directed, for it was there that the chipping away at the foundation of our governmental system took place.

Without enforcement of the basic human rights recognized in our Declaration of Independence, and guaranteed by our Constitution, tyranny becomes the order of the day. It is "to secure these rights (that) governments are instituted".

After Watergate, tyranny became a reality.

Our legal system is based on presumption of innocence, and nowhere in the records of that system can it be found that the man in the White House is denied that presumption.

The fact that some - notably Congressmen - were willing to waive Mr Nixon's right to this presumption of innocence might, perhaps, not be of too much importance. Except that SOME of those Congressmen were about to sit as "judges" on a bill of impeachment, and the "newshounds" quoted and requoted these hitlerian disciples, until their OPINIONS assumed the stature of FACT. Many citizens were as upset about Mr Nixon's "guilt" as those congressmen were complacent about it.

Another basic premise of our juridical system is the right to remain silent, when accused. Need it be pointed out that the constant hounding of Mr Nixon made this right seem wrong, when he tried to avail himself of this protection?

Closely allied to that right is the right not to be compelled to testify against oneself. This is germane to the issue of the tapes, which Mr Nixon was forced to submit to the Committee, even before determination that he must go to trial.

Which brings us to yet another violation of American jurisprudence - the right to an impartial trial. Surely, this includes an impartial Grand Jury, which is the closest comparison to the function assigned to the House Judiciary Committee. The bias of the majority of that Committee was clearly exposed during the disclosure stage of Watergate. A number of Members openly expressed their belief that Nixon was guilty, before they received any evidence. The specious nature of some of the charges pressed in the Committee debates underscored that bias.

All which brings us to a sober reflection:

If the man in the Oval Office can be subjected to such abuse, without protest except from his partisans, what protection can the average citizen expect, in like circumstances?

If it were the least among us who received such treatment, how safe would the rest of us be?

NO ONE escapes, when freedom fails.

Not only was the House Judiciary Committee clearly overweighted with "prejudice" (in its original meaning of 'prejudgement') in advance of evidence, in the matter of preparing a bill of impeachment, but no concern was heard from any of its Members over a strange legal precedent which had been established.

The fact that the responsibility to initiate such action, which is rightly vested in the House, was preempted by the Senate Select Committee Hearings, was completely ignored. "Sole power to impeach" is the charge to the House by the Constitution. Thus, quietly, another portion of the basic law of the land was broken.

Senators, who would sit as a jury, should the House vote impeachment, had already received evidence, which would certainly color their judgement, if a bill of impeachment came before them. That "evidence" included hearsay, and other matters which are not admissible in any court trial. Repeated denials that Nixon was a "defendant" in the Senate proceedings seemed a moot point, as the questioning of witnesses constantly led to the possibility of presidential involvement.

In considering the damages which the aftermath of Watergate inflicted on our historic form of government, it is important also to consider the matter of the 25th Amendment to the Constitution. While the 25th was legally adopted, it must be asked how many of our citizens knew about it, when it was being considered? How many, even now, could say what it adds to the Constitution? Most important, how many knew what its effect would be on our form of government, when a situation arose where the ultimate effect of its use occurred?

That ultimate use became operative, when Richard Nixon was forced to leave the White House.

Passed under the supposition of 'presidential disability', this Amendment provided for the appointment of a vice president, should a vacancy occur in that office (as resulted from the resignation of Spiro Agnew). When Richard Nixon left for San Clemente, the appointed vice president took over the Office of the President.

In view of the extreme pressures for appointive government officials, one must wonder about this conveniently prepared provision for the Office of the President to be occupied by an appointee. When that occurred, those devotees of appointive government achieved their crowning success - an appointed "President"!

Unlikely as it is that it could be believed that such destruction as resulted from Watergate and the subsequent attacks on Richard Nixon were planned that way, there is another piece of evidence which makes even a stronger case. That evidence lies in the fact that the attacks on Nixon followed a technique which was perfected a quarter century ago, and have been polished by use since then.

Then, as in the Watergate matter, the original charges faded, as they were found to be without solid basis.

Then, as this case, the mass media pounded away at the contrived issues.

Then, as with Watergate, NEW charges were made, based on reaction to the original charges.

Then, the cry was, "Give us the names!"

After Watergate it was "Give us the tapes!"

Some who were leaders in the attack all those years ago were leaders in the attack on Nixon.

Then, as in Watergate, it was more than a man which was the target.

Then, it was a concept which had to be destroyed.

In Watergate, it was the very Office of the President.

Make no mistake about it: the hue and cry over "The Burglary" held the potential to destroy, not only the man who held that office, but the office, itself.

What happened when Richard Nixon stepped down from the Presidency was precisely what had been disclosed as the intent of some Members of the House Judiciary Committee, in the final hours of the impeachment hearings.

From statements made by Members of the Judiciary Committee in the last hours of the "hearings", it was clear that the intended impeachment of Richard Nixon was also intended to restructure the whole relationship of the executive to the other, until now coequal, branches of government.

The Senators actually discussed redefining the functions of the executive, through the language used in the articles of impeachment!

The structure of the Executive was redefined when Gerald Ford took the oath. He recognized it himself, in his first remarks to the citizens after he took office. The President is no longer the representative at the federal level, of all the people. He does not, in fact, represent any of the people. Who DOES he represent?

In the matter of Gerald Ford, he represented Richard Nixon, who appointed him to the vice presidency. But Ford was not accountable to Nixon. He represented the House and the Senate, who confirmed his appointment. If he was accountable to them, it was a violation of the intent of the Constitution, which provides for three separate, distinct, COEQUAL bodies. He might be considered accountable to those who devised the 25th Amendment to the Constitution. At the time that amendment was passed, there were rumors that it was the brainchild of Nelson Rockefeller. He certainly promoted it. If Ford was accountable to him, he might have been accountable to his own appointment to the vice presidency!

These are serious suggestions, which deserve serious consideration. But there is at least one other.

Early in 1973, an eminent (and consistently accurate) columnist, Paul Scott, reported a scenario being whispered about in influential circles in Capitol City - even before Spiro Who was forced to resign. The whispers had Richard Nixon forced out of office, and succeeded by the vice president, who would then appoint Nelson Rockefeller in second place. This country would then have that appointed president, and an appointed vice president. It's certain sure, that, with Nelson just a heartbeat away, a Gerald Ford would not be indispensable.

So what do you know! Nixon WAS forced out of office, and guess what! The appointed vice president DID replace him, and what do you know! He DID name the former governor of New York as his "heir apparent". Coincidence? Perhaps. It is, however a matter of such serious import, that it MUST be thoroughly explored, and proven either true or false. Either way, it directly affects the future of this nation.

Surely, the American people will not sit idle, when they know that officials elected to serve them, and to "protect and defend" their government, themselves serve such a cause as this, and in full view of the nation!

Surely, the American spirit of fairplay should have demanded for Richard Nixon the same justice every American has a right to demand - and

receive - himself, even if now it must be done retroactively

It is vital now that there be enough red-blooded Americans elected to serve in the Congress of the United States to take back the initiative from those whose motives are necessarily suspect, and correct this damage, without fear, favor, OR prejudice so that "this nation, under God, shall have a new birth of freedom, and shall ... not vanish from this earth."

That Congress must be mandated by the people they represent, to investigate thoroughly, without fear or favor, the facts or the fiction contained in the questions raised here.

The scenario played out in the 1988 campaigns visavis the selection of Dan Quayle as v.p.candidate suggests that there may yet be another exercise for the 25th. It would be the better part of wisdom to close off that possibility, before it would materialize.

#### FOOTNOTE TO THE STRATEGY OF DESTRUCTION OF CAREER POLITICIANS:

It is passing strange that only Joe McCarthy tried to raise the question of causative factors, when the administration then in office turned on him. That unanswered question haunts the political scene today.

WHY would a powerful "President" or Speaker of the House not try to protect his place in history by revealing the "men and forces at work" whose Goal requires such destruction?

POLITICAL SUBVERSION - 53 - Wintergreen for President

In August, 1980, Republicans gathered in Detroit for the quadrennial farce of apparently selecting someone to carry their banner to the White House. Shortly after, the Democrats had the ingathering of their Party faithful for the same purpose. How many of those in attendance at the Convention Hall or the Joe Louis Arena knew that the fight was fixed is a moot point.

An unconscionable number of Americans seem blissfully unaware of the fact that they have no voice in selecting "the man who" will occupy 1600 Pennsylvania Avenue, "The man who" has already been chosen before the roll call, and the citizenry has been manipulated to accept that choice by the time caucusses and primaries are held.

With the possible exception of Calvin Coolidge, who got there by a fluke, no one since Woodrow Wilson has put his hand on the Bible and sworn the Presidential oath, who has not been tapped by the cabal which, today, all but rules the world.

At first, the "divide and conquer" technique was enough to assure election of the chosen "man who". When Teddy Roosevelt "bolted" the Republican Party, assuring the defeat of an elected President, and the victory of the first Puppet President of the internationalists, the strategy achieved the election of Woodrow Wilson. Wilson was the first candidate, too, to use the "promise them anything, but give them the Plan" strategy.

The restless natives are kept in check through the hoopla attending conventions, and the ruse of providing the appearance of a "choice".

To a person who treasures his United States citizenship as a priceless heritage to be jealously guarded, the constant erosion of his government has much the same effect as the Chinese water treatment. He lives in the hope of someone coming to the fore with the formula to avoid the strings of the puppetmasters, and still get elected.

With each additional incursion, some of the hope of such a citizen erodes. It is most disheartening, when a candidate comes forward, who seems to hold a promise of doing that, and is defeated. Most disheartening - except, perhaps, when such a candidate gets elected, but then, safely in office, assists in the erosion.

Either way, the Planners win.

Thus, in 1952, Americans supported a charismatic General, whose long public career seemed to give assurance that, as President, he could lead the way back to the Republic. But he was defeated by an equally charismatic General, who charmed more voters, and then took a path in the opposite direction.

It was 1960, before there was another chance. Richard Milhaus Nixon, who had built his reputation on his exposure of the records of Helen Gahagan Douglas and Alger Hiss, seemed to many voters to hold the promise they longed for. But his campaign was sidetracked, and the loss was the greater, because the margin of defeat was so slim, and Nixon refused to challenge the count, in the face of widespread evidence of fraud.

In 1962, Californians had a real opportunity to elect a Governor. The radical incumbent seemed a lost cause, since he faced a stalwart opponent - a State Senator with a proven record of Americanism. But somehow the challenger lost, and the ranks of activists who had worked their hearts out

for Joe Shell, thinned again.

Grown men wept on that election night.

Then it was 1964. The hope once more centered on Washington, and a choice not an echo. The heartbreak following that defeat was devastating. When the smoke cleared, large contingents of Goldwater supporters joined the legions of non-voters.

1966, and Ronald Wilson Reagan rode into the Statehouse in California through the cheers of the old-line, dedicated workhorses who had lived for that day. These were the patriotic faithful, whose efforts were augmented that year by a whole coterie of neophytes, wakened to the urgent need for a return to the Republic, by ProAmerican rallies, and anti-communist "schools".

How sweet that victory seemed! But the people who had been Reagan's support in that campaign were not part of his 'team' when patronage was handed out, and the only noticeable difference in the government was the speed with which the Plan advanced under his administration.

I was one of those 'workhorses', having been Precinct Chairman for the Central Committee in El Dorado County. For the first time, after that resounding victory, I went to a Republican Women's Convention with high hopes that there were enough of us now, to make a difference in the incoming administration. How naive I still was, then!

Our guest of honor was our newly elected Republican Governor. Traditionally, the victorious candidate circulated through the room, thanking his supporters, shaking hands, exchanging greetings. Not this time. Our Candidate was a noshow until time for the Dinner. As we drifted into the dining room, to vie for places near the head table, we were nonplussed to find the half dozen tables around the podium roped off. Word was passed around that this was for 'security' purposes.

When our candidate arrived, he and Mrs Reagan were surrounded by security people, and marched directly to their places, acknowledging the tumultuous welcome by arms raised in the victory salute. What a put down! Our new Governor and his consort were to be protected from the women who had put them at that head table!

As things turned out, it might well be that that was precisely the case. Not from any threat of bodily harm - but the danger that existed if we were allowed to discuss our hopes for his administration directly with him.

We had had a "test run" of this strategy at the State convention before the election, when all Club Presidents and Precinct Chairmen were photographed with the candidate for publicity stills. It seemed strange at the time, the way that was done. It was summer, and HOT. All of those to be shot with the candidate were herded into a room together right after lunch, to wait a turn with the photographer.

One corner of the room was hidden by a heavy drape, and in that corner the camera was set up. As each County was called, the two officers went behind the curtain, to be photographed with the candidate. They were given no notice to freshen up, comb hair or mop off the glow. I don't know about the others, but I had a message for the candidate on a paper in my tight little fist.

I never got to give it to him. He wasn't there when we went behind the drape. We were positioned for the lights and the camera, and told to hold it. A door opened behind us, the candidate slipped into place, the camera blinked, and the candidate was back through the door, before I even realized it was over, let alone remembered the note.

In 1968, Nixon finally made it to the White House, and it was Reagan all over again, on a national scale. "The conservatives got the rhetoric, and the liberals got the jobs."

1970, and Reagan had to call in the Hollywood "ratpack" to make it back to Sacramento, and, again, more patriots opted out.

And then it was 1980, and disillusioned Californians tried to warn the nation that Reagan was not what he seemed. While they didn't know the scenario to be used, those who monitored what he had done in California knew that, insofar as Ronald Wilson Reagan was concerned, there was no possibility that he would posit any problems to the "Insiders", once he was inside the White House, nor offer any hope of a return to the original goals for America, for the rest of us.

Only representatives, chosen by the people, from among themselves, replacing politicians who, if they are not Insiders, at best are cooperators, can make the change Americans want.

Wintergreen, Nixon, Carter, Reagan cannot.

Neither can George Bush.

The almost hypnotic acceptance of Ronald Wilson Reagan as the epitome of the leader needed to guide this country back to the Republic has always been concerning, when the way he performed in the Governor's office in California is taken into account. With George Bush picking up on the Reagan record in Washington, it is downright disquieting.

There is an overweening need for a healthy skepticism in considering George Bush and his place in history, for his past activities equal Reagan's, in contravening the policies they both enunciate for public consumption.

As soon as the 1980 election was assured, preparations began for The Reagan administration. It should be remembered that the changing of the guard in Washington was heralded by the most intensive and extensive "transition" activity ever witnessed in this country. It was patently intended to underline his campaign promises, and to raise even higher the hope that his administration would lead the country back to a balanced norm.

Reagan's proposed "Economic Renewal Plan" received a massive public relations treatment. Possessing the merit the propaganda ascribed to it, such assiduous application of adroit pressures for acceptance would not have been necessary. Given the extraordinary popular support for Reagan's candidacy, any truly meritorious program he offered would have surely found irresistible enthusiasm demanding its passage. Congress would have HAD to respond in favor of vox populi.

The inevitable question, again, is "WHY?" Why this Madison Avenue hype, for something which Reagan, himself, said the people wanted? Come, let us reason.

Even before the debris from the inaugural had been swept away, agents of the new administration began a major lobbying and sales effort for Reagan's 'plan'. (Let's not quibble over whether or not it was Reagan's - it WAS a Plan.) There was plenty of evidence that the major part of the "transition" activity was designed to develop strategies and tactics to assure acceptance of the Plan.

Once Reagan moved into the White House, no time was lost in getting down to business. The Office of Management and Budget joined with personnel from the Treasury Department, and began briefing Members of Congress on The Plan. Coveys of Representatives broke bread at the White House, and were briefed on the urgency of The Plan.

Packets of propaganda were prepared for the Washington Press Corps and for editors and publishers and commentators across the country, extolling the virtues of The Plan.

Meetings were scheduled with leaders of labor, business, farm and ethnic groups, designed to obtain their support for The Plan.

An "independent, private sales campaign", initiated by Reagan's "kitchen cabinet" of longtime (wealthy) supporters mounted a massive blitz, saturating the country with supportive arguments. This campaign included, but was not limited to, TV advertising, a national speakers' bureau, and direct mail advertising promoting The Plan.

All this, mind you, in support of something "the people wanted"! The skeptic has to assume that, like a fishing lure, there's a hook.

And, of course, there was.



The Plan was fraudulent.

This skeptic offers the following in support of that charge:

ECONOMIC PLANNING BY GOVERNMENT IS SOCIALISM.

This was an economic Plan, conceived and offered by 'government'. That it was disguised as a remedy for the ills caused by previous economic plans only served to highlight its fabian nature.

That it did not address the real causes of those ills only served to highlight its fraudulence.

All the elements of this Plan which have been sequentially submitted throughout the Reagan years, totally ignore the basic causes of our economic disability.

The guarantee by Reagan that the Federal Reserve Board (The Fed) would remain a sacred cow was one more assurance that it really would not matter how much The Plan shifted things around, insofar as the stated goal was concerned. The economy would still be governed by unelected money-changers, who were the first to benefit under Reagan's 'new economics', by virtue of a fifty billion dollar interest bearing loan from The Fed, to float The Plan.

The absence of any real reform of the 'income tax' only serves to remind Americans that that marxian tax remains a cancer on the body politic, which can be modified, but not cured. That cancer has to be excised, along with its sister in sin, "The Fed", for any real economic renaissance to take place in America.

Perhaps the most glaring defect in The Plan was what was NOT included in it. There was no provision for closing off the bottomless rat hole known as "foreign aid". Americans were to tighten their already painful belts still more, and group was to be pitted against group, to fight over the bones 'government' deigned to throw to them, while unending handouts beyond our shores continue to bleed our economy:

- the grants-in-aid;
- the supply lines for revolutionaries on every continent;
- the favored treatment for foreign manufactures;
- the low interest "loans" to bloody tyrants, never repaid;
- the contributions to the World Bank and its myriad shoots;
- support for uncounted governments already in debt to us.

NONE OF THESE were threatened by Reagan's "voodoo" economics.

The one thing which could really make a difference in ending the devastating deterioration of the American economy - a return to solid money - was never any part of Reagan's Plan.

Will all those Americans who have believed that The Plan worked to their benefit please tell us HOW it did?

# section V

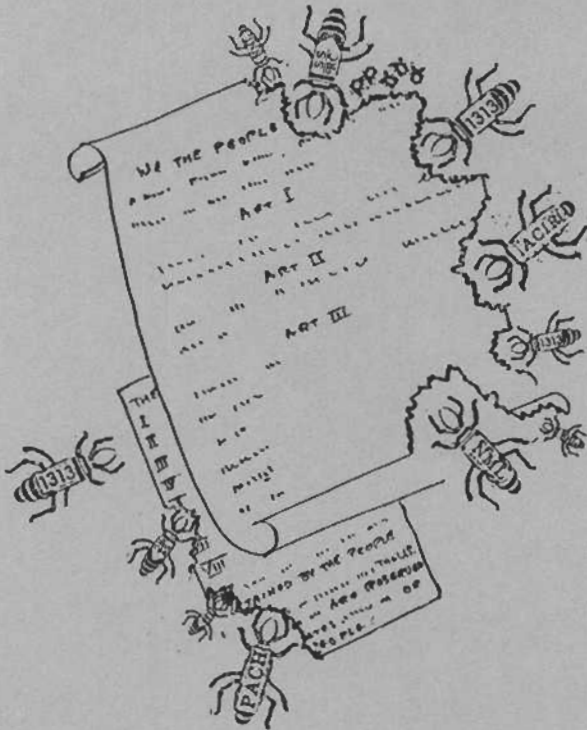

## Conquest by Consent

ch:	pa:
55 Freedom from Tyranny	V - 1
56 Prologue to Planning	V - 6
57 Restructuring America	V - 9
58 Who Are the Extremists?	V - 13
59 "Our Cities - Their Role in the National Economy"	V - 15
60 <i>Recognizing a Menace</i>	V - 19
61 Dismantling Bureacracy	V - 22
62 A Man's Home	V - 24
63 How to Subvert Representative Government	V - 28
64 Establishing Intergovernmental Relations	V - 30
65 Group Dynamics as a Subversive Process	V - 33
66 "The Whole Thing is for Planning."	V - 36
67 Treason and Other Trivia	V - 39

Once there were new frontiers, where asylum could be sought when tyrants stole men's freedoms.

Oceans could be crossed, or borders, to some peaceful place where a new life could be begun. It was such an exodus which made possible the founding of "a new nation, conceived in liberty" which became the United States of America.

The problem with such escape is that it does not stop tyranny. For those who seek asylum in such a move there can be a measure of relief - but tyranny is left behind, to continue its malodorous oppression. Unchecked, tyranny can spread its poison across borders and even oceans, until it circles the globe.

Unless and until it is directly and successfully confronted, sometimes at terrible cost in terms of human life and suffering, tyranny remains an ever growing threat.

The new tyranny now visibly shackling the entire world must be opposed. There are no new frontiers to offer a safe haven.

When this new tyranny began in America around the turn of the century, there were many places the Planners had not been able to infiltrate, and moving away from the strictures placed on one community to another area was still possible. That is no longer true. Now the network of central planning has covered the entire map of America, and to a greater or lesser degree controls every square inch of the land. It has also reached across borders and oceans, threatening all mankind.

This new tyranny came from the same source as that which moved the Pilgrims to seek surcease - the mindset which holds to the "divine right of kings". It is being imposed by a comparatively small group with worldwide interests, whose plans embrace every country and every inhabitant thereof. Aided by hordes of 'experts' (trained by agents of the conspirators), these modern tyrants now have usurped major power of decision on private property in every state, city and county in this land, and they are moving across United States borders into Canada and Mexico. Their presence is being felt in almost every country. Unless they are stopped, and that soon, the perpetrators of this tyranny will have an irreversible capability of control over the entire globe.

There is still the possibility of a deliberate choice between submission and confrontation. Neither alternative is easy. The former may give a semblance of respite, but in the end the nonresistors will suffer equally with those who stand up to be counted. For this particular tyranny must control every living being - even those who have helped to achieve the ends sought.

The would-be tyrants know that any who are not under control remain a constant threat to them. After all, if their collaborators could not be true to the trust given freely by those from whom they wrested control, how could such 'experts' be trusted not to use the tools they understand so well against those who would have to rely on them to keep the human resources under restraint? This time, no one escapes.

It is an exercise in futility to bemoan the numerous obstacles which seem to block any effort to stop these tyrants now:

\* the seeming apathy of a seeming majority;

\* the perfidy of public servants who falsely swear to support a Constitution they do not appear to have even read, let alone understand (or, worse, understand and despise);

\* the shabby machinations of unelected bureaucrats;

\* the disintegration of the moral fiber of this nation and its people;

\* the myriad penetrations of the structure of the lawful government;

and, perhaps most disheartening of all, the failure of the many noble attempts to repel and unarm these revolutionaries in the past.

It is no wonder that so many question whether it is possible to stop such an all-encompassing coup as this. Some go so far as to say that most people do not care about liberty any more - all people want is a handout. The evidence is abundant that this is not so. One positive proof is that, until now, no candidate has gone before the people and told them he intended to use the office sought to destroy their freedom and their nation - and been elected. No matter what else he promised, even that their every other wish would be granted, their every want cared for, he wouldn't be elected.

Never has this been more evident than in the campaign between George Bush and Michael Dukakis in 1988. Each tried to outdo the other in waving the flag, and expressing support for individual rights and freedom. Never mind the dismal record of their past "public service" and what that portends. Ignore the vital matters they did not discuss. Listen only to their expressions of support for the things most Americans cherish.

Megalomaniacs have been returned to office time and again, but it is by a ratio of a declining majority of a declining minority. This is NOT due to 'apathy', but rather to an increased awareness by the citizenry that, no matter WHO gets the office, the people are not being represented.

Knowing that this is not The American Way, but deprived of the knowledge of legal ways to cope with it, Americans are voting with their feet, as refugees from the classical tyranny in the USSR do, but in a different way - our refugees do not move their feet - they stay home on election day. The most desirable candidates - citizens of substance, with a proven record of honor, integrity, capability and patriotism - rarely offer to serve in elective office. Too often, when they do, they are victimized by strategies such as are described in the pages on Political Subversion, and in the final Section of this book.

John Q. Citizen, seeing the evils performed in the name of "partisan politics", opts out entirely. This is not a constructive method of dealing with this vital issue. If this army of disheartened Americans could be mobilized to use the Constitutional power still available to them, to elect representatives instead of politicians, victory over these maggots is not only possible - it is inevitable.

Every tyrant has one overriding fear. That is, that the masses will resist before total controls are established. These tyrants know (if the people do not) that they do not yet have that total control. If they did, they would have used it, and you would not now be reading this book.

This is being written because there has been so little notice of the strategies by which the United States have been brought to this stage of destruction. Knowing how it is being done can provide an insight into the ways and means by which Americans can reverse the tyrannous course being followed today.

In this Section, the strategies involving the usurpation of private rights in property are being examined. At this point in time, it is on this battlefield that the big guns are being brought into action, and those guns are trained on Main Street and your own front yard.

Congressman Charles Lindbergh (father of "Lucky Lindy" the renowned aviator) reported in his book "The Economic Pinch" that he had seen an Establishment document laying out the long range plans for this revolution, which had been distributed to 'Insiders' before the turn of the century. Lindbergh stated that the planning included specifically the removal of private rights in property, because, the document pointed out, people without homes will not quarrel with their leaders. If those 'leaders' have control of all property through central planning, they can decide who shall have homes, and who shall not - and thus control opposition.

When the matters discussed here center on a particular area of the country, it is because we have documentation for the moves taken there. It must not be assumed that the examples are isolated incidents. That there has been a deliberate effort to prevent recognition of a "comprehensive plan" which embraces the entire country is demonstrable. By focussing on local area "comp plans", and providing the semblance of those plans being prepared by the citizens in the area, it is possible to place a smokescreen around each area, which permits fadeout of the interlocking nature of the myriad 'local' comp plans, which comprise the overall Plan.

It must be emphasized that the moves by the Planners which we describe are typical, and not limited to the one being discussed. The planning objective is to have this entire country under a centralized control - a control intended to extend over a worldwide regional network at some undetermined point in time.

Once a strategy is perfected which serves the objective sought, Planners in this country use that strategy over and over, wherever it is needed. It is passed through the network of planning organizations, to local collaborators in California, Louisiana, Illinois, Wisconsin, Florida, Indiana, Washington.

Wherever it is needed.

Just because a problem is big, though, it does not follow that the solution need be complex. The very fact that those who insist on convoluted solutions are usually in a position to have prevented the problem in the first place, says something. These are often also the same people who condemn "simple solutions". Citizens attempting to meet the problems of today are diverted from productive response by slick semantics, and become disheartened by being repelled when they try to do something about the problems.

One does not have to have all the answers before attacking an obvious problem. Sometimes simple common sense is all that is needed. That "one candle" can light a multitude of others. Sometimes all that is needed is for someone to light the first.

There is not enough recognition that many of the problems of today were created to obtain predetermined results. NO 'solution' for them should be accepted, unless it clearly supports the principles on which our lawful government rests. So many of the proffered 'solutions' are far from doing that. Most, in fact, are antagonistic to those principles. In a less critical time, no serious discussion would have given them credibility. Today, laws are passed to ensure their acceptance.

Far too often, citizens are silent, thinking, perhaps, that there is something they have missed, something vital to understanding, which they

alone do not have. NOT SO. If something seems inane it probably is, and no amount of information is going to make it rational. If others are silent, it is probably because they do not want to admit that it also seems inane to them, when everyone else seems to understand.

There was a popular bumper strip some years back, which cried, "Please, Uncle Sam, I'd Rather Do It Myself!" Even while thousands proclaimed this preference, their elected representatives were encouraging Uncle to come into their communities to do things which they could have done themselves - or which - more likely - should not have been done at all. As a result, 'problems' have grown like weeds.

For example: trash. Since Uncle took over the handling of refuse, citizens have faced raw power over raw sewage, but solution to the problem is as distant as it ever was. Some people even seem to be willing to dispose of their government to solve this problem. This may come as a shock to those, but even if they do destroy the lawful government, erase county and city lines, put on all kinds of controls, and voluntarily surrender their own responsibility, the effluvia will continue to accumulate, and a place will continue to be needed to dispose of it. The main difference will be that when Uncle has total control, he can put it anywhere he chooses, and the people will have to accept it, for they will have no recourse.

The American way of doing things in the past was a good one. It made possible the affluent society, by means of which the entire world benefitted, without in the least diminishing the good life it supplied its own people. Even the POOR in America have had it better than 95 percent of all the rest of the people in the world. If that seems an exaggeration, take a look at the information sheet sent to prospective contributors to the War on World Poverty sent by the Infernal Revenuers. Note the beginning level of the Federal 'income' tax. The official poverty level is \$8000. And in 1989, Uncle began to require Social Security beneficiaries - many (most?) of whom are near that level - to pay the full amount of their "COLA" (cost of living allowance) to offset the rise in cost of health care. In some instances, recipients of welfare must turn in their cash register tapes for groceries, as a condition of further aid. Even more than that, Medicare recipients have a percent of their service costs withheld for Uncle! QED.

Unless some way is found to motivate those millions whose pittances are taken to pay their way into bondage; some way to obtain their help in getting Uncle off the backs of productive citizens (who are their real allies), the day must come when Uncle will have to take over all the remnant functions of society. He is preparing for that day, and creating the conditions for the takeover.

All areas must be "equal" in the Brave New World, or only the shiftless and feckless would remain under the stagnation of control. If the same sad situation exists everywhere, there is no refuge for the energetic.

What a loss for the entire world it would have been had there been such controls as now exist, when Henry Ford or Thomas Edison were pursuing their Dreams! Imagine their neighbors running to the authorities, complaining about noise or their violation of a prohibited use of residential property, or damage to environment!

There is no way to calculate what losses the future will sustain due to such interventions today. What undiscovered genius may forever be prevented from contributing to the quality of life through economic, ecologic or exoteric pressures!

If ever there was a time when individual initiative needed assertion, that time is NOW. The place to begin is in every community in the nation. The problems are immense. The solutions are not. The grassroots rebellion has begun. Help it grow!

People need to know what is going on, but only the comparative few who read such books as this, or the few remaining publications which tell the truth without fear or favor, are getting the unvarnished facts.

Every strategy supporting this revolution has had examination by some elected body - in some cases by many of them. Schedule time to attend every meeting of any elected governments which you possibly can. You will be surprised at what goes on there! Then tell your relatives, neighbors and friends what you learn there, and encourage them to attend, too.

This is a simple solution to a major problem - supplying the information about what is being done "with the consent of the people" to those who would never consent - if they only knew the facts!

Recommended Reading:

"The Economic Pinch" Charles Lindbergh 1923 - Reprint, Omni, 1968

Long before he was tapped for the Presidency, Herbert Hoover had been making plans for his occupancy of the White House.

As Chairman of the President's Commission on Unemployment in 1923, he began bringing "social scientists" into the government and gathering data for future use.

When he was appointed Secretary of Commerce in 1924, Hoover took both these adjuncts of the planned society with him. During his years there, the Department of Commerce was a depository for collecting and cataloguing the information which would be needed to extend the "managerial revolution" throughout the whole of government.

No grass grew, once Hoover became Chief Executive, before the transition into administrative governance began in earnest. His Plan for the Great Society was the Plan of all elitists. It was the evidence of this Plan which Franklin Roosevelt scored in his justly famous "State's Rights" speech in 1930, when he kicked off his campaign to unseat Hoover.

For sure, the echoes of Hoover's oath of office had barely died away, when he appointed a "Research Committee on Recent Social Trends" to do the studies necessary to implement The Plan. That this was not yet government policy is made clear in several ways:

\* This Committee was not approved - nor funded - by Congress.

\* It was an Executive action, and was underwritten by the Rockefeller Foundation.

\* No Report was made to Congress or the people during the whole time it functioned.

The work of that Committee has been called "a monumental achievement by the largest community of social scientists ever assembled to assess the social condition of a nation".\* Monumental it was. When a Report was finally issued, its 1568 pages filled two huge volumes, nearly six inches thick.

Apart from its substance, there are several remarkable matters involved in this Report.

Barry Karl, in his biography of Charles Merriam (known as "The Father of 1313", first and longtime chairman of the ACIR - 1313s "federal beachhead"\*\*) remarked that Hoover added an afterthought to the Preface of the Report, which identified it as "a cooperative effort on a very broad scale to project into the field of social thought the scientific mood and...method...,and constructive remedies of great social problems."

That statement was not in the copy of the Report I examined. That has some significance, because it unmasks the pious disclaimers inserted in the Report, that there was no effort to offer solutions for the "social ills" the Report delineated. What possible explanation could there be for that "monumental" task, if no "remedies" were intended?

In the Preface to the Report I studied, Hoover averred that the Report was "a complete, impartial examination of facts". Allow that it was complete, impartial it was not. Plainly the collaborators were chosen for their bias, and not one departed from the social science line. There could be no more positive proof that figures don't lie, but liars do figure, than



is found in these 1568 pages of selected statistics.

Unfortunately (or otherwise, depending on the viewpoint), the Committee did not complete its work until the fall of 1932, and Hoover wasn't slated to be around the following year.

Which brings up another remarkable matter: The jacket of the Advance Review Copy carries the warning:

"CONFIDENTIAL: Not to be released until January, 1933. This Report is given to you in strict confidence in advance of the publication date... It is of the utmost importance that no material contained in this book or discussions of such material be made available to the public before January 1933. Magazines and other periodicals should withhold comment in issues which are mailed or exposed for sale prior to January 2, 1933, irrespective of their stated date of issue." (Emp. added)

Now, isn't that interesting? How much before that magic date, do you suppose, was this Report handed out? To whom, do you suppose, was it given or sent? How trusting - if it was sent to periodicals, who were then asked to hold release! Do you suppose it could have been distributed as much as two months before January, 1933? What difference, do you suppose it would have made, if the "public" knew about it before the November, 1932, election?

How many government reports have carried a warning like that? (But, of course, this wasn't a government report. Congress hadn't approved the study, Rockefeller financed it, and it was published by McGraw Hill, not the Government Printing Office.)

It is more than half a century, now, since this Report was published, but the matters in it are of a nature to make any American livid with anger, even today. The years of silence about it make it even worse, for the "issues" it raised are at the core of every "problem" facing us today.

It isn't just the seditious intent, implicit in the concept of this Report, or the equally seditious conspiracy to take over the functions of representative government, although God knows those are enough. But both these pale in the face of the arrogant assumption of authority over every living thing, every inanimate object, and every movement or act conceivable.

Here, in this musty Report, is the embryo of today's environmental movement; zero population growth; abortion, sex education; immigration and miscegenation; the Black revolution; the moral crisis; child care by government; the ERA; the "civil rights" Court decision in the Serrano case; the social gospel - you name it, it's there.

Basic to the Committee's Findings is this bald statement:

"Of the two ways (only two?-ed.) of improving the qualities of a people, the first, mutation, may be dismissed, since our knowledge is too limited (it isn't any more, is it?-ed.); the second, selection and breeding for desirable qualities, offers possibilities."

Is that clear enough, my fellow cattle? Now you know what they mean by "human resources".

With this knowledge, some understanding of the reason for the proliferating studies of genetic engineering may be engendered.

With this knowledge, perhaps enough Americans will get "mad as hell", and let these mattoids know that they are NOT GOING TO TAKE IT ANY MORE.

Recommended reading:

\* "Report of The Research Committee on Social Trends" - your public library, or University Repository

\* Barry Karl: "Charles Merriam and the Study of Politics"; University of Chicago Press, 1974.

\*\* Jo Hindman, "Terrible 1313 Revisited", Caxton, 1961

When the richest men in the world decided around the turn of the century that the world and everything in it should be theirs, it was natural that they turned to education as the tool to open their oyster. Cecil Rhodes and his Dream; Andrew Carnegie and his; John D. Rockefeller and his; a handful of similar financial giants; each began an assault on civilization. All were aimed at the same Goal, but the most effective of these was Rockefeller, who used his native acuity, his power and influence, to draw other powerful and influential men into his orbit. He furthered their schemes, and they reciprocated.

Frederick T. Gates was an early Rockefeller recruit. Gates had already proved his zeal for the Dream, when he met Rockefeller. Almost singlehandedly, he had launched the University of Chicago (ChiU) for the Pillsbury family, with funds from the flour fortune. Gates was seeking additional financing for ChiU, and Rockefeller was high on his list of potential donors. Gates not only got what he sought, but he also earned Rockefeller's admiration for his abilities. That admiration blossomed into an association which made history - albeit not publicly. Gates became a Rockefeller agent, and, instead of having to beg for money, he soon was in a position to dispense it.

Together, he and Rockefeller "cultivated the vineyards of American education - in cities, rural counties, grade schools, high schools, colleges, medical schools, and other advanced training" (quote from a friendly biographer of JDR).

From their association came the penetration of local schools through the General Education Board, and the penetration of ChiU by the Planners.

In the early years of this century, Chicago became a magnet for leading lights in various radical movements, and it was a perfect setting for the headquarters for the regional army only then beginning to shape the strategies for revolution. It was a natural for the budding Planners to be drawn to the center of radicalism, and to set up a GHQ (general headquarters) next to the ivy covered halls of ChiU - at 1313 East 60th Street.

From the earliest associations formed to further "the planning idea", once they had a permanent address, the planning movement rapidly grew into an international conglomerate, which called itself "1313", probably to signal to new initiates that the additional units were still part of the combine, regardless of any identity of convenience they assumed.

Jane Addams had built Hull House in Chicago, ostensibly as a refuge for the homeless, but it also served as a rendezvous for an assortment of visiting radicals.

City Club in Chicago was habited by such luminaries as Charles Merriam, Harold Ickes, and Julius Rosenbaum. Merriam was a "social science" professor at Chicago U, who was chosen to head the 1313 combine. Ickes had served as campaign manager for Merriam when he ran for Mayor of Chicago in 1911, and they remained close associates until Merriam's death.\*

When Ickes went to Washington to serve in the Roosevelt cabinet as Director of Public Works, he brought Merriam in to help set up the National Resources Planning Board (NRPB), the agency created to bring "social science" into full participation in the government.

Sending for Merriam was more than just fortuitous, for Merriam had

helped to coordinate the 1313 setup, and was the first director of its activities.

As 1313 began its penetration of government, it spawned numerous ancillary groups, like the intricate filaments of a spiderweb, the more effectively to entrap the unsuspecting prey. At first, all of these headquartered at 1313, but as they proliferated, it became necessary to relocate some of them in other areas.

In short order, after the "Roosevelt Revolution" began, the executive branch of the government was swarming with 1313 agents of scientific management. It was some of these who met together with Dr. Willim Wirt, and exposed to him their plans for America's future. Remember, one of them was from Public Works? Remember how John O'Connor mourned "Little did we know that most of what the plotters predicted would come true"? Little did he know they were not predicting - they were discussing the new very real scientific revolution, only then gearing up for action on a national scale.

Where were the investigative reporters then? Here was a group of government employees, charged with heinous abuse of the public trust. It would have been a cinch to prove Dr Wirt was right, because those people were being paid to do what they were doing, and they were doing what they said they were doing, and what Dr. Wirt had said they said they were doing. But no one broke the story.

The NRPB did not have to strike off into uncharted territory, as it began to move the revolution inside government. Its job was to insert strategies and techniques into government which had already been tried by 'volunteer' groups - without legal authority.

The first 'volunteer' experiment in comprehensive planning was begun in 1924, when an unofficial pilot program was formed as a "TriState Regional Planning Federation" which included Pennsylvania, New Jersey and Delaware. A similar group did the same thing, about the same time, for New England. A third was designed for New York, Rhode Island and Connecticut. The latter group found favor with the Governor of New York, and with his blessing a continuing Plan for that State was sparked. It's a safe bet that the statistics compiled by these 'volunteers' found their way into the files of the NRPB.

Among the contributors of these stats, almost surely, would have been the Public Administration Service (PAS) and its affiliate, the National Municipal League (NML). For many years, these two groups had been the vanguard of "city manager government". In 1940, PAS published a review of the city manager movement, in which they openly stated that the intent of the movement was "a new form of government" unhampered by such antiquities as "separation of powers" and "checks and balances". It was also PAS and NML which parented the initiative, referendum and recall (IRR) to facilitate their assault on representative government.

When the NRPB was created, its first task was to survey the progress of the 'volunteer' planning movement. It found some 700 city planning boards already at work, most of them 'volunteer'. Most of these were in the eastern part of the country. There was only one County planning board at that time. It was in Wisconsin.

One year later, the NRPB reported that there were 39 more city planning boards, and 717 of the total were now "official". By then there were 61 County Boards, 23 regional boards, and 30 "municipal" boards. The NRPB reported that almost all of these were 'nonpolitical' and had university professors on them. 'Nonpolitical' means that they were not official. "Not

official" means that they were not approved by representatives of the people (that means they were operating without consent of the people - outside the law). The presence of professors was noted in the report, but not explained. These 'volunteer' boards assumed the power to begin the restructuring of America.

The NRPB reported that it had "stimulated interest in planning" by offering assistance to encourage State planning boards. The assistance was, of course, conditional. All of the conditions rested on guarantees from the state executive NOT from the representatives of the people.

To get that assistance, the governor had to:

- \* promise to press for legislation to give the state board legal standing;
- \* appoint NRPB-approved members to the board;
- \* guarantee office space and stenographic service;
- \* guarantee a ten year planning program, and a study for a transportation plan (an interesting requirement, transportation);
- \* appoint a 'planner' to direct the Board;

The Governor of New Hampshire was the first applicant.

By the end of the next year, thirty nine more governors (out of the 48) had compromised representative government in their states, and started a process which threatened representation for all America today.

The NRPB Report crowed:

"State and interstate planning is a lusty infant...but the critical test will come when bills are pending in legislatures for the establishment of continuing planning organizations."

One by one, the elected bodies in America have succumbed to the Planners. That is understandable, in the absence of public protest. The problem is, that while all this was going on, the public had no knowledge of it, so how could they be expected to protest? (WHY didn't they have that knowledge?) The legislators did not know that there was a scheme afoot to trap them into going along. (WHY didn't they know?)

The rationale for central planning seemed logical, the attraction of "free money" from Washington so great, how could they be expected to resist, absent any compelling reason to do so?

Just in case they did resist, 1313 was prepared to neutralize that resistance, through any of the myriad 'associations' set up in Chicago.

The Board of Supervisors in El Dorado County, California, found this out, when the imposition of the regional government at Tahoe forced them to search for the root of the problem. Among the shocking disclosures that examination revealed was the fact that the County was paying dues to more than 60 1313 agencies set in motion by previous Boards, and routinely approved by themselves! The two cities in the county were equally involved in paying for their own destruction.

To understand how deep the penetration was, the following are a few of the 1313 bodies which were being supported with County funds:

The State Associations of County:  
Supervisors, Assessors, District Attorneys, Clerks,  
Counsels, Data Processors, Data Process Managers, Planning

Directors, Public Defenders, Sheriffs, Peace Officers and on and on.

Support of these organizations by paying dues is not the only problem they present. Local governments pay for transportation for local officials who are paid from County funds to attend these 1313 meetings, where they are given 1313 'solutions' to local problems, to use in their official capacities. It is these associations which see to the acceptance of 1313 schemes at the local level.

The fact that local elected officials rubberstamp the 1313 programs does not constitute representation. This is usurpation.

Recommended Reading:

"The Red Network" biblio - a comprehensive list of Chicago radicals in the 1920s, Elizabeth Dilling, self publ. 1934

"City Manager Government in the United States", Harold and Kathryn Stone, Don Price, PAS, Chicago, 1940

"If this program proposed by our so-called National Resources Planning Board, were put into effect, it would wreck this Republic, wipe out the Constitution, destroy our form of government, set up a totalitarian regime, eliminate private enterprise, regiment our people, and pile on their backs a burden of expenditures that no nation on earth could bear."

These are not the words of some 'right-wing extremist'. They express the reaction of a credentialed 'liberal' after he examined a copy of the NRPB Plan in 1943. John Rankin even prefaced his remarks by stating he found some good in The Plan, but he decried its totality.

It was 'extremists' of the left who created this blueprint for restructuring America. As this Plan becomes the operational government of the United States, its developers become the founding fathers of the new order of society. Permitted to continue, this subversion will find the reputations of the Alger Hisses, the Dean Achesons, the Marshalls, the Trumbos, the Faulks - 'laundered'. The dark days of their activism will emerge as a time of 'persecution' and the revised standard version of their roles will be all that history records of them. To postpone the truth of participation in the reconstruction is to participate in the cover-up.

Frederic Delano, aging maternal uncle of FDR was the nominal head of the NRPB, but the record shows that Roosevelt, himself, was the dominant figure in its work. He had full knowledge of its purpose and potential, and was kept informed of all its activities. It was his delegated authority which permitted it to function. At his command, all Executive Department heads were cooperators, and they served at his pleasure.

Roosevelt presented the last official report of the Board to Congress as his Plan for a Postwar America, and he urged top priority for it. In a statement in opposition to that Plan, Congressman Noah Mason told his colleagues that if they did that, they would be putting this "socialistic scheme" ahead of the war effort.

It was Noah Mason's probing which disclosed that the Director of Research for the NRPB was one Eveline Burns, recently a British subject, and an activist in the radical movement in England. She and her husband had been "the conduit for the underground railroad operating between the United States and Great Britain, through the offices of Felix Frankfurter and Harold Laski of the London School of Economics." (Noah Mason, Remarks to Congress on passage of the NRPB Plan).

The London School of Economics is the Fabian-founded British counterpart of ChiU. Mason noted that it had "specialized in turning out of braintwisters who are expert in producing calculated frustration on a mass scale, by means of planned confusion designed to end up in regimented chaos". If that isn't a fit description of the social science community here, what is?

Both Drs Burns were important figures in building the planned society for Britain, which contributed greatly to the decline and fall of the British Empire, and apparently they were willing to do as much for America. Ms Dr Burns began her service to her host country by helping to write the Socialist Party Platform for 1932, which called for the same kind of programs she later helped to incorporate into the NRPB proposals.

Other acknowledged collaborators on the NRPB Plan were:

ALBERT LEPAUSKY, who surfaced in the 1960s as an advisor on the Tahoe Regional Area Plan;

VICTOR JONES, professor of political science at UC Berkeley, and advisor to ACIR;

BEARDSLEY RUMML, deviser of pay-as-you-go withholding tax; sometime executive director of the Laura Spelman Rockefeller Memorial Fund;

A. A. BERLE JR developed a banking act in the thirties, strikingly similar to the one passed recently by Congress;

REXFORD TUGWELL, longtime revolutionary socialist (Lusk Com. Report), and chief scribe for the World Constitution;

PAUL PORTER Field Sec. for the L.I.D., who had written a tax plan for the Socialist Party;

ALVIN HANSEN Harvard professor;

CHARLES MERRIAM Dir. American Society for Cultural Relations with Russia, 1934 (formed to break down antipathy toward the Soviet government);

LOUIS BROWNLOW organizer and first director, Public Administration Clearing House (PACH), master coordinator of 1313 associations;

and an assortment of such leftist figures as LOUIS WIRTH, CLARENCE DYKSTRA, LEON HENDERSON, and WILLIAM OGBURN.

Of the 29 paid staff at the time Congress cut off the NRPB funds, all but seven were transferred to other executive jobs, some at increased pay levels; five of the seven were placed on other planning boards, where they were in position to aid in the new phase of implementing the Plan. That new phase was the creation of a demand for planning at the State and local levels.

THESE are the real extremists, not the patriots who "have no wish but for a good government" under which they can live in peace, and not have to risk their jobs, their reputations - even their lives - to warn of this threat from within.

Recommended Reading:

"Ordeal by Planning" John Jewkes, London, 1960  
 "A Passion for Anonymity" Louis Brownlow, University of Chicago Press, 1958



CONQUEST BY CONSENT - 59 - OUR CITIES - Their Role  
in the National Economy

The discredited National Resources Planning Board (aka National Resources Committee), conceived, nurtured and supported by agents of the infamous "1313" conglomerate, sired the programs which have become a very clear and present danger to the rights of citizens regarding "acquiring, possessing and protecting" private property (rights guaranteed in most State Constitutions, as well as the Federal Constitution).

The 1937 NRPB Report, requested by such 1313 organizations as the National Conference of Mayors, the National Municipal Association (now, the National Municipal League), and the Society of Planning Officials, identified the cities of this nation as the primary target for beginning reconstruction of these United States. That Report did much more than that - it offered policies to achieve the goal of reconstruction, and made recommendations for the strategies to be used in doing so.

Twenty one policies; twenty one sets of strategy.

The record is not clear whether those policies began to be physically implemented before Congress was asked to approve them six years later. They may have been used just as guidelines, to fend off conflicting activity. It is, however, beyond the shadow of a doubt that today's Planners are faithfully following that 1937 blueprint. Presidential Orders, HUD directives, and Congressional programs all embrace the concepts embodied in that Plan - and some not even imagined then.

It is abundantly clear that there is an army of officials in Washington (and in every State) who are willing - no, anxious - to exchange the liberties of the citizens (who pay their salaries) for federal handouts, with which to enhance their own power and influence, even as they fortify the power and influence of the cabal of financiers who set the Goal.

You see, the States are not required to comply with those directives. The ninth and tenth amendments to the Constitution make that clear. Only if elected officials wish to continue to swill at the public trough must they accept federal planning. And the Planners see to it that they do continue to accept the carrot and the stick of central planning. For 40 years, the standard approach toward accepting federal funds has been:

"The money is just lying there. If we don't get it, someone else will."

That 50-plus-year-old NRPB Report reveals a sure understanding of the possibilities involved in local needs, as well as the source and intent of the programs it proposed. There is no room for doubt about that as the Report compares the free and independent cities of this country, with the controlled development of cities in Europe:

"The conception of government in European countries led...to greater concern on the part of government for the welfare of individuals and communities."

Yes, but you see, OUR government was different. Here, individuals and communities were to stand or fall on their own. They were to provide for their own welfare. Those elected to serve in the federal government were to

oversee that IT functioned under the Constitution, and to remove obstacles which hindered proper use of the liberties it provided. It was "verboden" for Washington to actively intervene in individual or community decision making..

"The cities of Europe, in contrast to the cities of America, are much more closely connected with the national government."

Yes - but HERE it was different. THOSE governments in Europe had no legal constraints separating them from the cities. Under our Constitution, the demarcation is clear, and clearly stated in the ninth and tenth amendments.

"The fact that, in general, European countries have centralized government has led to the emergence of a national policy...reconciling local needs with those of the nation as a whole."

Yes. But in America there was a Constitution which separated powers, and frustrated attempts to set "a national policy".

"Through larger measure of social control, European municipalities... have been able... to mitigate the blighting influences of rapid growth, and of the unsound conversion of land from one use to another."

Sound familiar? It should, for the Planners have spent the last half century 'educating' Americans to yearn for the control over their lives, the regulation of their enterprises, the interdependence of their relationships with each other - in short, for "social control" - the very trigger which prompted the Pilgrims to leave their native lands in search of a place where they could control their own destiny!

All across the length and breadth of this country, 'government' is reshaping the lives of Americans to conform to the Plan, and the reconstruction hinges on "the role of the cities in the national economy".

Thus, in California (which does not differ in any significant degree from other states) for instance, the Planners can publicly reveal that for every hundred citizens there, 94 live in existing urban areas, while in the same breath they deplore "urban sprawl". They can - and do - castigate those citizens who wish to escape from the asphalt jungles to the peace and quiet of the countryside. To the Planners, these are selfishly attempting to get something for themselves at the expense of society. The Planners charge that such citizens are polluting the natural beauty of the land, denying access by others to a national treasure, threatening the ecological balance, or causing fiscal problems - especially if they want to use 'public utilities' such as electricity or phones.

In California, the Planners have pointed out that only 2.5% of the land in the State is "urban" in character, and 94% of the citizens are concentrated in the smog-ridden cities - on that miniscule 2.5%. They never blink an eye as they demand that those small parcels of land inside city boundaries yet undeveloped must be "infilled", before citizens are permitted to migrate to "contiguous land", outside the city, even while, with forked tongue, they deplore the crowded conditions inside the cities. They exact contributions of private land in return for the privilege of

building a home, and demand that whatever is built must meet their standards. In fact, Planners do not seem to recognize that there is such a thing as "private property".

It is of no moment to the Planners that John Q. Citizen wants to build a home on that "contiguous" land because he owns it, and he does NOT own the piece in the city which must be 'infilled'. Private investment in property means nothing to these present day pharaohs, as they boast of court decisions which have cost private citizens millions of dollars and untold heartbreak, and - a most valued possession - liberty.

As "the good of society" begins to take precedence over individual rights, an American's ability to plan the future for himself and his family becomes an anachronism. "Profit" is a four letter word to the Planners as applied to the individual. However, they can think of a thousand ways for 'government' to 'profit' at the expense of the citizen, and not just fiscally. There is no dollar value which can be applied to the loss of power which results from the planned diminution of rights in property.

The 1937 NRPB Plan for our cities makes it perfectly clear that the very things which made these United States unique were to be systematically modified to "so alter the government of the United States" that it could be merged with all the world, in an administratively controlled structure "outside the realm of politics".

This is why, today, Americans are finally face to face with the reality of that 'impossible dream'.

#### Recommended Reading

"Our Cities - Their Role in the National Economy", and other Reports from the National Resources Committee - your local federal depository

CONQUEST BY CONSENT - 60 - Recognizing a Menace

"To me, it is truly alarming that such a destructive force as this could grow to its present size and power, without the Congress and the country becoming more aware of its dangers than it apparently has..."

It WAS truly alarming that the National Resources Planning Board had been permitted to "work its will" on the government of the United States for ten years, without Members of the Congress making a connection between the reports of the New Deal programs, and the source of the programs they were being asked to approve.

It was only in 1943, when the NRPB presented its blueprint for a politically planned economy to them for approval, that the Members took notice of what the Board had been doing. When they did, even died-in-the-wool Democrats had difficulty defending it.

Looking back, it is almost beyond belief that Congress should set up a unit such as the NRPB - even with the limited powers it was originally given - and then turn it loose with no oversight by any committee of either House or Senate.

Frederick C. Smith (R.Ohio) made the above remark to his colleagues in 1943, as a preface to reporting his findings on what the NRPB had been doing, and how and why, during those ten years.

Had it not been for the fact that the NRPB released its final Report for approval of Congress just before that body received the executive budget for 1944, the NRPB might have finished its job without interference. As it was, when the funding of the Board came up for consideration, and the Report became an issue, Congressman Smith had finally done a study of the Board, and had a report of his own to present.

His staff had done a thorough research into the Board and its activities since its creation by Congress in the Economic Stabilization Act of 1931 (ESA-31). That Act resulted from recommendations made by the Hoover Administration's Commission on Unemployment, "in response to the problems" which followed the stock market crash of 1929.

One of the important issues Congressman Smith uncovered was how legislative bodies are used to supply the necessary permission to obtain public monies for projects with undisclosed purposes. The strategy used to embed the NRPB within the framework of our lawful government is important, for that strategy has been, and is being, used as a continuing revolutionary tool.

Among other things, ESA-31 provided appropriations for a series of public works to "get the economy moving again". The "public works" consisted of structures to house the proliferation of bureaus needed to plan interventions, for the stated purpose of heading off the expected 'depression'. ESA-31 called for a 6-year plan of acquiring sites, constructing buildings, and similar matters.

After studying the statute, Congressman Smith stated categorically:

"There is not the remotest possibility of reading into that Act any authority whatsoever for performance of the whole range of functions that are now being carried out by the National Resources Planning Board. Certainly, there is nothing in that

Act which gives this federal Agency ANY authority to plan a new social and economic order, as its activities clearly indicate it is undertaking to do."

So much for Congressional consent to the NRPB Plan. It simply didn't exist. We shall see this strategy in action again, as we look at the creation of the Federal Advisory Commission on Intergovernmental Relations, and at the process used to obtain a management and control system.

Congressman Smith's report to his colleagues contained many facts of great importance today. Calling the Board "an instrumentality of Roosevelt", Smith said, "HE refers to it as 'the planning arm of my Executive Office'."

The Congressman described the planning umbrella which the NRPB had constructed over State and local governments, and the regional offices located in Boston, Baltimore, Richmond, Va., Atlanta, Indianapolis, Omaha, Denver, Portland and San Francisco, with Alaska (not yet a state) as a separate planning unit. Below these, and under their direction, were the State planning units, and, under them, the local planning agencies.

Special planning committees had been set up nationwide under the direction of the Department of Agriculture. In total, nearly a hundred planning cells were actively pursuing the revolutionary objectives in 1943 - all without the sanction of Congress - or the knowledge of the citizens.

Nor was that all which was in the works. Harvard Professor Alvin Hansen, a 'special advisor to the NRPB' was "working in cooperation with Chairman Eccles, of the Federal Reserve Board, on problems of fiscal policy" relating to regional development.

In short, this was a Plan "which spreads over and involves the cooperation of practically all of the agencies of government", according to Charles Merriam, in an article in 1941. (Public Administration Review, Vol. 1, # 1).

In making our Nation over, Congressman Smith remarked, the Planners "planned to raze our cities and construct them anew".

Which brings up something which has puzzled us for a long time. Malls. The question of what was so important about them that, almost simultaneously all across the country, every city and town seemed to find "malls" necessary. Here, in this 1943 report, is the answer. The malls were not important in themselves. They were a means of moving existing businesses out of the way, so the Planners would have free access to the central core of the cities, to "construct them anew".

Now that strategy is providing another bonus to the Planners. For 'government' to take over downtown development through urban renewal is costly, and not cost-effective. So now the Planners are gently - but firmly - persuading the citizens to do it for them. Out of the recesses of one of 1313s "law factories" has come a 'model law' which has been placed in State statute books by compliant State legislators. It allows activation of "Business Improvement Areas", known as BIAs.

BIAs have become the preferred method of "downtown renewal", because they not only keep well-intentioned citizens too busy to concern themselves about larger aspects of the revolution, but the state laws passed to 'legalize' such political shenanigans encourage 'volunteer taxation' - businesses initiating taxes on themselves to obtain services the lawful government cannot provide, because it is spending the money on social programs. Fuzzyheaded decisions on land use have eroded the local tax base, and pushed the lid off city and county budgets. Funds to pay for core

projects are often nonexistent.

Using the BIA tactic, local business men and women are enticed into wanting the "improvements" enough to "assess" themselves to pay for them. Where local businesses resist the temptation to "improve" the downtown area, change agents are available to assist local progressives in using the mind control techniques of 'the politics of change' to bring the recalcitrants in line.

This is compatible with what Eleanor Roosevelt, in a book titled "This Troubled World", called "our real and ultimate objective" - a change in human nature, to fit us all into the planned future world. And the NRPB Plan called for a system of management and control which would do precisely that.

Aware of the importance of coming generations in continuing the Plan, the NRPB encouraged invasion of the schools to teach America's children the blessings of bureaucratic planning. Also encouraged in the NRPB Plan was education in 'family life' - to help the children work out a "functioning personal philosophy" - which was not at all personal, but was an echo of the bureaucratic philosophy which undergirds the "planning idea". No wonder so many citizens now, after 40 years of indoctrination in the public schools, are joining in promotion of the planning revolution!

For twelve long years after giving its permission for construction of public buildings, Congress remained unaware that its 'consent' had been stretched to include restructuring of the entire gamut of social, political and economic activities of the 'government' and its people.

Twelve years, during which powers the people had delegated to representatives were transferred, one by one, to the executive, to bureaucrats, and even to totally unaccountable "citizens' advisory committees".

It was this transfer of power which made possible the continuance of the "scientific revolution" even after Congress repudiated The Plan and dissolved the NRPB.

It is more than possible that some members of Congress knew what the NRPB was doing, and even assisted it. Some may well have been aware that the nature of its duties was changed by the Executive in 1933. If so, their silence demonstrated their consent.

For when FDR created the National Industrial Recovery Act (later known simply NRA - the Blue Eagle), and got it approved by Congress, Harold Ickes, by a sleight of hand, recreated the NRPB as an adjunct of NRA, but with a whole new mandate. Among its duties now were preparation of "comprehensive plans" for regions as well as states and local governments; surveys to determine population, existing land use, industrial sites, housing, and natural resources; research into the habits, trends and values of the "regions" (read, 'people'); coordination, cooperation, and correlation of Federal projects with local initiatives.

There is an existing record of one of those "surveys" taking place in El Dorado County, California in 1959, in which the planners found that the horrible possibility of proliferating housing for citizens of these United States threatened the natural beauty of the County, and demanded a planned program to contain the growth of the County population!

So began actualization of the revolution. It is not only alarming. It is patently unConstitutional. It denies the Christian/Judaic ethic, which holds that the Lord gave man dominion over every living thing on earth - except his fellowman. It reduces the individual to a unit of "resource".

One can imagine the heady spirit of these revolutionaries as, at public

expense and with full approval of the White House, they charged across the nation mobilizing their agents in the field, and stimulating sympathizers into action to begin the reconstruction of society. The rapidity with which they were able to penetrate States and local governments was not happenstance. The academic social scientists had been assiduously preparing the way AND the needed cooperators, and they were ready for the Call when it came.

That Call was issued by the NRPB in a series of 17 meetings with local Planners at selected points around the country. That was when the signal was given, and briefings held on ways and means.

Can you imagine the consternation of that army of collaborators when Congress blew the whistle on their headquarters?

But the Planners never give up, and those in Washington immediately picked up the pieces, and moved to Plan B.

Recommended Reading:

"The Secret Diaries of Harold L. Ickes" 3 Vols., Heidenfeld & Nicholson, England, 1955

When Congress dissolved the National Resources Planning Board, rejected its Plan, and added its staff to the ranks of the unemployed (however temporarily), Congressman Smith remarked that he anticipated further problems with the planning movement. His concern was quickly justified. The NRPB staff was immediately put back to work, as we have seen. And a cabal of Members of the Senate put together a package of legislation to implement the NRPB recommendations, despite the majority vote against them.

That "package" was not passed then, but over the years, one by one, the whole program has been put on the books, some of it modified, some in even more radical form, until, today, to all intent and purpose, these United States and their people are under the administrative governance proposed by the NRPB.

In 1948 the people of the State of New Jersey sent one Robert C. Hendrickson (R) to the United States Senate. Senator Hendrickson had been a New Jersey State Senator. As such, he was instrumental in forming, and was appointed a Member of, the very first State Commission on Interstate Cooperation (CIC) in the country in 1935. The CICs were the forerunners of today's State Commissions on Intergovernmental Relations (CIRs). Only the name was changed.

One of Hendrickson's first acts in Washington was to introduce a bill (S 810) to create a Federal body on Intergovernmental Cooperation. Hearings were held on it during that entire session of Congress, but it never got out of Committee.

But the Planners never give up. The next session Hendrickson entered the same bill, revised and amended, and now numbered S 1946, which reached a floor vote, but did not pass. In the 82nd Congress, he introduced it again (S 437), and several similar bills were also introduced that year by other Senators. All failed to pass. Then Senator Herbert R. O'Connor (D, Md) introduced S 1146, which did pass the Senate and was sent to the House, but for some undisclosed reason it was called back before any action was taken. As we have noted, the Planners never give up, and so, finally, in the 83rd Congress, in 1953, a new version was introduced. This bill (S 526) was rewritten to fit the circumstances of that time.

Those circumstances included a number of Members who were there and voted against the NRPB, and still remembered its proposals. The fact that there had been growing restiveness throughout the country against the "alphabet soup" left in Washington by the New Deal, was a factor. Men returning from world war 2 were fed up with having to take orders. On their return, they found that they were faced with still more orders from Uncle, and they didn't like it. Representatives were being sent to Washington with a mandate to get this country back on course. So the climate was not right for another version of the NRPB.

To meet these new circumstances, this latest bill for a Commission to replace the NRPB was "for the purpose of studying and making recommendations" about fiscal policy; ways and means of eliminating duplicate and overlapping services; allocation of governmental services to increase economy; the development "within the existing constitutional framework" of policies and procedures to overcome obstacles to efficiency. Now THIS sounded like what the people back home were demanding.



And so, in the name of economy, efficiency and eliminating bureaucracy, Congress approved the replacement for the National Resources Planning Board, and they called it the Advisory Commission on Intergovernmental Relations. But a funny thing happened on the way to the Great Society.

The first chairman to be appointed to the ACIR was Dean Clarence Manion, who believed in all the reasons publicly stated for creating that Commission. He also believed in the Constitutional Republic. He was also a professor of Constitutional law. A former Democrat, he became an Eisenhower Republican, and had been an active campaigner for Ike in the 1952 election. He enthusiastically began to fulfill the mandates he understood were required for the new Commission, from the language in the statute. For a year, he worked diligently with the Commission Members and staff to unscramble the mishmash of powers and duties which had developed during the 20 years of New Deal activism. He was ready to present his remedies to Congress in such a convincing Report that they would be impelled to implement them.

But before he could present his Report, he was fired - ignominiously removed from a job he was hired to do - because he did it too well. Dean Manion, Constitutional lawyer, and teacher of Constitutional law, was prevented from making his recommendations on policies and procedures to correct the problems of government "within the existing constitutional framework", and was replaced by Meyer Kestnbaum, clothing manufacturer from Chicago, and Fellow of the Council on Foreign Relations.

That first Commission on Intergovernmental Relations has gone down in history as the "Kestnbaum Commission", and it performed the service expected. Straightening out the twisted language of the bill that created it, the Kestnbaum Commission followed the intent of the statute, instead of the stated requirements.

Immediately, the pressures mounted to have the Commission made a permanent fixture in the federal government. With election of new Members of Congress, who not only knew nothing of the years-long efforts to avoid the pitfalls of the planning idea, but also were less knowledgeable of the Constitutional issues, the road ahead was clear.

In 1959 the planners achieved their objective - a permanent federal Advisory Commission on Intergovernmental Relations, new improved version of the old National Resources Planning Board.

No longer required to operate by stealth, the ACIR is carrying on its work in full view of the public. Manned by an impressive list of elected federal, state and local officials, staffed by dedicated Planners, ACIR regularly issues 'reports' which are available to anyone who asks. In those reports may be found the germination of the "suggested" legislation which sees the light of day in the Council of State Governments' (CSG) roster as recommendations for states and local governments to rubberstamp, strategies for obtaining 'consent', and techniques to overcome resistance.

The assorted governors, congresspeople, and state legislators who 'preside' over ACIR meetings, receive the dicta from the Planners, and disperse to sub-meetings with their counterparts in the 1313 network, such as the National Governor's Conference, the Council of State Governments, the State Associations of Counties et al, and provide the latest word from Olympus on the next steps into the planned economy. Having received The Word, these collaborators then filter back into their communities, and begin implementation of the ACIR directives.

When citizens begin to elect representatives instead of politicians, the death knell for ACIR will be sounded. Until they do, the conquest of America by pitchmen for the Planners will continue.

Samuel Gompers is quoted as having expressed his dissatisfaction with the administration of the government of the United States back in the 20s, by saying, "The inmates are running the asylum." Judging by the talk shows on radio, the letters to the editor in the press, and casual conversation with the man (pardon, Gloria) in the street, that is now the general opinion of the average American today.

The serious student of current events - their cause and probable effect - might well come to a different conclusion. For, if this be madness, it must be of the mattoid variety - the madness of persons whose ideas and aims simulate those of talent, and even genius, but marked by radical absurdities, difficult to fathom.

Putting some of those 'absurdities' under the microscope of common-sense brings into focus the genius which is able to make idiocy acceptable to the sane mind.

Take the matter of housing, for instance.

Time was, when the dream of a home of one's own was not an impossible dream, in America. Then, a determined young couple could find an affordable lot, and build their dream, themselves. I know. My husband and I did just that.

We had a small 'nestegg' (thanks to saving 'war bonds') and a very sizeable dream. We paid for the lot with the bonds, and, on the strength of that equity, purchased a "prefabricated" house, which we put together ourselves. (Never mind that no nails - which were in short supply after the war - were included in our 'package'. A trip to San Diego and back from Redondo Beach where we lived at the time, stopping at every hardware store on the way, supplied enough to put the house together!)

When the parts were assembled, a roof over our heads, a living room and kitchen, two bedrooms and a bath were ours - for about seven thousand dollars, including the lot and the trip to San Diego.

Young people today can't do that.

Even if such a lot could be found today, it would cost more than the average young couple should spend, and they wouldn't have been able to save enough to pay for it, anyway.

Our little house wouldn't have had the approval of a "planning commission". (Fortuitously, there were none in those days!) It didn't have enough floor space for one thing (we thought it did). We moved in before the interior walls were installed, because they didn't come with the package, either, and we didn't have enough money then to buy them. (The Planners wouldn't let us do that, today.) I used the firebreaks between the studs to display my 'treasures', and missed them, when the walls were finally installed.

We didn't have a garage, or even a carport, and the lot was so narrow we had to turn the house sideways to get it to fit. As a result, the front door didn't face the street. (Would that be permitted today?)

A few years later we built an addition on the back for my folks. There was no 'zoning' then, to say we couldn't, and no neighbors ran to the city fathers to object.

There were other ways as well, for young folks to get their dream house, then. Maybe the old folks had more property than they needed or wanted, as they left youth behind, and would cut off a piece for their

kids. Many did that.

But those were the happy days - for it was just about then that the radical absurdities began, and, surprisingly, found support among the general population. Just about then, the Planners moved into OurCity. Their presence was not announced, but it was obvious - only we did not know it then.

The first any of us knew they were there was the night the city council met to decide the fate of the little green bus (see Chapter 9). Looking back today, one has to wonder if the bus issue was not deliberately provoked, to cause the chaos needed to provide a climate for change. For that was also the night when the first discussion of a "city plan" was held. In short order, OurCity had a "city manager", who quickly produced a Plan, and a "hearing" was held to present it to the citizens.

The citizen reaction was mixed. Disbelief was probably the strongest response from those present, because the Plan was so far removed from the projected layout of the city that had grown over the years. You couldn't call those early projections a "plan" - they were simply logical extensions of expected growth, sensibly preparing for a need which was already visible.

But with this Plan, the whole area within the City boundaries was to be metamorphosed.

The visionary maps of a reconstructed City showed that the second high school planned for NorthCity had, as if by magic, become a public park. That high school had been deemed necessary because that area was mostly undeveloped, and the land was dirt cheap. The thinking was that veterans of world war 2, only then returning from their years of sacrifice for the preservation of liberty, would be the most likely candidates for homes there, and the school was to accommodate their children, so the City Fathers had wisely purchased the property to have when needed.

Around the existing high school stood substantial homes - silent witnesses to the competence of those who had pioneered the City. On the Plan, those were gone. In their place, additions to the old high school spread out like a university campus.

City Hall (where this meeting was held), a lovely relic of a past era, was missing from the map. It was replaced by a "government center", which was shown in an area then occupied by hundreds of small homes.

The heart of the business district, situated at the waterfront, became a utopian dream of a marina - the businesses miraculously removed to outlying areas of the City, where small clumps of stores were surrounded by huge parking lots.

Someone asked what the reason was for all this transformation. The answer was almost mechanical: "We must have planning." WHY? the citizens wanted to know. "You don't want a pig farm next to you, do you?" was the response. Well, of course no one did. But none had been proposed, either. How it would happen that a pigfarm might be set down in the middle of an established city was never explained.

The year was 1948. Despite strong opposition from the majority citizens, despite growing fears about what would result from all this planning, despite an attempted recall of three of the members of the City Council (which, sadly, was unsuccessful by a slim margin), the Plan seemingly began to take on a life of its own, and The City was never the same.

About Thanksgiving time, it suddenly became 'necessary' to put new sewers in the downtown area. Main Street was blocked off, and merchants

who had already put in their stocks for Christmas, found themselves isolated from their customers, who had to park outside the business district to do their Christmas shopping. It was a long way to walk, especially going back uphill with arms full of packages, and many of their regular customers found it more convenient to shop at stores elsewhere, which had parking close by.

Several merchants closed their doors after the Holidays, and never opened them again. Some of the businesses moved to the planned "shopping centers".

Awaiting the pleasure of Congress and "federal funds", it was 20 years before the 'marina' became a reality. By then, most of the downtown stores stood empty, or were occupied by fortune tellers, shady promotional entrepreneurs, tea leaf readers, and similar enterprises.

And grass grew in the sidewalk cracks on Main Street.

(The rest of that story came to pass just before the Fourth of July, 1988. The evening TV news had dramatic pictures of that marina going up in flames and smoke. It was reported completely destroyed. So much for Planners' plans!)

The homes around the old high school (grand relics of a happier past, with their beveled glass windows and door lights, beautifully planted yards, and huge graceful old trees), and those little homes in the way of the "government center" were condemned and demolished.

Gradually, the former owners disappeared from their usual haunts. So many of these were old folks, who had lived there all their productive lives, close by schools and shopping. Most had paid off their mortgages, and were looking forward to their 'golden years', with only taxes to worry about. It was not possible for them to find housing they could afford for anything near what the government paid for their homes. Some went to live with their children, disrupting two families' lives. Some found apartments, and some just up and died of broken hearts, frustration, or sheer anger at being put out of their "own" property.

This was the beginning of a new era for California - and the rest of the world, though few knew it then.

This was the activation of the NRPB Plan developed during the Roosevelt era .

Resistance was minimal, because of the lack of knowledge about what was being done. The citizens in one area did not know that what was going on there was being repeated all over the country. The resistance the Planners met in the pilot areas was used by them as a lesson, to gain control in other areas.

There was a growing acceptance of the "planning idea". There was a growing body of opinion which was receptive to 'government' taking control of such matters. There was a growing belief that no one could 'live' in a one room house - unless it had been there like forever. Why the older one-room could be allowed and the other proposed structure not, was never explained. To an innocent, it seemed it should be the other way around. A new one-room house would surely be better than an old one!

Even a one BEDroom house was not to be countenanced, unless it had an arbitrary square footage. Now there had to be so many windows per room; the doors had to be a minimum height, and the ceilings, too. Then the rooms had to be so big; the bedroom couldn't open off the kitchen; the rafters had to be so far apart; there had to be so much yard area to so much house; so far back from the street, so far away from the lotline; and so on and on and on.

All these things added to the cost of a house, and the American dream moved that much further from reality for young people just starting life.

Then came the pressures for "urban renewal" and "modernizing the cities". Little houses from the past were in the path of the bulldozers everywhere - no matter that they were all the occupants could afford; no matter that there was no place for those who lived in them to go. Already planning and zoning had dried up most of the opportunity for replacement.

The inevitable result of all these interventions in the use of private property has now become a much larger problem - no homes for the young folks just starting out in life; no place for the oldsters to go, when the children move away, and their homes become too large for them; the emergence of the "street people", with the also inevitable 'necessity' for 'government' to 'solve' these problems.

The list of radical absurdities has grown exponentially. With each one accepted, new ridiculousities are concocted. They are made to seem so practical - no, desirable - that it would be considered quixotic to oppose them. It was all for our own good, you know.

Well, today, the birds have come home to roost. The way things are going, the birds may well be the only creatures with a home to come to.

I have no idea what that first home of ours would bring on the market today. I've heard that the "veteran's housing" which was built across the street from us a year or so later (which sold new for four, five, and six thousand dollars), was selling in the neighborhood of seventy thousand dollars several years ago. That's a nice neighborhood, if you can afford it. Certainly we who lived there after the war couldn't have.

Centralized planning has today all but replaced the historic American method of individual planning, which is basic to the liberties provided by our lawful government. Allowed to continue to its full potential, 'government' planning will - must - usurp all initiative for planning by the citizens.

Not just for property, but for the whole of their lives.

CONQUEST BY CONSENT - 63 - How to Subvert  
a Representative Government with the Consent of the Citizens.

The process we have shown in the last chapter is a clear example of a strategy we have found used repeatedly in this revolution.

Sometimes it seems that these mattoids never make mistakes. Not so. It can be very discouraging when attempts are made to stop their advances, which never seem to succeed, but there have been many times when they have made ill-advised moves, or have misjudged the strength of a redoubt. Several factors enter into the appearance they have of 'invincibility'.

Perhaps their basic strong point is that, from the beginning, they have known they were at war, and their targets did not. Another point working for them is that they have carefully planned their goals and objectives, and every move they make supports their purposes. The opposition, in contrast, has been forced to resist rather than take the offensive. Not realizing that a planned assault was being made, they have responded to such assaults without a coordinated plan, taking each new foray as it came.

Of great importance, now, are the facts that, one, the assault has gone so far that the battle is being waged today from positions of power within the government, and, two, is being financed with public funds.

When the revolutionaries make ill-advised moves, they simply take a step back, regroup, and move forward on an alternate route. This has been a repetitive strategy. It was used in meeting the solid opposition to The System in California, when a "replacement" was provided for the PPBS which was, in fact, the same System disguised as an "alternative". This is known as "one step back, two steps forward". When any advance rouses opposition strong enough that it threatens to become a political liability, a semblance of withdrawal is manufactured, and the targetted move is placed under camouflage. When the fire it caused is extinguished, it is put forward again, usually under a new identity, and is back on line.

This is a major strategy in denying the citizens of the United States the ability to defend their right of self-determination. It includes an apparent consent, for, although there is massive resistance when these moves are first made, when they are pulled back and taken through on a different tack they usually become fait accompli without the citizens knowing it was done. Ergo, no dissent. No dissent = consent. Selah.

This strategy was used again, when the recreated FRCs were renamed COGs, and dropped back over the States and local governments.

To examine the next step forward in the study of "how to subvert a representative government with the consent of the governed", we move to the State of Washington.

When then-Governor Dan Evans issued an Executive Order on 6 August, 1979, dividing Washington State into thirteen substate districts, he was not acting on his own (although from news accounts, one would think so). Preparations for that Order had been made long before, and only incidentally in Washington State. As a matter of fact, apparently in anticipation of the Nixon EO 11647, the preliminaries had been ongoing in every state for some time. Evans himself had joined with Governors of seven other States in 1978 to "discuss ways and means to create and coordinate substate redistricting" (newsclip). ALL of the 50 States were being so districted, and that long before the public or their elected representatives were informed of it.

In most cases, substate redistricting had been successfully kept low key, while the "supportive relationships" were being formed. When the time was ripe, the charismatic governor of California, who served on the ACIR, was given the dubious honor of making public the coming engagement.

"I have a dream," Ronald Reagan echoed another charismatic leader in his announcement:

"I have a dream... of government reform that will make possible efficiency and economy in government at a level never before realized."

That dream was of a level of governance not permitted by the United States Constitution.

For Reagan's "dream" was not his. Although he made a point in his announcement that it was not 'the impossible dream', he lied. It was, and the particular reform he envisioned in this dream was - substate redistricting. Substate redistricting is a euphemism for regionalizing.

Reagan's dream was the same dream disclosed by Rockefeller's General Education Board, in its "Occasional Paper Number One", promoted by the NRPB, and by John C Houlihan when he called for a merging of cities and counties back in 1965.

When the media reported Reagan's "dream", there was immediate and massive opposition in California, both official and unofficial. You see, the people of the pilot state for regional experimentation already had experienced three such levels of governance, and a fourth was then being fought bitterly. Those four areas encompassed the great majority of the citizens of that State, and there was strong resistance to any further deprecations of that nature.

In Washington State, under Dan Evans' EO, the State was arbitrarily divided into thirteen substate districts, with no prior notice. There was immediate reaction there too, but mainly from the elected County Commissioners. The issue was kept so low key that few citizens were even aware of the move, and those who were did not have the bitter experience Californians had had for comparison. But the Commissioners in Washington recognized the threat those districts held for them and their Office, and, almost to a man, they backed their concern with a mandated rejection - and they used 1313s own Washington Association of County Commissioners to send the message!

They thought they had achieved their objective when the FRCs were dissolved. They considered the Councils a dead issue and returned to business as usual. When the dust had settled, they learned about EO 12372, which mandated the States to create Councils of Government. There was not much concern among them about the COGS, because that Order did not disclose the hidden agenda, it allowed the Commissioners to determine the boundaries of the COGs, and they were led to believe that the COGs could be used by the Counties or not, as they chose.

The existence of the COGs was SO low key that it took seven phone calls to various offices in Olympia to elicit the information that even the Department there which designed the new substate Districts for the Counties reported it was not aware that they still existed. The only source which provided any substantive information was the office of the Puget Sound COG, which is also the only gungho COG in the State!

In most of the Counties, the COGs have been allowed to rest quietly, time bombs ticking away until they would be needed.

That "need" came to San Juan County in 1987.

The 20th of July, 1979 will go into the history books as the day of James Earl Carter's "Cabinet Massacre". On that day Jimmy played musical chairs with his "carefully selected" and presidentially-proclaimed "best men for the job" appointees. The Press had a field day reporting about that, before, during and after the fact.

On that same day a far more important official act of Jimmy Carter's took place, which to the best of my knowledge received absolutely no notice by that same Press.

The acceptance of the resignations Jimmy called for was duly noted in the Federal Register as required by law. Heed, now, what else was in the Register for that day, which The Press ignored. By the authority which Jimmy averred was vested in him "by the Constitution and statutes of the United States", Executive Order ± 11647 was revoked.

Some may well wonder what EO 11647 was about. For those who do not know, EO 11647 divided this nation into 10 'regions' superimposed over the States. It placed duly elected officials under an umbrella of Federal Regional Councils (FRCs) manned by appointed devotees of 1313, which, in turn, were responsible to an appointed federal regional "czar" in Washington. This EO was issued under the authority vested in Richard Milhaus Nixon "by the Constitution and statutes of the United States".

By a stroke of Nixon's pen the sovereign States of this nation became wards of the federal government, their elected officials minions of, and supplicants to, an appointed bureaucracy. Thus the impossible dream of the Elitists who had labored mightily to achieve this coup, was moved one giant step nearer to finalization. The Goal of one world of amalgamated nations and peoples demands the objective of an America with a more manageable structure than 50 sovereign States politically operating under elected officials who must answer to those who elect them.

So revocation of Nixon's EO which had transferred the elective authority to bureaucrats should have been worth noting. However, any positive reaction which might have resulted from that information would have been shortlived, for Jimmy then executed EO 12149 to replace 11647

"... in order to provide a structure for interagency and intergovernmental cooperation..."

Thus was established the new revised standard version of the Federal Regional Councils.

Why, then, the charade of take away, if there was a replacement ready? The answer to that is that Nixon's FRCs had received massive adverse reaction; Jimmy's FRCs were designed to relieve that pressure, although they now provided for the very first time, a total structure for intergovernmental cooperation. A replacement would be less apt to be subject to scrutiny than would modifications, which would invite comparison.

As Victor Jones (sometime collaborator on the National Resources Planning Board) told the ACIR at their hearing on substate redistricting in San Francisco in 1973:



"Only after the organization has jelled, and supportive relationships have been established, is it safe to leave the hard issues of physical planning, for the soft shoulders of social policy."

By 1979, the issues of physical planning were all but complete, and EO ± 12149 provided the supportive relationships to permit social planning to begin. A mechanism was provided in EO 12149 to ensure that the elected minions in the once-sovereign States would carry out the prescribed federal programs.

A special method was provided in 12149 for attention to "tribal, regional and local concerns" (and note which is last).

Jimmy's Regional Councils had a much broader base than Nixon's. In addition to hirelings from the various Cabinet departments (with special duties for the Office of Management and Budget), Jimmy's EO included ecological specialists, environmental advocates, business people, minorities and planners of all kinds as members of the Councils. The OMB was to establish policy, provide direction, and oversee the actions of the Councils.

Soft shoulders, indeed! More like soft in the head. Jimmy jumped the gun on this one, for his FRCs were intended to be in response to passage of the Public Works and Economic Development Act of 1979, which had run into a snag named Al Simpson, and was still in committee in Congress. So his Councils were without Congressional authority.

But more trouble was ahead for the FRCs, when, with the final version of the PWEDA'79, they moved out to change the face of America. The broader base and new stringencies which had been added raised the level of visibility of the FRCs, and elected officials and citizens alike once more became alarmed at the problems caused by the FRCs as they went into action. Several States began to look into the situation officially, but only Illinois followed through with a full joint legislative investigation, chaired by Senator George Ray Hudson.

When the Illinois hearings were completed, the Joint Committee issued a report which concluded that:

- \* there is a substantial body of evidence which indicates that the Federal Government is encroaching on the traditional rights, powers, and duties of the States and of local units of government;

- \* this intrusion by the Federal Government has not been accidental, but is part of a deliberate policy to increase federal power at the expense of the States and local governments;

- \* the regional trend is but one aspect of federal involvement in State and local matters;

- \* the Federal Government is using public monies, laws, programs, requirements and regulations to alter the structure of local and State governments;

- \* the Federal Regional Councils are a threat to the sovereignty of the fifty States, and constitute a new structure

which provides for the merger of the fifty States into ten regional units of governance.

The Illinois Report also pointed out that, prior to the push for regionalizing, there were less than 100 federal aid programs (at a cost of less than 2.2 billion dollars annually), and that at the time of those hearings, the number of aid programs had zoomed to more than a thousand (at the astronomical cost of more than 85 billion per year!). This increase, according to the Joint Committee, was due to the enlarged federal dominance in State and local affairs.

The Report concluded with a recommendation that the State of Illinois should create a permanent Legislative Committee on State Sovereignty, which would be assigned the duties of investigating such Federal intrusions, and making recommendations to the State Legislature on ways of guarding the sovereign rights, powers and duties of the State. It also recommended that the Illinois delegation to the federal Congress should introduce legislation to abolish the FRCs. (Neither of these recommendations was implemented.)

That Report, and citizen and official concerns throughout the States sparked an antagonism to the FRCs which culminated in a Reagan administration's strategy to take the heat off the Councils in particular, and the regional movement in general. In his EO # 12407 Reagan rescinded the EO which recreated the FRCs in 1979, just as Jimmy Carter did with EO 11647.

In 12407, Reagan pointed out that he was merely "eliminating a mechanism... which was no longer needed". But that did not mean that the FRC System no longer existed. Far too much hung on continuance of the structure, and far too much time, energy, money and planning were involved in setting up the system, to voluntarily dissolve it now. AND it was an essential cog in the revolutionary plan.

No! Read Reagan's statement again. He was merely "eliminating a mechanism" which was no longer needed. The mechanism of the FRCs was no longer needed - had, in fact, become a liability. What Reagan did NOT report was that in anticipation of the need to quiet the clamor against the FRCs by eliminating this "mechanism", he had issued EO # 12372 the year before, creating another "mechanism" to keep all the functions of the FRCs without the stigma which they had accrued. Allowing a year to put this new "mechanism" in place without having to deal with opposition was undoubtedly planned.

The new "mechanism" was to be known as "Councils of Government". They were to be formed voluntarily by the States (under penalty) and would develop other channels to receive federal directives, under penalty of loss of federal funds.

This strategy shows how you can have your cake and eat it too! It also clearly shows one of the processes which are amenable to effective resistance.

CONQUEST BY CONSENT - 65 - Group Dynamics  
As a Subversive Process

Driving east from Sacramento, California on Highway 50, a large sign greeted the traveler on the road to Nevada, which read, "Welcome to Beautiful South Lake Tahoe, where Freedom Ends, and Dictatorship Begins". Apparently placed there by citizens of the area, the sign was an insistent reminder of the unrelenting attack on the Constitutional government of these United States.

The overlay government at Tahoe was imposed by government edict, with the complicity of special interest groups, the legislatures of California and Nevada, the Offices of the Governors of both States, the United States Congress, and the Resident of the White House. The Tahoe Regional Area Plan (known by its acronym, TRAP, until its progenitors realized the tool they had given to opponents, when it was changed to Tahoe Regional Plan Area - TRPA!) was created by a longterm effort, operating through legal channels.

TRAP was about 10 years in the making, before the outline of the Plan became generally recognized. Once it had been, it was met with strong resistance from both the citizens and the local officials, but its development continued despite that fact, until today, by court edict, the protections of the Constitutions of neither State nor Federal governments any longer apply to that area.

Much has been made of the fact that the TRAP had been created through legitimate avenues - even though it was done against the will of the citizens and the local officials.

During the Bicentennial year of the Declaration of Independence, a movement began to obtain a similar distinction for the rest of El Dorado County, but to bypass the legal channels. This time, it was planned to obtain direct consent from the citizens, by means of a strategy known as "group dynamics".

In August of 1976, representatives of a Chicago-based group contacted officials in the local branch of the Bank of America, to obtain sponsorship for a series of "town meetings" to be held in El Dorado. It wasn't surprising that they were successful, since the Bank of America had been a prime sponsor of the parent organization, the Institute for Cultural Affairs (ICA).

ICA's main thrust is creation of a "new man", who will change the original goals of this nation, to permit its integration in a worldwide social order. And so, on 18 June, 1977, a first step was taken to lead the rest of El Dorado into the same kind of controls as those over Tahoe, only this time, they were to be self-imposed, by the citizens.

A slick brochure was handed to each of the participants in the "town meeting" as they arrived. It showed a copy of a "social process chart", on which all human concerns fit into little boxes, as a result of communal decision. Around the room, there were large easels, with pads of brown wrapping paper standing on them. The meeting opened with an announcement of an already-determined purpose, and a schedule for 'discussion'.

Those attending were to divide into small groups, each with a 'leader'. Each group was to discuss one of a set of projects, while the leader wrote down all suggestions on the brown paper, in large letters, so all could see. After a determined period, each circle was to move to the next, and

take up the subject discussed in it, adding any new suggestions. This was to be repeated, until everyone had participated in each circle.

At that point, the groups were reunited as a whole, and the results of the circle suggestions were read to them. Those results then became the basis for future 'town meetings'.

The comparative handful of citizens who attended that 'town meeting' surely did not express the desires of the majority in that county, as they opted for more and more controls over their lives, under the direction of the 'facilitators' (as the group leaders are called).

The one suggested concern that elected representatives should be making such decisions, was passed over as though it was never made.

Can it legitimately be suggested as 'cause and effect', that the rest of El Dorado County is now under most of the same stringent controls which prompted erection of that sign?

On 25 May, 1988, the business community of Eastsound, on Orcas Island, in San Juan County, Washington State, answered a call to a meeting at the Orcas Center building, "to pursue the feasibility of establishing a Business Improvement Area, a tax district, for Eastsound...", according to an announcement in a local paper.

When the citizens who answered that Call arrived at the Center, they were given a short progress report on the organizing activity of a group desiring to create the "Business Improvement Area" (BIA).

A "community planner" from Seattle's King County was introduced, and the implication was that this Planner would be (if she wasn't already) the resource person for the creation of the BIA. No mention was made of the cost of her services, or even why a local volunteer group would feel the need for them.

Then the facilitators of the three already created committees were introduced, and gave reports on their separate deliberations, conducted at interim meetings of participants in the decision-making meeting, after the determination by that original group to "pursue a BIA".

After the reports of the facilitators, the assemblage at the Center was asked to form in three equal groups to discuss three predetermined objectives - one, structure; one, budget; and one, revenue - each being led by the three local citizens who had been chosen previously to head the committees - one of whom was CEO of a local bank.

There were wooden easels for each group, holding large sheets of brown paper ready to record the suggestions from each circle. After a specified time, each circle was to move up to the next, and repeat the discussion, and add to the wrapping paper record, and etc. and etc.

What was going on, in both these cases, was an exercise in group dynamics. Group dynamics is a "scientific method" for bringing about 'consensus' in an otherwise diverse gathering of people, without the knowledge of the participants of what was really being done.

"Group dynamics" was a strategy devised by a Rumanian immigrant who came to America in the early 1920s. Although he did not become a citizen of the United States until 1935, he was permitted to perform his experiments in a public school while still an alien.

J. L. Moreno and his work have been widely cited in professional journals, and his techniques strongly promoted by educationists and 'social scientists'. His 'group dynamics' was the first rounded system of behavioral modification used on a grand scale, and it is still in use today, as the two examples cited here demonstrate. Moreno's original strategy was called "sociometry", and group dynamics is based on

sociometric principles.

In his book "Who Shall Survive?" Moreno described his work as "a creative revolution" and claimed it could be used for "indoctrination of any set of values - religious, communistic, or fascistic - " From his original premise stem such later strategies as "sensitivity training" and Delphi, as well as group dynamics.

While Moreno acknowledged a debt to Karl Marx in development of sociometry, he never apparently mentioned Pavlov, to whom his debt was far larger. Advocates of his strategies would prefer that no connection between these three be recognized - for obvious reasons.

In a textbook written for prospective teachers of public schools, the purpose of Moreno's system is baldly stated:

"... the educational psychodrama is concerned with the control and direction of normal behavior towards desired goals... it is a group process, by which we seek to modify existing behavior..."\* (emphasis added)

Other official sources make it clear that the reason for modifying behavior is to shape the future by molding the mind - particularly the minds of children.

One man to whom Moreno gave top credit for the success of his strategies was Dr. William Alanson White ("father" of the "mental health" movement). It was at a memorial service for White that G.B.Chisholm made his historic remarks on child training and mental health, concerning "...the poisonous certainties fed us by our parents", such as concepts of right and wrong, and the "moral chains" such ideas place on people.

It is evident today that a very large segment of our population have 1) not been fed those poisonous certainties by their parents or 2) the certainties did not "take", or 3) somewhere along the way their brains have been washed with the help of such luminaries as Pavlov and/or Moreno.

How else can so many people be so unconcerned about the abuses which are becoming a dominant factor in American life today?

Recommended Reading:

"Psychodrama and Sociodrama in American Education" by Robert Haas.

"Group Dynamics - Research and Theory" - Cartwright/Zander (Textbook) Harper and Row, 1953/60.

CONQUEST BY CONSENT - 66 - "The Whole Thing  
is for Planning"

Washington State's San Juan County consists of a group of islands in northern Puget Sound. In the original FRC setup, San Juan formed a Council with two northwest mainland counties. Skagit and Whatcom are just across the Sound, but by ferry and car it is a full day's journey to make a round trip.

When the shakeup in Washington State came over the FRCs, San Juan Commissioners elected to be a single county COG. Once created, the COG's very existence was all but forgotten in most of the State. Only the major COG involving Seattle and environs became an active 1313 pipeline, under the direction of a professional 1313 "manager".

The population of the San Juan Islands is an interesting study in itself. In the summer, the tourists all but take over. After Labor Day, the islands have the appearance of almost any small community.

There are some residents who have lived there all their lives, and many of those are in their seventies and eighties. Young people see no future for themselves on the islands, and most of them leave early to seek their fortunes elsewhere. Some of those have made their fortunes, and returned to one or another of the islands to retire.

Some residents who came as tourists thought they had found a place to escape from any of a number of problems which mainstream America knows only too well, and returned to the islands to live.

The New Agers have had a foothold on Orcas Island for many years, and recently a flood of new disciples seeking to commune with nature have filtered in. There is a Catholic nunnery on Shaw Island. Indians have begun to claim the islands as a homeland, although few have remained resident through the years.

It is said there are more millionaires in the San Juans than on any comparable size piece of real estate in the country, but many of these are only summer residents. Most of the islanders belong to the great middle class, the direct object of major attention from the revolutionaries. There is a hardnosed environmental group whose composition seems to include some of most of the other identifiable segments. There is an apparent professional leadership of the environmental movement.

The Planners moved in about ten years ago. And nothing has been the same since.

San Juan has had its problems with planning. The first tentative comprehensive plan (comp plan) tried to avoid confrontation, offering only what the Planners apparently thought would be acceptable to the community. Alas for Planning! The comp plan seemed to please no one - not even the Planners. That original Plan was modified piecemeal over the years, adding a restriction here, another there, until it began to take on a standard appearance.

There was an unusual difficulty with planning for San Juan County, because of the distance between the islands. The County seat in Friday Harbor is an hour or more ferry trip from any of the other main islands, and ferries are few and far between. There are some islands which are not served by the ferry at all, and recently the ferries have been inadequate for any of them.

The real problem with central planning on the islands is that there is

no general agreement as to the role of the Planners in island life, and minimal understanding among the citizens of the planning idea. There is a separate "planning review board" on Orcas, composed of activist volunteers, which is supposed to supply the County Planning Commission with an overview of the 'desires of the residents' there as regards government planning. In point of fact, the only citizens whose desires it really represents are those on the Board, who are also usually the only citizens present at their meetings.

There have been major confrontations over 'planning' between individual citizens and the Planners, as well as between the Planners and the general public they supposedly serve. It takes like forever to get plans for private property approved (in one case, seven years, another has been ongoing for five years and counting). In the last few years these confrontations have caused citizens financial losses in the millions, and heartbreaks by the score. These people have lost the edge off their dreams, uncounted hours of time, and a visible slice of their liberties.

So it was not surprising that the Planners and the Commissioners ran into difficulty in planning the area around the San Juan airport. After years of indecision and attempts at bargaining, the owners of that property remained adamant in their desire to develop it, and the County refused to make concessions which contravened The Plan.

Enter the Hegelian dialectic.

A situation exists where The System demands the presence of a decision-making body which will not be swayed by local property owners. A COG is present, but not in force. All that is needed to activate it is that it be manned. The representative government in this case is unable to obtain consent to their Plan. An administrative body is not bound by the same laws and regulations which hold for elected bodies. The solution? Man the COG, and the airport problem will be solved through administrative mandate, with no recourse.

So, late in 1987, one Commissioner took it upon himself to put San Juan County under the COG umbrella. Rushing to achieve his objective, that Commissioner, without a hearing on his intended action, made the appointments necessary to activate the COG. As word of his intent got out, an attempt was made to warn him of the consequences of his proposed action. He refused to hear the citizen petition against it, and defended his position with a statement to the local paper that "The whole thing is for planning". And so it was.

And San Juan County is now an American Soviet.

It is not generally recognized that centralized planning by government as now being implemented in the United States was first practiced in the Soviet Union. The "soviet system" was the means devised in Lenin's time to control the Russian people, and keep them in line by control of all aspects of their economic, political and social activity, through locally situated toadies for the central establishment.

While the first Russian Soviet "five year plan" was still on the drawing board, radicals in this country began preparing to institute that system here.

Their nefarious plot was carried on without official sanction, at first. "Volunteer" planning groups sprang up in the 20s, gungho for regionalization of "standard metropolitan areas". The area for the New York/New Jersey border was a pilot, rapidly followed by others around Philadelphia, Chicago, and many smaller efforts as well.

Public knowledge of the extent to which soviet-minded Americans had

penetrated the federal government did not come until the 1940s, when Congress was asked to approve the scheme of the National Resources Planning Board. By rejecting that Plan, Congress believed they had settled the matter. But, again, it was one step back, and then two steps forward.

With the creation of the federal Advisory Commission on Intergovernmental Relations, another Congress gave the green light to activation of The Plan. Ever since, the ACIR has had plans for you. And it has had a lot of help.

In 1964, ACIR issued its publication # M-17, which recommended "interagency coordination" for a "unified (federal) urban development policy". This went far beyond ACIRs mandated duties of policing the Executive Department. M-17 was the first major ACIR policy paper toward establishing a system of soviets in the United States, and ACIR has led the way ever since.

In 1963, the Department of Agriculture, instead of its usual report, issued an update of the NRPB Plan, urging implementation of it.

In 1965, Lyndon Johnson railroaded the Public Works and Economic Development Act (PWEDA) through Congress. As originally submitted, this bill was a blank check for full implementation of the NRPB Plan. This the Congress would not accept, but, in passing the rest of the Act, authority was delegated (unConstitutionally) for the Executive to deal directly with local governments. Regional Councils were provided to channel federal directives into the local districts, and for local acceptance of the directives.

As with ACIR, PWEDA was 'sold' as a means of breaking up the power which had been accumulating in Washington D.C. Instead, PWEDA provided 'the carrot and the stick' to assure that local governments would bow to federal mandates. (The carrot = 'federal funds'; the stick = withholding those funds)

While ACIR led the way, the actual breach of faith here was committed by Executive Order # 11386, which established a Federal Advisory Council to control the FRCs. Gerald Ford added a mandate for State compliance with federal policies and programs.

There was one small detail about Carter's EO 12149, which we saved to fit in here, because it is of the essence in the matter of the COGs. This EO mandates the FRCs to cooperate with State administrative and regional agencies. FRCs now are COGs. ERGO: COGs are so mandated. There is no such mandate for representative bodies. So when the San Juan Commissioner activated the COG there to 'solve' the airport problem, he put jurisdiction of that problem in the other Washington. THAT is how the dispute will be settled.

But this is one small part of the COG issue. The whole thing is that the COGs are essential to the controls demanded by central planning, and they flaunt the intent of the Constitution.

Make no mistake about it. That Commissioner never spoke truer than when he said the whole thing is for planning.

Central planning.

Economic planning by "experts".

SOVIET style planning.

Recommended Reading:

"A Place to Live", 1963 Report, Federal Department of Agriculture.



# section VI

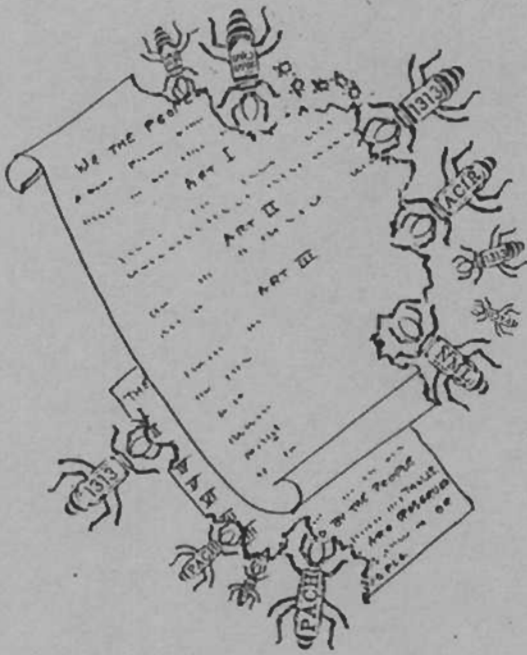

## The Ultimate Weapon

ch:	pa:
68 The Goal Setting Process	VI - 1
69 Forbidden Territory	VI - 3
70 "The Battle for the Mind"	VI - 7
71 Involuntary Servitude	VI - 10
72 Cybernetics	VI - 13
73 The Smoking Gun	VI - 16
74 Removing the Lid on Spending	VI - 10
75 Buggy Whips and Space Technology	VI - 22
76 The Last Hurrah	VI - 25
77 Mental Trojan Horse	VI - 28
78 Unwitting Assistants	VI - 31
79 The 5-5-5 Project	VI - 34
80 The Shibboleth of Local Control	VI - 36
81 Brainwashing	VI - 39
82 Secret Agenda	VI - 42
83 The Pragmatic Application of Deceit	VI - 45

## THE ULTIMATE WEAPON - 68 - The Goal-Setting Process

When schools across the country started out in the late 60s to set "goals and objectives", few voices were raised to question the intent.

Parents everywhere were disturbed over the many programs which were being inserted in the school curriculum, steadily departing from the basic education they wanted for their children. Some parents were worn out by the hassle of trying to protect their children from premature disclosures about sex, and the equally alarming "behavior modification". Many had come to accept that the school people did not want to hear their concerns.

So, when they were asked to help their districts set new goals, they jumped at the chance to have a voice on the "inside". They eagerly accepted appointment to the "Blue Ribbon Committees" which were to "work out the solutions", and set "new goals" for education.

If those parents had been aware that the "goal setting process" was devised by the Planners, to silence dissent, NOT to obtain "input", they could have been saved the time they willingly gave, and the heartbreak of the disappointment which followed.

What they had been tricked into, was a form of "participatory democracy". By getting involved in the 'process', they opened themselves to being manipulated into modifying their clearly perceived personal goals, to reach a "consensus" with a majority of the minority who participated.

"CONSENSUS" NULLIFIES INDIVIDUAL GOALS.

The participants in the Blue Ribbon Committees had lent their personal credibility to the product which issued from those Commissions, without regard to the commitment which had prompted them to accept appointment.

THE GOAL-SETTING PROCESS EFFECTIVELY TAKES THE DECISION-MAKING CAPABILITY FROM THE PARTICIPANTS IN THESE COMMITTEES AND COMMISSIONS, AND PLACES IT IN THE HANDS OF THE PLANNERS WHO CAUSED THE PROBLEMS IN THE FIRST PLACE.

It took practically no time for some of the parents to question the value of this new tactic. One mother protested,

"We were asked to help in getting the schools to direct their programs toward our goals for our children, but all the while, we were being pressured to accept things we didn't want at all..."

Another explained,

"Those of us who served on these "Blue Ribbon Commissions" worked long and hard to set goals we could all agree on, and felt we had succeeded. When the Goals were printed for the public, however, our names were on the document, but that was about all that was left of our work.

"We were left holding the responsibility for what was none of our doing."

In at least one California district the parents' goals were printed on a single page of the Commission 'Report', followed by two and a half pages of additional goals, written by the school superintendent!

When all the Goals for California school districts were finalized, there was little to distinguish one school's goals from any other. They

could have been following a blueprint. In no case was there evidence that the parents were told that the "goal-setting process" was part of a larger program, and that the process was more important than the goals.

Disclosure of the existence of the Planning, Programming and Budgeting System provided knowledge of the "larger program", of which the goal-setting was a part.

The goal-setting and the PPBS are components of the least understood, most strongly promoted, and expensively implemented program ever initiated in this country. It is also the only program which has been a consistent failure in obtaining its stated objectives which has continued to receive solid support by all its proponents.

"Participatory democracy" was what the Frontier Thinkers of the New Deal era called the goal-setting process, and it is a far cry from the kind of representation guaranteed by the national Constitution. The New Dealers called for "citizens advisory groups, working with elected and administrative officials" thus (they said) opening up "opportunities for a large number of citizens to participate in government (directly)". At the same time, and with straight faces, they could call for "true democracy" - which they said had nothing to do with majority rule, but which could operate through the process of "consensus - agreement reached through discussions in small groups."

Though at first glance these may seem contradictory concepts, they really are not. The "large numbers of citizens" are, in fact, a small group compared to the citizenry eligible to vote free of suasion other than fact and logic. The "large number" in citizen participatory groups, thus enabled to make the decisions for the entire community, were without precedent - and are without constitutional authority.

By means of this program, unless it is stopped - and that soon - these United States will become one vast prison for everyone living within their confines. That threat of a "prison nation" is very real, unless and until the still sovereign citizens regain control of the processes of their government by reviving the methods provided in the Constitution.

The concept of outside interference with private lives is so alien to American thought that most citizens of this nation still find it repugnant, despite the contrived situations which, increasingly, encourage it, as in central planning for private property.

Extended to external control of personal decision making, as in psychological warfare ("psywar"), waged to break down morals and values, such interference becomes unbelievable. It violates the most priceless possession with which man is endowed - his mind.

Americans were shocked after the Korean "police action" by revelations that a sizeable contingent of their captured sons "elected" to stay with their captors, instead of coming home. Because of the size of that mass defection, and because, at that time, there was still a substantive remnant of political control in the hands of the sovereign citizen, the cause of this unusual situation had to be disclosed. Enough of the facts were brought out that it was possible for the public to understand that systematic erasure of the loyalties of these soldiers had been effected - loyalty to both family and country - by psychopolitical operatives. They were, in fact, "brainwashed".

No more was revealed in the official releases than was necessary to answer the insistent demand from families and other concerned citizens. There was no public mention of the then-established fact that the same techniques as were used on American servicemen in Korea, had been used ten years before to facilitate the communist takeover of China.

The public press was not inspired to make a Roman holiday of a search for that 'big story'. It remained for Edward Hunter, the man who coined the word "brainwashing", to expose the facts about that early use of The System. In a carefully documented book, titled "Brainwashing in Red China", Hunter had shown the extension of the techniques used on captive Americans in Korea, as applied to an entire nation, in China.

Unfortunately, his book never made it to the best-seller lists, and it was read by a comparative few. Unfortunately, because today those who read that book can see the same techniques as were activated to conquer China now being used on the population of the United States. Unfortunately, because without such a reference point a casual observer cannot possibly relate what he sees 'happening' here, in America, to a systematic, scientific use of mind control. Unfortunately, because without the brainwashing connection, it is a practical impossibility to interrupt the process. With Edward Hunter's testimony about the "brainwashing" techniques used in China for comparison, the veriest tyro is able to recognize the pattern of The System, as it is being used in this country.

Twenty years after Hunter reported what was being done in China; an interim of another twenty years during which elements of The System were perfected and installed in the structure of the American government; and twenty more after the Planning, Programming and Budgeting System was exposed in its true nature, and its implementation in the educational arena, there is still almost universal ignorance of its existence. If Americans knew what really 'happened' in China, they would have less trouble understanding what is being done in the United States.

There is almost universal official resistance to a re-examination of PPBS and its failures - and potential. If our officials today knew what Ed

Hunter knew then, most of them would surely be "viewing with alarm", at least, and maybe even calling for heads to roll.

The almost universal unconcern about The System has to be due to lack of understanding of its capabilities.

Even those who have enough information about The System to be concerned about it being in our government, cannot seem to understand just how it operates.

The programs are confused with the process. Programs which seem to contain PPB components, are actually being achieved by PPB techniques. While it is understandable that the one could be mistaken for the other, unless The System is made visible, there is minimal hope that it can be deactivated. It really isn't all that complicated.

The PPBS (by whatever name it is presently being called) is an adaptation of the goal-seeking servo-mechanism of the space program, applied to the human mind. In its application in mind control, the stimulus-response theories of Pavlov are used to achieve its goal. Basically, the Goal is predetermined, and a program is designed to reach that goal.

The essential elements of a PPBS are:

- 1) A predetermined Goal;
- 2) A basic unit to direct to that Goal;
- 3) Objectives
- 4) A Program
- 5) Information (data)
- 6) Evaluation
- 7) Cycling and/or Recycling
- 8) Re-evaluation

The Goal is set for any given subject as the basic unit, to be manipulated as needed to reach the Goal; a Program is planned to fulfill that mission; all available data are entered into the Program, to determine Objectives, which are set as part of the Program; on reaching an Objective, Evaluation determines whether the trajectory is maintained, and the mission is still on target; if it is, the controls remain until it reaches the Goal; if it is not, the controls are modified, and the subject is recycled to that same Objective, until it is met, and sends the subject on to the Goal.

Budgeting and Accounting are NOT essential adjuncts to the Basic Process, but are a lock-in factor in a defined Program.

It is important to know that all these components may be present, yet not visible, and the PPBS still operative. This is patently the case with use of this psychological technique for mass application.

An essential question requires an answer:

"If this is being done in this country, WHO IS DOING IT?"

Abundant evidence places a large part of the responsibility on the educational establishment, beginning as far back as the early part of this century.

Unelected people both in and outside the government have provided the breeding grounds and the climate for growth of the germ of the System.

During the twenties, data collection for systems functions was begun.

In the 1930s, the Moscow Summer Schools issued the Call for the

teachers of America to use psychopolitics in their daily work, and the embryo "planning movement" picked up the Cause of systematic control and began constructing the channels through which it would operate.

When the Armed Services were melded into the Defense Department in 1947, by the National Security (sic) Act (NSA-47), a special, super-secret unit was created, to develop the techniques of The System. This unit, in turn, created research and development units outside the government, to aid in this process. NSA-47 restructured all military departments into a single, unified, command - the essential format for an operative PPB System.

\* By 1958, unknown to all but The Elitists, The System was "GO", and Congress, encouraged by the President's Commission on Reorganization of the Executive Department, passed a resolution (H.R. 8002) which made it possible to operate The System in the government. Reorganization of the Executive was an essential element of an operational System, just as the reorganization of the military had been.

\* In 1960, the "extended census" was initiated, ostensibly to obtain updated data on the "social health" of the nation. Actually, the data was to be used to feed the computers the information needed to keep all elements of the revolutionary Programs on target.

\* In 1961, John Kennedy ordered The System to be installed in the military frame provided by NSA-47. The Vietnam war was operated by systems analysts and computer experts, while seasoned military personnel cooled their heels, and were stone-walled out of their responsibility to take charge.

\* In 1963, extensive efforts were begun to provide "data banks" as repositories for the intelligence needed to operate The System.

\* In 1964, Lyndon Johnson ordered The System installed throughout the now-restructured Executive Department.

\* In 1965, two landmark bills were approved by Congress, one for state and local governments, and one for education, which provided funding for local implementation of The System. The first was the infamous PWEDA (Public Works and Economic Development Act). This Act provided "federal funds" to step up the regional takeover of local governments, which had run into trouble, because of citizen resistance. At the same time, sparked by the Elementary and Secondary Education Act of 1965, federal and state operatives in education were preparing educational planners to install and operate it in the schools.

The Strategy of PWEDA and ESEA was "the carrot and the stick". Local officials, dazzled by all that money, and beset by drains on local tax bases due to demands from State and federal 'mandated' programs, went for it - ignoring the fact that new "sticks" went with this "free" money.

It was in the mid50s, too, that insistent pressures began to replace old, small county office buildings with new, large "Government centers" - each with generous space for "data processing".

In the late 60s, Constitutional revision began in the States, accompanied, or followed, by reorganization of the Governor's offices, following the pattern established in the federal Executive Office. This 'reorganization', too, created the single line of command necessary for the management and control system.

Also in the late 60s, some of Rockefeller's 1313 agencies, operating through George Washington University, targetted five compliant states, five cities and five counties as pilot projects for installation of The System within the regional structure of the entire country.

Public Works & Economic Development Act  
VI - 5

P W E D A

The System requires a single decision-making unit, to be functional. There was no way our Constitutional government could be used for Systems purposes. This is why our entire political system has been restructured through the regional planning process and Executive reorganization, to provide the channels which allow the System to be activated.

In the Budget Act of 1921, Congress had surrendered its Constitutional responsibility for the Budget to the Executive. In the late 60s, the Bureau of the Budget (now in the Executive Office) was designated as the "single head" of the System, renamed the Office of Management and Budget, and organized to begin the management and control of this entire nation.

Evidence suggests:

- \* that there has been knowledgeable participation on the part of elected and appointed officials, thinktanks, hirelings in and out of government, school personnel, and the news media, in keeping The System under wraps;

- \* that this was deliberate obfuscation, to avoid premature disclosure, which would have certainly activated a massive counter-revolution;

- \* that some elected officials knew of the intent to install The System, and cooperated;

- \* that most legislators were totally unaware of any of this;

- \* that school personnel, whether knowledgeable or not, collaborated in preparing future citizens of this country to be willing subjects of a managed and controlled world.

Recommended reading:

"Lectures on Conditioned Reflex" - Ivan Pavlov, (Trans.by Gantt) International Publishers 1928

"Brainwashing in Red China" - Edward Hunter, Vanguard Press, 1951

"Present at the Creation" - Dean Acheson, W.W.Norton publishers, 1969

"Psychology in a World Emergency" - Lectures, University of Pittsburg Press, 1952

U.S.News and World Report, "Will Computers Run Wars of the Future?", 23 April 1962.

"A Metropolitan Area Fact Bank for the Greater Los Angeles Area", prepared for the Ford Foundation, 1963.

"The 5-5-5 Project - Implementing PPB in States, Cities and Counties"; State and Local Finance Project; GWU 1969

Various publications on Systems from RAND Corporation.

THE ULTIMATE WEAPON - 70 - "The Battle for the Mind"

"Politicians, priests and psychiatrists often face the same problem: how to find the most rapid and permanent means of changing a man's beliefs... ..Great Britain and the U.S.A. therefor find themselves at last obliged to study seriously those specialized forms of neurophysiological research which have been cultivated with such intensity by the Russians since the Revolution, and have helped them to perfect the methods now popularly known as "brainwashing" or "thought control"..." (emphasis added)

Those words are psychiatrist William Sargant's opening salvo in a 1957 book, "The Battle for the Mind", originally produced by a major publishing company, reissued in the 1970s by Greenwood Press in paperback.

In "The Battle for the Mind", Dr Sargant reveals the X-factor in the political equation, without which there can be no identification of the process by which world revolution has been advanced. Without that identification, no effective constraint can be placed on the conspirators who are masterminding the steps into what has been called a New World Order - now designated "The New International Economic Order" (NIEO) by its progenitors.

That X-factor is the use of mind control as a tool to direct "the decision-making process". Disregarding all protest, politicians are incrementally altering all the institutions by which men are governed, and that, by dictionary definition, is revolution. Priests and pastors have acquiesced in the restructure of religious institutions and practices.

That is a revolution within established religious practices.

Psychiatrists have led the assaults on the minds of men, for the purpose of modifying the behavior of mankind. And THAT is revolution.

As Dr Sargant describes this latter engagement:

"The politico-religious struggle for the mind of man may well be won by whoever becomes most conversant with the ... functions of the mind, and is readiest tomake use of the knowledge gained."

The quiet conquest of the mind has been an unrecognized adjunct to the politico-religious penetrations, almost from the initiation of the revolution.

Even had Dr. Sargant's little book found its way to the 'best seller' list when it first appeared, it's unlikely that your 'average American' (if there is such a thing) would have placed much credence in the content. There simply was not enough visible evidence, in 1957, to support the thought that 'the government'\* could - or would - attempt to obtain involuntary consent to an undisclosed goal, by practicing "brainwashing" on an unsuspecting citizenry. There was minimal evidence then (and that not generally visible), that the strategies of psychopolitics had been ongoing in an official capacity, for many years.

One can only speculate why "The Battle for the Mind" was produced, and then not promoted through the usual channels. Since Dr Sargant was subsidized by the Rockefeller Foundation for a "valuable year" at Harvard University, "observing the teaching and treatment of ... modern techniques

New International <sup>VI-7</sup> Economic Order



of conversion and brainwashing", (quote, Dr Sargent, 'Foreword', from the book), and since his book was published by an "inside" firm, it would seem such promotion would have been a foregone conclusion.

Speculation about that could include a possibility that this book was never intended for the "average American"; that there was a 'need' for a textbook, easily obtainable and readable, for those already in positions where they could be called upon to collaborate in official activation of the strategies which, even then, had reached a demonstrable level of effectiveness. As we report in another chapter, it was Herb Philbrick (I Led Three Lives") who first brought to public attention that this strategy was being applied in these United States. Philbrick reported that he couldn't find a single textbook on the subject, in 1954.

Publication of a textbook, which could be identified as a tool to train government employees in psychopolitical strategies, would, almost surely, have raised an eyebrow or two, in 1957. But a "resource" book for general consumption could be promoted to those in government who lacked the expertise needed to perform there as psychopolitical agents, while its apparent non-relativity, and the "silent treatment" would make it invisible to the general public and busybodies in Congress.

In view of the record of duplicity which has been documented by numerous researchers into this quiet revolution, any reasonable person could accept a causal relationship between seemingly unrelated incidents, and the results they support, with or without proof.

So in the case of this book. The scenario suggested above was used to promote a blueprint for penetration of the public schools, devised and disseminated by the Educational Policies Commission 15 years earlier. As you will find in our chapter "Goals for Americans", this strategy was also used in promoting the the product of the "President's Commission on National Goals". so it is not illogical to assume that it might have been used on this occasion.

Be that as it may, had general knowledge of the content of "The Battle for the Mind" been available at the time the management and control system became visible, it would most certainly have made the case for validity of the charges citizens made against the Planning, Programming and Budgeting System.

"The Battle for the Mind" is clearly and concisely written. Its subject is addressed by a qualified 'expert', and the product is totally understandable. There are also a number of bonuses - peripherals not directly involved in the main theme, but adjuncts to it. One such is an outline in Sargent's book of the strategy now known as "The Politics of Change".

By including historic examples of 'operant conditioning', the case for practical application of psychopolitics as an instrument for involuntary change, is made plausible. The important difference between previous and proposed use of conditioning (which is not mentioned in the book), is that, formerly, application was haphazard, unorganized, and without knowing how it worked. Today, the strategies have been developed into an "art and science". They are being applied systematically, with predictable results, AND now, with the organization of 'government'.

Any attempt to correct the "problems of today", without taking into account the existence and use of this method of controlling, not just the beliefs of the citizens, but their reactions, is doomed. Just knowing how the System works is not enough. Whatever counter measures are mounted MUST utilize some of the capabilities of the System, or, as Dr. Sargent stated,

the victory will go to those who are using it.

Anything less than meeting strategy with strategy is like trying to put out a forest fire with a glass of water.

THIS is why we are losing. The revolutionaries achieve THEIR objectives by creating conditioned acceptance. WE try to fight back with reason, logic and fact.

There's no contest!

Addendum:

'the government' - if there is a single word most damaged by altered concept, this has to be it. In a country such as ours, with a written Constitution, that document, laws made pursuant to it, and the departments they establish, are the government. Today's dictionaries have copious explanations of 'government' referring to the people operating the government machinery. Today, even some who should know better blame 'the government' for all the ills plaguing the country, when, in fact, it is the "scientific bureaucracy", working within government departments to effect their revolution, which should be faulted.

Recommended Reading:

"The Battle for the Mind" William Sargant, Harper and Row, 1957

## THE ULTIMATE WEAPON - 71 - Involuntary Servitude

With the increase in the problems experienced by teenagers today - drug abuse, promiscuity, isolation from family, violence, suicide - Americans are becoming aware that there has been a damage to tender young minds so universal that it could only stem from one source - the public schools.

Some of the evidence of damage is overt - inability of so many students to read and write; failure of the schools to provide basic historical fact; the elimination of true literature; the intrusion into familial areas.

But there is a damage which is not so visible. and, consequently, not receiving the attention it deserves. It involves elimination of the boundary of self.

It is not just competence, nor racial, sexual, religious and national characteristics which the would-be masters of the world intend to neuter. It is the individual, himself. This objective is well on its way to accomplishment.

Throughout their years in school, children are imbued with a philosophy which denies uniqueness, and promotes the orwellian concept of "oneness". Getting along with the group, sharing, rejecting excellence, all foster sameness. The concepts promoted in the schools tend to encourage acceptance of the idea that a child's mind is no more his own than the toy he is required to share.

This philosophy undergirds the 'planning mentality', which denies the principle of the right to own, use and enjoy, private property. Extended to the mental process, that concept results in the most pernicious exercise of mind control imaginable. It is a form of slavery, which is not only involuntary, but its existence is hidden from the subject person, and the slave doesn't know his master.

The progress of the Planning, Programming and Budgeting System has been marked by milestones of such mind control, and, just recently, another facet of it has surfaced.

Before examining that, it is well to recognize that the bright young people who have participated in the change-agentry for the PPBS were trained somewhere for the job.

Somewhere:

\* the hidden persuaders who moved the prestigious Project Safer California Commission to acceptance of a predetermined plan for all aspects of the legal system, using the sophisticated manipulative technique called "Delphi", were trained for what they did.

Somewhere:

\* the directors of the California Specialized Training Institute, which prepares "peace" officers to assume control of the public they are supposed to serve by preconditioning them through sensitivity training to accept their role as controllers of the citizenry, were trained for what they do.

Somewhere:

\* the perpetrators of the pernicious "Politics of Change" the textbook for neutralizing citizen resistance to imposed schemes, were prepared to develop the techniques of change for use on the mass population.

These, and other such activities, would not be performed by people who valued the integrity of another person's mind. Before such training can be applied, that value must be destroyed. And most of these young people have been through the indoctrination mills known as 'public schools', where alternative values are instilled, allowing later acceptance of such premises as these.

One aspect of the struggle over acceptance of the PPBS which defied explanation relates to the "invisibility" of The System, as a system. That has been remarked on many times. It has been attributed to the deceit and duplicity which were palpably an integral part of The Plan for implementing The System, but that was not a really satisfactory explanation. Another facet of the PPB confrontation was the legislative resistance to acceptance of the true nature of The System, even when the evidence of that nature became overwhelming. Allowance for the natural proclivity of avoiding public admission of error didn't fully explain that.

Now, new light is shed on that bothersome area. A "social science" principle, first propounded 20 years ago by an obscure professor was apparently brought into play.

The Theory of Cognitive Dissonance (TCD, q.v. in your public library), is based on another social theory, that of "congruity". According to TCD, the mind tends involuntarily to block out information not in line (consonant) with previous beliefs and/or experience. Congruity has to do with an experienced, or understood, relevance, which can be either consonant or dissonant.

When things are consonant, a state of mental equilibrium exists, and equilibrium is a subliminal desire of the mind.

If things are dissonant, they are incongruous, and the mind involuntarily attempts to reject the incongruity.

Again, if things are consonant, the mind, also involuntarily, attempts to fortify the congruity, and avoid dissension.

Anyone familiar with these theories will recognize that this is oversimplification, and incomplete as well. Superficial as our research on these theories has been, as applied to what we have learned about the PPBS, consonance and dissonance are more than ivory tower theories - they have been made tools for subversion of the mind. Tests to adapt them to prediction and reaction were conducted as long ago as 1966, and college students were participants - and guinea pigs - in those tests.

Elected officials are prime targets of psychopolitical operatives, for obvious reasons. When citizens attempted to warn of dangers perceived in the so-called Planning, Programming and Budgeting System, legislators displayed an almost total lack of concern. Logical deduction suggests that such indifference HAD to stem from something more than the usual diffidence met when citizens requested action on previous non-representative programs, such as sex-ed, for instance.

Even those legislators who had been receptive to citizen input in the past were unreachable, in the matter of the PPBS.

With TCD in mind, consider: the proponents of the PPBS in California had spent six years gaining mental acceptance by legislators of what was offered as a program for accounting and budgeting. The legislators had accepted the attributes claimed for it by "experts". They considered it a

*Theory of Cognitive Dissonance*  
VI - 11

'space-age' boon; a 'budgeting system'; a new method of accounting. Not just once, but over and over, they had voted approval of it, as its many components were brought to them, for study, for funding, for modification, for extension. Their reputations were now tied to it; their minds understood it as a benefit; their acceptance of it had been continuously re-enforced by "experts".

On top of all that, in California, for example, the elected State Superintendent of Education, who authorized all the documents for the PPBS in education, was identified as a 'conservative', as was the man directly under him, who was a trusted source of information by conservative legislators. Both these men would be sought out by legislators to help untangle the divergent views of PPB proponents, vs citizen opponents. It was later learned that the second man actually headed the PPB project in the Education Department. Thus, the man legislators would normally seek out for help and explanations, was, unknown to them, actually the coordinator of PPB activity in the schools! Would these two trusted officers of the California schools lie to legislators about anything so important?

When citizens asked for recognition by the legislators of a different capability for the PPB than that claimed for it, not only was TCD working against such recognition, but, any advice the legislators sought for verification of the citizens' charges, from sources they believed they could trust, HAD to be negative.

And, all the time, legislators were bombarded with denials of citizens' charges by their paid "experts". Their original beliefs were reenforced; their previous actions supported. Using the fulcrum of TCD on elected representatives, promoters of the PPBS were able to over-ride the citizen rebellion.

Any effort to turn the System around now, MUST take this newly recognized technique into consideration.

Addenda:

The Theory of Cognitive Dissonance - Check articles by name or under "Leon Festinger" (who developed the theory); your public library

"The Politics of Change in Local Government Reform"  
California Commission on Intergovernmental Relations, 1974

THE ULTIMATE WEAPON - 72 - Cybernetics

Like old time vaudeville acts, performing "magic" in full view of the audience, which, diverted by a steady stream of patter, and insignificant but obvious, unrelated movements, encouraged an illusion of reality, the news media manipulates an entire citizenry into accepting the tricks and schemes of the master magicians performing center stage.

If the media were really concerned about the state of the State, its operatives would do some investigative reporting about the reason why so many citizens are continually roused to do what those in charge should do, but are not doing. If "communism" is such a threat that we need "security agencies", why are we having "friendly relations" with the Soviet Union and Red China?

An even more vital question: WHY are Soviet agents going through the most secret secured areas of our military, checking our stockpiles of defense, with no outcry from the media (which is not allowed inside?)

Instead, the pressmen go into a mass frenzy over much less serious matters, diverting public attention from those really needing examination. This is a strategy of deception.

It was Herb Philbrick, of "I Led Three Lives" fame, who first brought into focus the communist use, in the United States, of a spaceage technology as a tool for today's magicians. The communists Philbrick knew called it "cybernetics".

Cybernetics has a legitimate function as a scientific method for improving electronic circuitry - conduits and cables, logic and memory - in computers. Its application as a method for 'government' to use to "improve" the mental processes of the citizenry is quite another matter!

At the time Philbrick served as an undercover agent in the CPUSA (sometime around 1950), he found the local functionaries describing their devious methods of influencing public opinion, as "cybernetics". Pointing out that, to a communist, a human being is simply another "machine" (a resource), Philbrick likened the human nervous system to an electronic circuit. In such a circuit, cybernetics provides a useful method of control - even when the "machine" is human.

Today's dictionaries describe cybernetics as a "science of human control functions", and give its LEGITIMATE use as a secondary function! Approval, by the people planners in our government, of official use of this 'science' on the total "social system" was only a small step away from approval of its use on human subjects.

Philbrick said,

"Cybernetics grew out of the work of Ivan Pavlov, and uses the cause and effect syndromes Pavlov discovered, as well as the feedback mechanism he perfected."

Now, isn't THAT a coincidence? These are basic ingredients of the control system once known as the PPBS!

According to Philbrick, the cells of the Young Communist League were deeply involved in the use of cybernetics as a method for "demolishing the minds and spirits of men", back in midcentury. He described what they were doing as a form of "brainwashing".

More 'coincidence'! That's another facet of the PPBS!

Philbrick stated,

"Cybernetics, according to the communists, is the manipulation and control of information... (also PPB functions-ed.) Now, that has to do with the controlled press in the Iron Curtain countries. It has to do with radio and television and all fields of communications ... you give people only that information you want them to have, and then shield them from all the information you don't want them to hear. And, by this means, by the control of communications, you can control people as you do puppets."

Philbrick made these statements at a Freedom Forum presentation in Los Angeles in 1954. He urged the young people who heard him to adopt cybernetics as a course of special study. And he added:

"It is brand new. I don't know of a single book on the subject, in connection with what the communists are doing with it. The Reds have been working at this subject for many years, and today (1954) they are working around the clock on this study of scientific manipulation and control of information."

Little did he know that those people planners in our government were also (in 1954!) working avidly on this same system in that super-secret unit in DoD, to extend it to every phase of American life!

Only four years after the Philbrick speech, Dr. Lewis A. Aleson, eminent physician, former President of the California Medical Association, and head of L.A. County General Hospital, affirmed that:

"...the art and science of cybernetics, in its perverted form as practiced by the (Soviets), has made considerable inroads on OUR much vaunted freedoms."

It is this "art and science" which is being practiced by the media, as they determine those matters which will keep John Q Public from becoming diverted from the trajectory set to obtain the predetermined goal, and neglect to report those which might alert him to a truly concerning subject. The repeated pounding at the Republican nominee for vice president in 1988 is an oft-used tactic. With Senator McCarthy, the cry was "Give us the names!" With Richard Nixon, it was "Give us the tapes!" With Dan Quayle, it was "Give us the facts!", ignoring the fact that they had the facts. In every case where it is used, this tactic is part of the cybernetic control.

Today, this "science" of cybernetics is nearing completion as a function of our government, promoted by a "leadership" who have known exactly what they were doing. There are hundreds of books on it now, in precisely the "connection with what the communists (were) doing with it" when Philbrick learned about it first hand.

Look in your library under Planning, Programming and Budgeting; Delphi; Zero-based Budgeting; management systems, and follow the references given with these subjects.

The hype of the media speaks eloquently to the activity Philbrick described.

That the essential function of cybernetics, as applied by the Media, has been eminently successful, an "apathetic public", seemingly uncaring about subversion at home, or accommodation with avowed enemies abroad, is witness.

Recommended Reading

"Mental Robots": Lewis A. Aleson, Caxton Printers, 1957

*Cybernetics is the manipulation  
and control of information*



THE ULTIMATE WEAPON - 73 - The Smoking Gun

Lenin is reported to have said that the way to destroy a nation is to debauch its currency. Whether he said that, originated it - or even believed it - is of little moment today. The fact is that the currency of the United States lost its integrity in 1934, and various interventions since then have continued the debauchery. While crippling, the spoliation of the money alone did not destroy America.

It was in 1934, too, that plans to pillage the lawful government of this country - the Constitution - were set into motion. Bastardizing the principles undergirding that government has been a continuing process since. More than half a century later, while damaged, that government is still in place.

1934 also witnessed the announcement by Lavrenti Beria, chief of the Soviet secret police, of a program to debauch the character of the American citizenry as a "necessary preliminary" to the end of nationhood for the United States. The program was called "psychopolitics", and among the "students" gathered at Moscow University to drink from the fountain of wisdom which irrigated the Soviet system, were assorted educators, planners and social workers, who had answered a Call from the United States' National Education Association (NEA) to "see the future work".

These incidents are reported here as a partial answer to the eternal question as to whether or not it is "too late" to put an end to this revolution. So long as there is freedom to share such information as this, the victory over the forces which are manipulating the world remains a possibility.

The "art and science" of psychopolitics was reputed to be able to destroy a nation through corruption of the minds of its people. There is substantive evidence that the standards, morality and integrity of the American character have been so undermined that this nation is now on a rapid course to destruction. At some point in time, that capability can be expected to reach a saturation point, and the will to resist be decimated. Unless or until that time arrives, no effort to put an end to this desecration should be spared.

The continuing reports over the last 10 years of the existence of KGB agents actually working inside Congressional offices will take on a whole new aspect, once the strategies of psychopolitics are understood. The fact that the Soviet equivalent of the CIA has penetrated that area of our government is of critical importance, especially in relation to the elements of psychopolitics which are put forth in the Beria text.

While the visibility of psychopolitics has increased measurably since the 1950s a great many Americans find it difficult to accept its presence in our 'government'. It is of some importance for you to know that even the groups which first brought this information to public attention were concerned about how people would react to such knowledge. The American Public Relations Forum, a responsible association of concerned citizens, prefaced the pamphlet about psychopolitics which they distributed back in the 50s with this statement:

"This booklet will sound so fantastic that you are likely to put it down in disgust, exclaiming 'This could never happen in America.'"

It doesn't sound that fantastic today, but it is still incredible. In the text, Beria is credited with this description of psychopolitics:

"Psychopolitics is the art and science of asserting and maintaining dominion over the thoughts and loyalties of individuals, officers, bureaus and masses, and the effecting of conquest of enemy nations through 'mental healing'".

The strategies of psychopolitics stem directly from the experiments of Ivan Pavlov. The path from Pavlov's laboratory to the classroom at Moscow University is obscure, but the record of social science advances is replete with reference material demonstrating the connection.\* Reason suggests that the art of psychopolitics was developed to place the existing tool of 'conditioned response' in the hands of social scientists, who could adapt the "virus and the germ" of pavlovian control of mental processes to systematic application, creating through directed reaction of the citizenry, "a sickness in the body (politic), which then spreads to the whole (nation)".

Information about psychopolitics was brought out in the 50s as a result of the extreme pressures to reform the methods and concepts previously involved in treatment and handling of the "mentally ill". One of North Dakota's greatest sons, the late Representative Usher Burdick, placed portions of the Beria textbook on psychopolitics in the Congressional Record, condemning the process as "destruction of the mind". In his opening remarks he said:

"Mr Speaker, one way to destroy any people is to destroy their health. The destruction of the mind is less obvious, and not an open act of murder, but the millions who have had their minds destroyed by this fascistic and communistic scheme of controlling the people, are as dead as they will ever be..."

Actually, destruction of the mind is worse than murder, for it MUST include destruction of the soul and spirit as well.

The psychopolitics textbook not only gives the techniques for 'menticide' (murder of the mind, according to von Meerlo), but it also exposes the meaning of the pressures regarding the "mental health" situation, which was taking place here in the 50s. But the book did more than that. It put in focus the totality of the plot to rule the world through control of the minds of the world's peoples.

The least informed amongst us can now recognize that great inroads have been made into the thinking of Americans. Witness the so-called "apathy", which permits acceptance of perversions which were unthinkable when psychopolitics first became operative forty years ago. Witness the accelerating decline of both public and private morality, as evidenced in attitudes toward killing of the unborn; scandalous behavior in every level of society, which receives little concern; toleration of sexual aberrations which range the gamut of debauchery and are portrayed graphically in print, on TV and the silver screen, with minimal opposition.

The very existence of the comparative few who react with concern to such matters emphasizes the enormity of the successful use of psychopolitics on the majority of citizens. Even those who decry these

outrageous blotches on the mores of America, are incapacitated to one degree or another in dealing with them, because of their own subjection to the strategies inherent in psychopolitics, which immobilize opposition, and create division and chaos.

In the 50s, "liberals" attacked the Beria text as a forgery (ignoring the fact that a forgery, ipso facto, presumes an original). "Conservatives" hesitated at chancing lack of credibility by distributing it.

Today, life in America is so altered that, rather than seeming 'far out', the content of this text has the appearance of being a blueprint for the processes by which that alteration has been accomplished. It's source is no longer of any consequence. Its validity lies in the evidence of the activation of its strategies, and the imminent realization of its objectives.

Those objectives include creation of a "slave mentality" in the public mind and transfer of then-existing loyalties of the people from the previous methods of governing to the communal "goals of the State" - goals predetermined, and secured by use of the same "art and science" which suborned acceptance.

Activation by agents within the 'government' of this systematic subversion of the mind in the form of a management and control system, is a smoking gun, more deadly in its capability than any nuclear weapon.

The goals of the State, as envisaged in the Beria document, are meticulously described in George Orwell's "1984". Of far more importance than that, they have been put forth in the Eisenhower "Goals for Americans" program.

Consider, if you will, the presence of KGB agents in representative offices in our nation as you read the following statement, represented as part of the opening remarks of Beria to the "students" who flocked from America to the Moscow Summer School in 1934:

"Given a short time with a psychopolitician, you can alter forever the loyalty of... a leader in his own country... and when you have succeeded, you will discover that you can now effect your own legislation at will, and you can... by a pretense as to your effectiveness, make your capitalist, himself, by his own appropriations, finance a large portion of the quiet conquest of a nation..."

Addenda:

"Science" Magazine article, "Conditions Favoring Major Advances in Science", (60 such "advances" listed - 22 directly involving The System) 1971, Vol.171

Pamphlet, "BRAINWASHING - A Synthesis of the Russian Textbook on Psychopolitics" compiled by Charles Stickley, PhD. 1952.

THE ULTIMATE WEAPON - 74 - Removing the Lid on Spending

On 4 March 1958, a Congressman rose on the floor of the House, to express his opposition to HR 8002, "the so-called accrued expenditure bill".

In part, he said,

"The paramount question is, will it do what it says it will do? ... It will not do any of these things... HR 8002 would delude the people for one...(or) two years, into thinking that a lot of money was being saved... It would look attractive and painless, but the day of rude awakening would, of course, come...

"WILL HR 8002 BRING ABOUT ECONOMY IN GOVERNMENT EXPENDITURES? Some of its proponents have said it would, but it will not. The people have been told it will. (But) the Hoover Commission never said it would save a specific sum. The task force expressed a "belief" that about \$4 billion annually could be saved... No proof. No evidence. Just picked (a figure) out of the air... just a feeling of satisfaction that it would save several millions..."

This bill, as now written, will cost MORE money, not save money..."

That Congressman was Gerald R. Ford (R.Mich). He was addressing the bill which was proposed as a result of a recommendation by the Hoover Commission on Reroganzation of the Executive Department. That recommendation was for a new kind of budgeting and accounting to be imposed on all executive offices. That phrase, "budgeting and accounting" has long been a codephrase for the Planning, Programming and Budgeting System, and HR 8002 was the initiation of governmental application of The System.

In his argument, the Congressman pointed out that the Budget Director had admitted that the stated \$4 billion 'saving' was "intangible" - and that HE didn't really think HR 8002 would bring such savings. He, too, had a "feeling" that it might save two or three millions - NOT billions.

History has recorded that the so-called "accrual" bill did not, in fact, result in "saving" money - that it has, rather, removed the lid on spending, has COST the taxpayers billions on uncounted billions of dollars, and encroached on their priceless heritage of individual liberty, as well.

The costs were already astronomical, and those liberties already diminished, when that Congressman took the oath of office for the Presidency of the United States of America.

Since Gerald R. Ford was part of the unorganized opposition to the bill which opened the government door to the "spaceage" budgeting and accounting system, which was, even then, accurately described as "revolutionary", it might be thought that one of the first acts of Gerald Ford as the occupant of the White House would be to commence reversing the damage that System had already done to this government, and to restrain its encroachment on the lives and fortunes of its citizens. This he did not do.

It might have been different, had the debates on HR 8002 revealed the true purpose of this "new" accounting system, but that purpose was

carefully concealed then, as it is now. At that time, just exposing the fact that the claims made for it were false, took some doing. That this method of "accounting" was a sham was evident, even then.

By the time Gerald Ford took over the duties of Richard Nixon, however, the warnings he and his colleagues in the 85th Congress had issued had been revealed to be accurate. By that time, the revolutionary System was well advanced to full implementation, despite a clear and constant record of failure to perform as claimed.

There was ample evidence to impel the man in the highest office of this country to repudiate a program which he had known from the beginning to be, as he, himself, stated, "completely phony".

But Gerald Ford did not do that.

Only he can tell why, as the Occupant of the Oval Office, he did not divulge why he has not revealed what he knew to be fact to the people of this country, who have a right to know. He is not likely ever to do that, for the record indicates deep involvement of the multi-national corporations in the development and use of The System, from the time they brought it to this country from the Soviet Union in 1921, to install in their various enterprises. Gerald Ford is not the man to blow the whistle on the Establishment. The startling choice of Ford as second in command of this country might well be tied to his work as a Congressman.

According to chroniclers Barnet and Muller\*, "a principal use of central planning in the global enterprise is tax minimization". Their description of the machinations involved in systematic avoidance of paying taxes by corporate interests are too convoluted to recite here. Barnet/Muller, in describing the corporate strategies, point out that "skilled obfuscation is now an essential accounting tool." "Skilled obfuscation" is what The System does best. Barnet/Muller say:

"Corporations give their stockholders one picture of how well they are doing, and the Internal Revenue Service another."

Government accountants give the legislators and the public one picture of what is being done with the public monies, but its actual use is hidden in the programmed budget.

Barnet/Muller quote a financial expert as stating that 'generally accepted accounting principles' as used in corporate financial statements, are a fiction. Such principles are also a fiction when it comes to government budgets. They also quote an accounting expert as saying that

"Accounting today permits a shaping of results to attain a desired end".

No one who understands The System would try to refute that.

Accrual accounting is of the essence in the program designed to replace "horse and buggy" government with "spaceage" technology. "Horse and buggy" economics demanded the old-fashioned ethic of not spending when you can't pay. Spaceage economics are based on the theory that if you do not have money, you use credit.

Accrual accounting legalizes the machinery by which government can eat its cake, and have it, too.

When the proponents of HR 8002 boasted of the "savings" accrual accounting would realize, they lied - and they knew they lied.

What actually results from a change to accrual accounting, is a onetime 'surplus', as the changeover is made from cost accounting to the accrual

system. That changeover allows the on-hand balance to be integrated into future appropriations, showing what is really a duplicate entry. It appears that the hope was that the apparent "surplus" would override the bite which comes in the second or third year of accrual accounting - or that the short memory of the public would not connect cause and effect.

After that first windfall, the inevitable 'shortfall' would be hidden by "longrange financing" for multiyear programs. Of greatest importance, The System is manipulative, and the budgeting and accounting functions are used to lock in programs designed to realize the new Goals for America.

The results of HR 8002 are now evident in the trillion dollar budget; the multi-billion dollar debt to the Federal Reserve; the untouchable expenses locked into ongoing long-range programs; and those ongoing programs, themselves. All these are a foretaste of the managed and controlled world being created today, by the multinationals, the Planners, their collaborators and cooperators.

(Lest any think KMH has suddenly become a genius in the world of mathematics, please be advised that is not so. It was essential, in exposing the System, to be able to describe the way it impacts budgeting and accounting, so folks like you who understand these things, could see how fake the claims were. So I went to the library, and, with assistance, found books on accrual, from which the above explanation was extrapolated. (Fortunately, I didn't have to know what these strings of words mean - I was already convinced, when I learned the place accrual has in the System, that the System was a phony, and so was the use of 'accrual accounting'. But you, who do understand these things, had to know the way it really operates, if you were to be convinced of the scam, so I had to do this homework.)

Recommended reading:

\*"GLOBAL REACH - The Power of the Multinational Corporations"  
Richard J. Barnet & Ronald E. Muller - Simon and Schuster 1974.

THE ULTIMATE WEAPON - 75 - Buggy Whips  
and Space Technology

It was in 1958 that Congress approved, with no debate, the "space-age" system of accounting to replace "horse-and-buggy" methods which, by trial and error through the years, had proven effective.

It was 1969, when California citizens learned that this "revolutionary" system was being installed, without fanfare or debate, at all levels of their State government and in their schools - as well as in those of other states across the length and breadth of America.

After all these years, there are some areas of the country still unaware that they have been put under The System. In 1990, there are still a few small pockets of government which have just begun to enter The System, such as the San Juan Islands, which constitute a County in the State of Washington.

Situations which, in less pragmatic times, would have demanded an accounting, are ignored today. The touted "accountability" of the Planning, Programming and Budgeting System is neither requested nor required. Because of the demonstrable inability of The System to fulfill its stated purposes, those areas where the final links are being installed are kept very low key. Hallmarks of installation are: pressures to build a new county courthouse; public acknowledgement that a breakdown has occurred in controlling public funds; the need for new computers to provide 'accountability'.

In the island county of San Juan, located in Puget Sound in the State of Washington, preparations for The System began several years ago, centered on the need for a new Courthouse. "Courthouse renewal" is a key to systematic entry. In California, in the mid60s, there was a sudden rash of "outdated", "inadequate facilities" all over the State, which had to be replaced, just before installation of The System began. This was to make room for the huge computers and the systems analysts to man them - but that fact was not brought out by the promoters of the new County Centers.

The actual beginning of The System in the San Juans was indicated in 1987, on page 11 of the local weekly, under the headline, "System keeps track of pennies but not thousands". This did not refer to The System, but to present practice. The article told of employees filling out purchase orders for .59 cent items, failing to report costs of some, and of spending \$5,300 on one item before filling out any purchase orders. It was also reported that there was no record of what supplies were on hand. These, and similar, practices were cited as proving a need for "a systematic approach to controlling expense". By what logic could the people be convinced that such flagrant ineptitude (or deliberate chaos?) could be magically transformed by a different method of budgeting?

It is generally agreed that, in passing Proposition 13 (which sparked a national movement), Californians were demanding a cutback in government, and "accountability" for spending. After creating chaos and confusion over having to live with the restrictions of 13, the State suddenly "found" six billion dollars, with which the will of the people was effectively thwarted. Not one legislator demanded an accounting of the six billion dollars, NOR an explanation of why the costly, controversial PPBS didn't perform its stated function.

In San Francisco, the Bay Area Rapid Transit (BART - designed,

constructed and operated under PPB) consistently failed to provide its promised merits; cost far more than The System projected; and suffered serious "accidents" which were not foreseen nor prevented, but should have been. No official recognized BART as one more failure of the PPBS.

In Washington D. C., Secretary Califano of HEW (which was placed under The System by Lyndon Johnson) was forced to admit that his Department 'lost' \$17 million dollars, which was more than that complex cost when it was created a few short years before. Admitted or not, losses by other departments and agencies are far greater than all the claimed "savings" made by succeeding administrations combined.

In 1989, the Bellingham, Washington, local paper heralded in banner headlines the failure of the State "Community Services Management and Operations System"(COSMOS) to perform the services for which it was installed. Headlined "Flawed Computer Baffles State", the article detailed a carbon copy in COSMOS of the failures of PPB over the 20-year period during which billions of dollars have been poured into the Systematic rathole.

The paper reported that COSMOS was scheduled to cost \$10,000,000 before the pilot program began, and that that projected cost shot up to 40 millions before it was finished. Citing a number of State officials, the article reported:

"After years of public reports and internal memoranda warning (that) the...System was being designed poorly, and had serious flaws, a three-month pilot test proved the fears were justified."

The paper reported a 1986 internal memo which listed "hundreds of problems" with the system, leading to a \$12,000 "analysis" of COSMOS, which identified scores of those problems (but not the real one). Another internal memo called for an end to "futile attempts to conceal the systems flaws, and (to) start finding real, legitimate solutions."

What's going on here? WHO's in charge?

Under the Constitutional system of checks and balances, heads would be rolling over such gross mismanagement. Under this space-age technique, no one seems to know the questions, let alone the answers. Nor is there any legislator with the intestinal fortitude to stand up and protest, let alone demand the promised "accountability".

WHY NOT? This is the question which haunts PPB implementation, everywhere.

When citizens forced legislative oversight of the activities surrounding the entry of PPBS into California, reaction of the elected representatives was unbelievable. Individually, they claimed ignorance of The System, yet, almost to a man, were resistant to accepting the facts citizens presented to them. Only ONE legislator instituted independent research, with results which more than justified the citizen concerns. He put out a White Paper, which gave the lie to every claim made for The System.

Unable to resist the clamor for legislative examination of The System, the State Legislative Joint Committee on Education finally scheduled time to "hear the charges".

Citizens came to the Hearing from all over the State, briefcases bulging with source material, anxious to be heard.



Instead of letting them present their information, and then obtaining rebuttal from officials defending The System, the Committee spent ten hours listening to the same tired hogwash which had obtained acceptance of The System, from the same tired advocates who had promoted it in the first place.

The citizens stirred restlessly through a long day, as an endless line of paid hacks touted the "merits" of The System, while those who paid the bills for that farce were not even allowed to challenge outrageous, demonstrable lies being repeated again and again, by 'expert' after 'expert' while the dreary hours ticked away.

As the day droned into night, many of the citizens had to leave, to catch the last planes or busses home. By eleven p.m. only a handful of the Committee remained to "hear" the 'other side'. By then, it was clear to the remaining citizens that the "hearing" wasn't that at all. It was a sop, designed to quiet the opposition. "You asked for a hearing. You got it."

Of the handful of opponents who remained, most declined to lend dignity to such a travesty on the right to petition. One legislator appeared to have gone to sleep. Only a very few of the citizens still there could force themselves to present their prepared arguments to legislators who clearly were not interested in anything they might say.

The question "WHY NOT?" still hangs in the air. WHY were those legislators NOT willing to examine any program so clearly controversial?

While it is only too true that every legislator in office at the time the PPBS was legally permitted, had some degree of culpability in allowing it, at that time citizens were only too willing to recognize that their representatives had been bilked by a confidence swindle on a scale never before attempted. (The evidence of swindle is overwhelming.) By refusing to receive the evidence of that swindle, those legislators not only lost their integrity, but their inaction permitted extension of The System. It is now operative throughout the nation, at every level of government, and almost universally.

Each passing day brings some additional evidence of increased power of the federal government, at the expense of the 9th and 10th amendments, directly attributable to the Planning, Programming and Budgeting System. Every day, State and local governments are placing new controls over their citizens - controls only possible because of the capabilities of The System.

THESE are the important issues of today, but they will not be acknowledged in any political debates. Watergate, Iran/Contra, House Speaker Jim Wright's peccadillos, the rising clamor for Constitutional Amendments, the proposed Constitutional Convention (ConCon), or any of the matters reported by the media, all pale in significance, when the impact of this System is placed in the scale.

NONE of the current corrective suggestions which are being put forward to restore this nation addresses this problem, which pervades every recognized ill facing the nation today. NONE of those "problems" will be solved, unless and until systematic management is recognized as an inherent element of all of them, and is taken into consideration in any attempt to put an end to the subversion which is making a shambles of all that was fine and good in "horse and buggy" America.

Addenda:

"White Paper" - Robert Burke (R.Assemblyman, Orange County)

\*\*Chaired by John Vasconcellos (D-Assemblyman, Santa Clara County)

## THE ULTIMATE WEAPON - 76 - The Last Hurrah?

Over the years, as application of systems technology increased, it became evident to those of us who were monitoring it that its penetration of all areas of American life had become as alarming as the fact of its existence.

Even more alarming was the fact that its use as a management tool was not being recognized by our representatives. While that is understandable since so few of them even knew of its existence, nonetheless it was of strategic importance. Of those who knew about The System, only a fraction really understood its capabilities. Our constant effort has been to obtain recognition of it, its sources, implementation in our government, and present and potential usage.

Several times since we first learned of its existence it has been necessary for us to report that one or another of The System's potentials had been moved into the "present use" file. Equally alarming has been the fact that the extrapolations we made from the working papers about its potential have proved to be accurate. This was one instance when it would have been a blessing to be wrong!

Until the documents involved in reapportionment fell into our hands, there wasn't sufficient evidence to confirm that systematic subversion of the elective process was operative. The System's very existence was kept so low-key that maintaining a credibility level for information about it had been a major concern.

It wasn't until 1976 that we learned that its capability for directing the outcome of individual elections was operational. For it was during the bicentennial anniversary of the Declaration of Independence that we learned that systematic control was sounding the death knell for the freedom of choice so eloquently expressed in that priceless document.

In 1976, The System put Jimmy Who in the White House.

No headlines broke the biggest story of the year. It may well have been the biggest story of this century. To learn that fact, one had to know and recognize the buzzwords which identify The System for the illuminated initiates.

Some of our readers may also be fans of veteran columnist/reporter Hillaire duBerrier. Those who are, have probably read his article "The Carter Coup". If so, did they recognize the technique duBerrier described as having been used to obtain the election of the peanut king as being, in fact, confirmation of systematic control of that election?

For the record, we will examine that HduB article, and highlight the facts which prove the use of systems strategies in that campaign.

duBerrier quotes from a London "Observer" article:

"Four years ago, this determined man, supported only by a small group of assistants, ...decided he wanted the Democratic Presidential nomination, and he began to secretly lay his plans accordingly..."

(There could be some quarrel about WHO decided this, and whether that small group" were really "assistants" or something more. Be that as it may, let duB continue his Report:)

" ...it was Milton Katz who took up Carter's cause four years ago... Katz, who has served the Ford Foundation, the Carnegie Endowment for International Peace, the World Affairs Council, and is a member of the Council on Foreign Relations, ...Averill Harriman, Zbigniew Brzezinski (and) Nelson Rockefeller... were members of Jimmy Carter's secret planning team..."

HduB then returns to the Observer story:

"...by (the time of) the New Hampshire primary, much of the work had been done. The mood of the American people had been analyzed, and it had been established how Carter might turn that mood into votes. Unknown to most of America, the Carter Coup was already half made." (emp.added, ed.)

duBerrier continues:

"What we are being told in a sneering fashion, is that for the past four years, a group of intellectuals and master conspirators from the Rockefeller machine has been studying American reaction, analyzing moods, and deciding what THEIR choice of the perfect stooge should SAY and DO in 1976 to pull off a successful con." (emp.add.)

What HduB and the Observer are describing is a perfect example of The System at work stealing an election - taking the decision-making process out of the hands of the citizens. Many of these phrases are right out of the systems textbooks. This is precisely what we have tried to warn could happen, and it is precisely the way a successful systems operation would be managed.

Don't hold Jimmy and his team alone responsible, though, for the two candidates who faced each other at the Republican Convention had the same capability, and probably used it.

Ford, in the Executive Office, had access to the most complete, state of the art information system in this country in his Office of Management and Budget. There, too, what are probably the most efficient computers and technicians in America are gathered under one roof. (There is one in Europe of much greater capacity, with probably the world's most erudite systems managers, which handles the entire world. They call it "The Beast".)

Ronald Reagan, on the other hand, as Governor of California, was the official responsible for the installation of the pilot governmental PPBS system, which served as a prototype for all the other States. If he didn't have a scenario of his prospects for election, and his intended campaign, run before he left office, he would not have been smart enough to play in this league. The experience of eight years of his incumbency of the White House has proved he was, indeed, league material.

There is a lesson in this for all Americans. The System can be used to control ANY election. It was, in all likelihood, used in key campaigns at several political levels in 1976. There is reason to believe that it has been used in some congressional campaigns.

When citizens of California, failing to stop the implementation of the PPBS in their State, appealed to Congress for help, the Congress, instead, installed the PPBS in the Congressional Budget Office, for their own use.

The argument for installing it there centered on the need to meet the challenge of the OMB System, in order to neutralize Executive attempts to frustrate Congress.

It may well be that those Members who might be in difficulty in their own districts, have already programmed their elections. There has always been an edge in favor of the incumbent, but the PPBS can provide assurance of an election. Especially since only the incumbent would usually be expected to have access to a program system.

This is but one reason why Americans should make every effort to elect only honorable, responsible representatives to Congress, but it is a powerful one. There will come a day, unless they do, when that will no longer be an option.

## THE ULTIMATE WEAPON - 78 - Mental Trojan Horse

There are two avenues for bringing an individual or a group under systematic control. They may be used separately, or as adjuncts in a single assault. One way is to apply external pressures, to affect the subject's actions. The second is to apply conditioning strategies to affect the subject's mind.

The first method is recognizable, because, being external, it is visible and tangible. It plays on a person's sensibilities, causing him to modify his behavior voluntarily, because of fear, shame, ridicule, or any of a number of other reasons.

Being rejected by associates because ones' beliefs mark one as 'outside the pale' is a particularly effective external conditioning strategy. Although it had been used before then, this method became official policy of the "men and forces" within our government in the early 60s, with the issuance of the Reuther and Fulbright Memoranda. When those documents identified the dangers to administrative plans existing in "education and propaganda" activities by citizens and the military - activities which ran counter to those plans - a campaign was initiated to isolate those carriers of the germ of patriotism. And it worked.

The second method of control alters concepts, loyalties and values, and causes involuntary behavior modification, because of the altered beliefs.

The record of direct, external, assault on those who persist in exposing the abuses being perpetrated from within the government, has been comparatively muted recently. A logical explanation might be that other means have been perfected to constrain the opposition.

That there has been a high level of penetration of the ranks of patriots has been documented by a number of researchers. It is visible in the phenomenon of 'apathy', as well as in misplaced or nonproductive effort. The "respectable" 'New Right' is maneuvered into positions of leadership, from which subtle encouragement to target 'noncontroversial' matters bleeds off segments of the resistance from productive effort, or, just as subtly, leads activists to attempt to "work within the system". "Working within the system" allows direct control of the person who attempts it, through Delphi, group dynamics, or similar strategies. Such penetration comes under the heading "external pressure". Control is exerted through misdirection of energy toward non-productive targets.

The major reason for the lessening of vicious personal attacks, though, is more likely the successful insertion into government of the management and control system once known as PPBS. It is ever more obvious that the capabilities of The System have been activated, and are being directed at both specific and mass targets.

On 4 September, 1990, Channel 5 NBC's "Today Show" was made the conduit for announcement of the penetration of this Trojan Horse System into the most vulnerable - and critical - area of this battle for the mind of America: direct application on its future citizens.

Calling The System "Zero-Based Management" (ZBM), the anchor person interviewed school activists now working with The System as it is incorporated into the curricula in New York, Brooklyn and Louisville, Kentucky. Louisville's change agent was a black woman who said the "children will be taught" (sic) by this new method.

The impetus for this exposure was the announcement that 80 schools in New York were initiating this efficient "teaching method". Clips were shown of of PS 41 in Brooklyn, where ZBM has been operative for 4 years. The clips showed enthusiastic 8 / 9 year old Brooklyn students in a classroom packed with computers.

It will be interesting to follow this expected development, and determine whether these are the pilots for general penetration nationwide, or whether they are incidents in total implementation. If they are pilots, they demonstrate our thesis that first testing of innovative programs is done in areas where least resistance can be expected. New York City and Brooklyn are ideal for this purpose, if only because of their size and lack of community adhesion. As for Louisville, it is not difficult to envision the avidity with which school personnel would snap at the bait of the unlimited "free" money which would pour into their district to pay for participation.

It is not too difficult to develop scenarios for managing "family life" with ZBM 'efficiency'. The ultimate tool of systematic control is debauching of the citizenry of a target country. Debauchery is clearly rampant in our society today, the "sex education" in the schools has made no small contribution in this area. The destruction of the moral fiber of Americans is nowhere being applied more obviously than through the "boobtube" and radio, unless it is in the various programs which directly affect school children. With the added capability of systematic application, expect - and look for - even more devastating effects.

The constant stress in media areas on sexual matters goes far beyond the X- and R-rated movies; even beyond the saturation reporting sexually-related incidents in the 'news'. This latter has become little more than a recital of a dictionary of filth. Even 'family' shows are including education in gutter sex, disguised as entertainment. Many of the advertisements are either pornographic, or deal with matters which once were only discussed with a physician. Camera angles are chosen which forcefully direct attention to areas of the body which direct the mind toward prurience.

Parallel to the debauching of personal principles and ethics, is the debauching of the government, itself. Not just in the assaults on institutions, procedures and methods, which are objects of extreme - and justified - concern, but in the destruction of the people's confidence in those who hold public office. Watergate, ABSCAM, and the 'page' scandals, each exert pressure toward reducing a belief in a capability for reform.

Nixon was returned to the White House for his second term, on a landslide of public approval, only to be forced to leave in disgrace, a few short months later. In the process, the Office he held was diminished.

The victims of ABSCAM were all respected in their own districts, with good and sufficient reason. When that respect was destroyed, the offices they had held were also diminished.

That mass assault had a rehearsal in the attack on Cornelius Gallagher, whose investigation into "behavior modification" had begun to expose the edges of the darkest secrets of the insurgents within the government.

Larry MacDonald had not succumbed to the pressure applied to him, nor allowed himself to be inveigled into a compromised position, and there are few hardcore patriots who do not believe that his life (and, incidentally, all those other victims of the Soviet shootdown) was forfeit, as a result. What message does that send to those others who might feel that they could serve America by accepting public office?

How many of those same patriots, though, who mourn for Larry MacDonald who did not break, are willing to believe that John Schmitz, for instance, was just as surely a victim, even though he succumbed?

How can Americans be brought to understand that the assault on the mind is just as deadly as an air-to-air missile, and the more lethal, because

the strategies by which one's loyalties, concepts and values are altered, cannot easily be identified? Who mourns for the young victims of the strategies of conditioning - America's sons and daughters, lost in the fog of drug-induced prurience, ending in the horrendous stats on teen-age "suicide" - or, perhaps even worse, a long lifetime, suffering the results of youthful error? Who is willing to look for the real cause of this molochian tragedy?

Who will mount vigilance against this mental Trojan Horse?

On Sunday, 29 January, 1984, Parade Magazine devoted its pages to "The Best and Worst of 1983". Now hear the "Best TV News" from that issue:

"Without fanfare, Stimutech, a small Michigan company, introduced a new product this week, that uses subliminal perception to help people accomplish any of eight goals: losing weight; stop smoking or drinking; improve sex life, athletic skills, or study habits; or boost career success. All while watching television."

Any who believe that those goals are the limit of this capability, or that subliminal persuasion is new, simply have not done their homework. The fact is that external control of the mind is now a very real fact of life, and it had better be recognized as such, before there are none left outside its perimeter to blow the whistle on this orwellian nightmare.

Recommended Reading:

"Subliminal Seduction" Wilson Bryan Key Signet Books 1972

"ClamPlate Orgy Signet 1981

During the 1950s, bellringers for "Mental Health" doggedly trudged from door to door, begging donations for 'local' mental health programs. Legislators worked long hours on bill after bill trying to 'improve' "mental health" services; State after State jumped on the bandwagon, and uncountable organizations had 'mental health' as a priority on their agenda.

Innocently or not, ALL supporters of 'mental health' parroted Establishment dicta on the need to 'improve' mental health. Whether they were eminent physicians, psychiatrists or psychologists; nurses, teachers or commercial entrepreneurs; PTA leaders, Red Cross volunteers housewives or bankers; scholars, professors or legislators, all followed the Stalin Standard.

The Mental Health movement, as a movement, was kicked off at the NEA-approved and promoted, Soviet-controlled "Summer Schools" in Moscow in the early 30s - "Schools" attended by hundreds of teachers, social workers and 'mental health' practitioners from the United States. The keynote address at the first session was given by then-head of the Soviet KGB, Lavrenti Beria.

Beria spoke on "psychopolitics". He told the assemblage that it was intended to deal with "... highly educated personnel, the very top strata" of society. He asserted that, by the use of psychopolitics, established methods for care of the 'mentally ill' would be eliminated. Thus, he said, the way would be cleared for the ultimate use of cybernetics. That ultimate use could render sane people incompetent; personal loyalties could be altered; political leaders could be made mental cripples; mass "neo-hypnotism" could make an entire nation non-resistant, and even children could be "channeled" into criminality. All of these capabilities fall into the category of "behavior modification".

According to Beria, the end result of such manipulation would be non-armed conquest of a nation.

Although teachers even then were "poormouthing" about their low pay, and it was mid-depression, somehow they found the ability to pay for this trip. It makes one wonder.

Somewhere near the top of the list of horrors which came out of that conclave has to be the fact that there is no record that any of those people walked out on the lectures, nor ever attempted to warn either United States officials of what went on, or tell the people what was said and done there. Educational and Establishment documents since then have dealt extensively with the subject matter of the Summer School lectures, but always in a positive vein. Reams of official reports have recommended "behavior modification" (BM) as a treatment for "curing" every kind of human problem, and BM has become a widely accepted intervention for all kinds of 'problems', especially in the schools, where experimentation on those least able to resist has almost totally displaced the original purpose of education.

Behavior modification is the treatment of choice on "delinquent youth", when their rebellion brings a confrontation with the law.

Even when BM is being used for a stated, legitimate, purpose, it is possible to modify other, undisclosed, facets of behavior in the process. There is a suspicion that the assault on smoking has an ulterior purpose, for BM is the most effective method of ridding smokers of their filthy



habit. The statement by the erstwhile Surgeon General of the United States that the Goal was not to have an entire smoke-free nation, but to have a universally negative attitude on smoking lends credence to such a suspicion.

BM is an extension of the experiments with "conditioned reflexes" on dogs conducted by Soviet 'scientist' Ivan Pavlov. Until Pavlov's own reports of those experiments are read, one is not likely to understand the full scope of what they comprised.

Pavlov (his supporters declare) was a "great scientist", dedicated, kindly, benevolent, a great Russian patriot. He had (they say) no interest in politics, and most especially no interest in the Soviet takeover of his motherland. Being a patriot (they say) he just stayed in Russia and worked under the enslavers of his countrymen, accepting without question the increasingly magnificent facilities they gave him.

Pavlov's own records put the lie to most of these artful fantasies. He was dedicated, that is sure certain, and enjoyed what he was doing. But was it "scientific"? Kindly? Benevolent? What he "was doing" was devising ways of controlling the mind by outside intervention - and his methods were not gentle. One has to wonder if these sycophants who praise him so highly would be so sanguine if the techniques of Comrade Ivan Petrovich were to be used on them!

The conditioning experiments related to causing dogs to salivate by using lights and bells to signal food offerings are probably the ones best known. What is reported of these is the least revolting side of the work he did.

He explains in one of his lectures that originally he had considered using monkeys in his experiments, because they were "at the top of the zoological ladder", but he chose dogs "because they were man's best friend" - even to the point of helping him to "emerge from savagery". The methods Pavlov used on man's best friend tend to make one believe that some men did not emerge very far. Some of his techniques are horrifying, and the end he sought makes a mockery of civilization.

His techniques included the use of stimulation through electric shock, applying acid to, and scraping pieces of skin from his trembling "friends". Application of extreme heat and cold; noxious fumes; removal of parts of the brain. All these and more were coupled with "reward and punishment" to validate his theories. Of course, no one claims that man is the dog's best friend.

In 1918, after the Soviet revolution, Pavlov "had the opportunity" to include "a number of cases of insanity" (humans) in his experiments. From the record, it does not appear that this was for the purpose of helping those poor souls, but was simply an extension of his work on dogs.

Study of his lectures leaves no doubt that his real intent was the use of mind conditioning through reflex action to bring about predetermined changes in the thought process of normal human beings - not to correct existing aberrations.

Pavlov made no secret of the fact that he was a disciple of Darwin, and considered (as communists do) that man is simply a higher form of animal life - with no divine spark to separate him from the beasts. It is not surprising then that he made no distinction between practicing his "art" on the one or the other.

One of his more abhorrent experiments he called "The Reflex of Freedom". He tells of a shepherd dog with "especial characteristics". He tried all the usual stimuli, but none of them worked. Then he noted that

this dog was most cooperative without restraints. Pavlov wrote:

"... the dog did not tolerate being tied, nor having the freedom of his movements limited. Before us there was the sharply emphasized... REFLEX OF FREEDOM."

So they really went to work on this one. Twenty hours of starvation before he was brought to the table was not enough to suppress this reflex of freedom. Electrical destruction of tender skin. Still he would not eat.

"Is the food reflex weaker than the reflex of pain?"

asked the 'scientist'.

The stimulation was increased, time between food offerings made longer. Still this dog did not respond. Stimulation was stopped, and food offered again. Finally he began to eat. Back to the stimuli again. It took three months before the "reflex of freedom" gradually disappeared.

Continuing the experiment, Pavlov decided to restore the dog's reflex of freedom, by reversing the procedures. It took only one and a half months for the dog to regain his strong rebellion against restraint, compared to three months to destroy it. Pavlov then again reversed the course of treatment. This time it took only another month and a half to finally suppress the memory of freedom forever. "Then", wrote Pavlov, "it was as easy to work with this dog as with the others." And the Goal was achieved.

Pavlov set that Goal. The dog was put through the program, evaluated, found wanting, and recycled through the program again, with added adjustments to correct previous failure. Evaluated again, the dog had reached the Goal. A new goal - to make acceptance permanent, was set. The cycle was repeated in reverse, the animal was taken back to the point of beginning, then the cycle was reversed again. The final evaluation: "GOAL ACHIEVED." And this shepherd gave no more trouble.

This is The System now being used to control the "undermining process" of progressive education in the United States, and to destroy the "reflex of freedom" in the citizenry which is so troublesome in a managed and controlled society.

This is The System universally adopted in the public schools in the United States.

This is The System which has been installed in every branch of our government.

Is there anyone who can justify the use of such a System under such a Constitution as is the lawful government of this country?

Recommended Reading:

"Lectures on Conditioned Reflex" Ivan Petrovich Pavlov,  
Trans.Ed. - W. Horsley Gantt, Vol.I, International Publishers,  
1928

THE ULTIMATE WEAPON - 79 - The 5-5-5 Project

Until 1966, government implementation of the Planning, Programming and Budgeting System had been limited to its installation in the Department of Defense (DoD). There, no elected official except the Resident of the White House had to give consent - or even be consulted - and no one answerable to the citizens could interfere. Let the Generals grumble, and the chips fall where they might, promoters of The System had a free hand in DoD.

In the late 50s, 'thinktanks' around the country began perfecting the capabilities of The System which had been incubated in a supersecret section of the Pentagon ever since the DoD was created in 1947. Experimental projects had been developed to test the efficiency of The System.

There must have been an urgency to get The System in place, because in 1966, before the returns were in on the exercise of systems management in Vietnam, Lyndon Johnson ordered the entire Executive Department to install The System. Again, no other elected official had to be consulted.

Even before doing, that, though, in 1965, Johnson began to apply his many talents as a persuader to obtain grants from Congress for implementation of The System in other host governmental bodies. Not that Congress was told about The System. If any Members knew about it, they weren't talking for public consumption. But they were inveigled into passing the Elementary and Secondary Education Act of 1965, the Public Works and Economic Development Act of 1965, and the Manpower Act, all which were loaded with funds - huge amounts of which eventually found their way into the pockets of the systemologists.

Once the preparations were in place, and the PPBS was ready for insertion in pilot governmental areas, cooperators were found at George Washington University to accept the unprecedented task of leading elected officials into acceptance of this scheme.

The resolution in California which legalized initiation of the PPBS there correctly labelled The System "revolutionary" although it was identified only as a new method of 'budgeting and accounting'.

The cooperators at George Washington University (GWU) gave a perfunctory bow to the 9th and 10th Amendments to the United States Constitution, as they credited "representatives of the States" as the impetus for their "5-5-5 Project". Since those 'representatives' were in fact representing national organizations affiliated with the Chicago-based conglomerate known as "1313" (which has goals of its own), GWU involvement by-passed citizen or State consent.

The "representatives of the States" cited by the Director of the 5-5-5 Project as instigators of the 5-5-5 scheme were:

- \* The Council of State Governments;
- \* The International City Managers' Association;
- \* The National Association of Counties;
- \* The National League of Cities; and
- \* The United States Conference of Mayors.

These were later joined by other 1313 groups in support of the Project. Implicit in cooperation from the beginning was the National Advisory Commission on Intergovernmental Relations (ACIR). This is evident from the

presence of Frank Bane, then-Chairman of ACIR, as Chairman of the State-Local Finance Project Advisory Committee, which led the 5-5-5 Project to fruition. It was Bane who credited the Project with introducing "a new way of thinking" about government.

It is that new way of thinking which is at the heart of the problems citizens face when they confront such projects as the PPBS. That new way of thinking negates the principle of self-determination and promotes deception as an official and legitimate method of directing the public will toward imposed goals and objectives.

A report from the 5-5-5 Project reveals beyond the shadow of a doubt that existing organizations composed of both elected and appointed officials, supported by the public purse, are actively pursuing a lethal course for this nation. The 1313 connection is the fountainhead of the pollution of our government, and it is in 1313 that means of correcting the problem will be found. It is in 1313 that the true purpose of the PPBS surfaces. That purpose relates to the 1313 goal of a totally managed and controlled society, replacing the tried and true historic, lawful system of individual planning under which this nation grew and prospered.

As centralization of control takes place through social, economic and political planning, the infinite decisions of the private sector are transferred to 'government'. The logistics of control become unmanageable. A single authority assuming responsibility for the myriad decisions once made by millions of individuals, must find a way to coordinate those decisions.

The so-called Planning, Programming and Budgeting System is the way the would-be controllers devised.

As the helix of regionalism, by its nature, must expand to encompass the globe, so, also, must the control system required to devise the strategies for incorporating the myriad "local" plans into a single whole.

No wonder, then that there was an undercurrent of excitement below the surface activity of those who were developing and implementing the PPBS! It is a heady business, participating in a movement intended to control the world and all of its inhabitants.

Addendum:

"Implementing PPB in State, City, and County - A Report on the 5-5-5 Project"; State-Local Finances Project of the George Washington University, 1969.

U.S. News & World Report, "Will Computers Run Future Wars?" 23 April, 1962

## THE ULTIMATE WEAPON - 80 - The Shibboleth of "Local Control"

No headlines bannered the decision reached by a Special Committee of the Indiana Legislature on the 16th of October, 1975. That decision was of historic significance, but it could not be expected that the Media would report that fact.

For the very first time, anywhere, elected officials, after a comprehensive, objective study of the Planning, Programming and Budgeting System, had voted against it.

That decision was not, as one Indiana paper announced, simply "rejection of a 'budgeting and accounting' system which would tie Indiana's public schools to the United States Office of Education", though if that were all, there would still be cause for rejoicing. But the ramifications of that vote were incalculably larger than that.

Four years before, Indiana's Legislature had been conned into approving a bill requiring a new system of "budgeting and accounting" for the State Schools, just as was done throughout the several States. Just as was done everywhere to get the machinery of the PPBS rolling, Indiana's legislators were sold a bill of goods, without any adverse information.

That bill became Indiana Public Law 309, and it mandated compliance with a new system for "budgeting and accounting" by all local school districts under penalty of retaliatory action by the State. The system was to be developed for all local districts in Indiana by an appointed Commission on General Education (CGE) created for that purpose. No further legislative review of the action of CGE was required.

That mandate was a blank check for the proponents of the PPBS, with no oversight by the elected officials. Whether that Commission followed the California strategy and hired a firm specializing in systematic applications is not disclosed in the documents available for this report, but the odds are that it did.

Recognition by the Legislature of what the CGE created under the mandate of PL 309 was slow in coming. Citizen concern began to grow as a result of the evidence provided by implementation of the PPBS in the Districts, and because of information received from California about the true nature of the PPBS. Turning to their state representatives for explanation of the authority given for this "budgeting and accounting" system to alter the purpose of school programs, the citizen demands caused the Legislators to create this Special Interim Committee to examine the program developed with CGE direction.

Under the able leadership of State Senator Joan Gubbins, the Interim Committee met throughout the summer of 1975, taking testimony from the public, as well as from the officials who were implementing The System. The public testimony was overwhelmingly adverse to The System, and substantive information was presented which justified the opposition.

Finding merit in the case presented against The System, the Interim Committee met its responsibility regarding the PPBS as no other legislative group has done, either prior to its Finding, or since. In so doing, it gave the citizens of Indiana the first opportunity anywhere in this country to confront their legislators with the real issues of the PPBS, thus permitting an informed decision on The System.

For the very first time, a legislative body was going to vote on the PPBS with full knowledge available as to the nature of The System, its capabilities and potential. Until then, no such body, possessed of full

*Commission on General Education*  
VI - 36

knowledge, had been asked to "bite the bullet".

What an example was held up to the shilly-shallying legislators in California by the action of that Committee in Indiana! The massive citizen campaign in California (aided by one lone assemblyman), to force examination of The System was aborted in every confrontation by the commitment of the proponents of the PPBS, with the prestige of the Governor's Office, the compliance of the State Superintendent of Public Instruction, and the State Attorney General providing support.

That Committee in Indiana provided an example as well for Texas' legislators, who supported the "Goals for Texas" despite the integration of the PPB in those Goals; for Maryland, where State legislators supplied the PPB training to the Baltimore Regional Planning Council's scheme to inaugurate The System in that region, even while the PPB was being inserted into the State government; for New York, where State officials offered the whole State as a pilot for PPB development, just as was the case in California, Wisconsin, Michigan and Vermont; for Ohio, where elected officials looked the other way while Dayton joined the "5-5-5" pilot project; and for all the other States, cities and counties who now are in full participation in this fraudulent scheme.

If the Indiana Legislature as a whole had followed the advice of the Interim Committee, a major step would have been taken toward relieving the education of the children in the public schools from the central control which The System supplies. If just one State would deny implementation of The System, that would break the chain which provides the linkage for the total system.

It is important that every caring citizen of these United States know what happened in Indiana, for the strategy of subversion used there to abort the intent of the Legislature has become Standard Operating Procedure wherever there is an effective challenge to any aspect of The System.

Only the greatest respect and gratitude are due to Senator Gubbins for her courage, competence and sheer hard work in conducting the extensive hearings required for a true understanding of the PPBS, and for taking the resulting decision to the full Legislature.

The Indiana Chapter of ProAmerica, which, under the able leadership of President Jean Harvey, sponsored Citizen Forums to bring the work of the Interim Committee to the attention of the public, also deserves the highest praise for their outstanding citizenship.

Despite all the effort which went into bringing this System to public scrutiny; despite the clear intent of the State Legislature to respond positively to the request that The System be recognized in its totality, the forces promoting it still won the battle.

For the unprecedented opportunity to break the linkage of systematic subversion was sidetracked, and the Legislature was encouraged to simply remove the MANDATE for The System, without denying implementation. This was the same strategy used in California. By the time the bill from the Indiana Interim Committee reached a vote by the full Legislature, it had been modified to permit local districts to implement or reject The System, under "local option".

Local option is an innate part of representative government, but it can be devastating in a revolutionary situation.

Under the Constitution, local decision making is the cornerstone in the foundation of liberty. In the process of implementing the "impossible dream", 'local option' has become a mere shibboleth. There is now massive acceptance of the "management" functions of The System among intellectuals,

particularly those whose lives are tied into 'education'. "Local control" in education, was an early casualty of the assault by the Rockefeller General Education Board. (See "Suffer, Little Children")

In California, there is a printed record of the deliberate, determined scheming to "prepare educational planners" prior to any overt move to put The System in place in education. School personnel were trained for systematic application; programs were developed to use The System; textbooks designed to apply systems techniques to the learning process were adopted; computers were installed to operate The System. Everything was "go", before there was any authority for implementation. There was no REAL "local option".

The results of that Indiana decision to give "local option" free reign in the matter of The System, as well as the evidence of systematic subversion of the educational process throughout the country, suggest that these preparations for implementation were endemic.

The decision was made long before, and far from the local districts. Indiana's Legislators did not know that, though, as they left the door open for The System by not rejecting it outright.

The fact is that there is an intent for PPB implementation to place controls over every facet of human action. If this is accomplished, the ages-old dream of Everyman for human liberty will fade into the mists of the past, and the impossible dream of a worldwide control by a self-appointed group of megalomaniacs will be the new reality.

One of the few people who recognized what was being done to American "prisoners of war" (POWs) in Korea, Edward Hunter, graphically described how the technique he named "brainwashing" was also used on an entire population in China.

Hunter had been a journalist, a foreign correspondent, reporting on the far east. Like Don Bell (and many others who reported what they saw, whether or not it followed the media "line"), when he returned to America, Hunter found that, in order to retain his integrity he could no longer write for major outlets. He started to publish a private newsletter, free from the constraints of the "kept" press.

In 1971, a lead article in one of his newsletters (Tactics) opened several lines of thought not usually considered in reference to managed news. It was a significant article, and leads to further speculation about the subject matter.

Telling of his own days as a cub reporter, when "journalists" were "newsmen", who learned the business from the bottom up, and were proud of their profession, Ed Hunter pointed out:

"Now they have to be products of campus and college indoctrination, and usually have graduated from some school of journalism as well... Newsmen believed then (when he was starting out) in telling a story as it literally happened. Now, they engage in so-called interpretation...and, in so doing, today's "journalists" have lost honor along the way."

One of the first pieces of advice given a cub reporter is "never play down a big story", which is fine, as long as the story is truly told. Today's "journalists", however, often stretch a story, over-emphasize it, minimize its importance, or consign it to the round file, for purposes other than information. This is a basic reason why the news media is in such disrepute today.

In such a case, a value judgement has to be made, and, too often, the judgement places on the front page whatever lends itself to downgrading the United States, its real image, or merit. Sometimes that 'judgement' censors or suppresses stories which favor the plusses of the American position.

Hunter said that today's reporters, editors, and columnists "become so blinded by anything which contradicts their big story...that they fail to recognize treason when it stares them in the face".

It could be fruitful to pursue the line of thought about schools of journalism, and perhaps determine how much of that blindness can be laid at those doors, for such schools typify a trend in every career field today.

Where, previously, each profession had apprenticeships, on-the-job-training for youngsters fresh from farm or public school, to be journeymen, and then artisans, today, these schools do that training.

Given a desire to make over the world, no better method could be found, than to channel fresh young minds into schools of indoctrination, where they can be conditioned to use their talents, and their profession, for a dual purpose. An old saw has it that "Them as can, does, and them as can't, teach". Why wasn't it better for the youth to learn from those whose



proficiency was established, rather than from theorists? Could it be that there was another reason than learning a trade?

Until about 20 years ago, the independent papers which still served local communities with integrity, became the new "mass media", as word got around that they proudly continued to fulfill their responsibility of helping to sustain a free society by accurately reporting hard news. Most of the editors of these small papers were also the publishers, who learned their trade as Ed Hunter did - in the school of experience. They knew, respected, and loved their profession.

As the major media increasingly served a different master than the public, "letters to the editor" from readers throughout the United States began to appear on the OpEd pages of these small, local papers. Tiny towns in California, the Ozarks, Illinois, and elsewhere, became known to citizens in every State, because they reported news not found in the big city dailies.

Unfortunately, many of these local papers, run by patriotic, responsible, newsmen, were in jeopardy. Caught in the bind of escalating costs, minimal advertising, and an other-oriented society, many of them could not bring in enough money to make ends meet. Most of these papers were dependent on older professionals to retain their character, and the handwriting was on the wall. There was no band of talent, trained as they were, on line to follow in their footsteps. When time caught up with them, there would be no one to pick up where they left off. At some point in time, the day comes when these publishers are no longer able to carry on. What happens then?

Many papers, still seemingly local, are already affiliates of national combines, and, except for local news, print only what comes to them as "canned editorials" and features. Even local news is colored by editors who hold their jobs because they don't 'rock the boat' by truthfully reporting what local officials say, or fail to say, are or are not doing, in regard to the larger issues of the day.

By such reporting, citizens are denied the knowledge they need to become aware that the "big" problems they read of in the "big" papers, or hear on radio or TV, are, in fact, growing from seed in their own backyard.

Citizens are denounced as "apathetic", when the truth is that they are not receiving the information necessary for them to protect their liberties.

Those editors who fail in their bounden duty to report the news would deny vigorously that to "remain neutral regarding their own country's life and death struggle" is a form of brainwashing, and an abrogation of their responsibility to report the truth, without fear or favor.

Too often, even those editors who are far from neutral, personally, cannot bring themselves to tackle 'controversial' issues, because they fear loss of community support. Any appreciable number of cancellations could make the difference in keeping the paper afloat.

Too often, that fear is justified, because too many citizens have been conditioned to reject controversy, or are less than enthusiastic about learning what is really going on around them. (If they knew, they might have to do something about it, and that might upset their routine.) In such cases, an editor finds there is no problem in hiring a reporter who has ties to environmental causes, or 'women's lib', but will not hire anyone who is known to oppose these issues, or who has made waves about any of the major issues of the day.

Your typical local publisher cannot 'afford' to give his readers anything but what they 'want', so let's hear it for the local garden club, the local 'boosters' club, the high school football games, and the PTA.

These present day 'local' papers won't play down the big stories - they will just ignore them.

## THE ULTIMATE WEAPON - 81 - The Secret Agenda

Any program which uses all the children in the public schools of America as guinea pigs is a dangerous experiment.

A Pandora's box was opened with the passage of the Elementary and Secondary Education Act of 1965 (ESEA'65). Under Title III of that Act (Public Law 89-10) just such a program was mandated by Congress.

Under Title III, oceans of "federal funds" flooded the country to create "regional centers" charged with developing "innovative" programs for the schools. By definition, "innovative" equals experimental. It could be expected that the educational establishment would respond with a will, but why State legislators would supinely allow this intrusion into their territory can only be answered by those who permitted it. Within a year the country was networked with such centers. From those centers came the implementation of the Planning, Programming and Budgeting System in the educational arena.

In addition to creating the components of The System, Title III also inspired hundreds of potboiler programs. The content of most of these strongly suggests that the federal funds they would bring in to a district were their only reason for being. Many of them held extremely questionable intrusions into the life of the child, and of the family. Next to pilot programs for systems application, "family life education" (sexed) was a major contender for second place in the responses.

In 1967, Congress amended the ESEA to require a comprehensive State Plan for Education, as a prerequisite for further funding. By then the States had grown accustomed to the flood of funds from Washington, and rushed to comply with this latest mandate to continue the flood. The California bill to comply was probably fairly typical of those passed in other States, so we offer it as an example of how legislators are willing to give up their Constitutional obligation to maintain State sovereignty in return for filthy lucre.

California's Assembly Bill 1865 was the chosen vehicle to bow to this latest revolutionary move in that State. AB 1865 states its purpose up front:

"It is the purpose of this chapter to join together the United States Office of Education, the State of California, and local school systems, to bring purposeful change and experimentation to schools throughout the State, through use of all available resources of the State."

Nothing could be clearer than that.

Our local public schools were to become an official part of a National Education System, which was purposefully to experiment with the education of our children on a vast scale - to bring about "change".

Considering the failure of the educational establishment to perform its expected duties which was so evident in 1965 that it was possible to enact such a bill as ESEA, it is understandable that some might say "It's about time for a change!" - if they were not aware of the change intended by those in charge of educational matters.

Under ESEA'67, it was also required that each State have an 'advisory council' as part of the State Plan. In California, that Council was called

The Educational Innovations Advisory Committee (EIAC), and EIAC was the principal channel for inserting the PPB in the State school system.

It being the nature of bureaucracies to expand their power and influence, these advisory committees were no exception. In almost no time they had formed a national committee of State Advisory Committee Chairmen, to share their successes and failures, and to work out 'problems'.

At their first meeting they heard some very interesting remarks from a most surprising source. Congressperson Edith Green of Oregon was a qualified liberal, yet she surprised her audience with some warnings about their enterprise. She said that experience in Oregon had shown that, if there were 50 problems when officials from the federal Office of Education (OE) arrived, there were 100 when they left. A later speaker, Roy Warner, from the OE told these innovators that there had not been much hard evidence of success from the innovative projects, but that if success had to be the product, Title III would serve.

Among the stated purposes of forming that national association of chairmen, were:

- \* to assist all State Advisory Committees through exchange of information on procedures and promising practices;
- \* to improve practices;
- \* to improve the environment for innovations (create a climate for change-ed.)
- \* to establish alliances with other groups and agencies to support innovations.

Where was the commitment of these 'educators' to the children? It was not there.

WHERE is the organization which will establish alliance with groups and individuals who are determined to resist creation of a total federal monopoly of education?

What share of the public purse is available to monitor these untried programs?

Who will assist in exchange of information as to the costs of these innovations - in terms of damage to innocent children, as well as financial burdens on their parents?

How many citizens know that their children are to be the victims of such a monumental experiment?

This secret agenda was helped to remain a closed book through the tactic of giving the programs names which had acronyms that could be used for reference, thus hiding the nature of the program. There was a grim humor within the establishment in working out titles to be used this way. Thus PEP replaced Preparng Educational Planners. The acronym upbeat, the true title a giveaway. PER a soft sell for Planning, Evaluation, Research. PACE (the generic acronym) for Projects to Advance Creativity in Education.

Two "experts" were brought in to set up the Northern California Regional Center (ERA - Educational Resources Agency). In a prepared statement these two noted that the educational system was caught in a "cruel dilemma". They claimed that "changes in social and economic forces" and in "attitudes of the citizenry" posed "a challenge of horrendous proportions" to educational institutions which needed to plan for change in order to respond to it. In three short paragraphs they used the words 'change' or 'changing' nine times. And so they came to California to solve

its problems with a three-stage cycle for "developing an organizational strategy" to fit that state into the world of the future.

There were no hearings held about setting up this regional center. It was casually brought up at local school board meetings as simply part of the agenda. The most avid government watchers were unaware of the portent contained in this agency which held such tremendous import for the future of their children, themselves, their State, and the entire nation.

Once formed, the NCSACC (National Committee of State Advisory Committee Chairman) backed off into the shadowy world where the secret agenda of Establishment programs are shaped and molded until they are ready to be handed to legislators for implementation.

THE ULTIMATE WEAPON - 83 - The Pragmatic Application  
of Deceit

The unbelievable reaction from the legislators in California to exposure of the PPBS made it necessary for citizens to seek answers to such questions as "Why do none of them accept the copious evidence?"; "Why is there such a System?"; "How did it emerge fullblown, with so little knowledge about it?" - and a hundred more.

It was a laborious chore, digging out the origins of this long-secret program. The legislative trail, just in California, was found to lead all the way back to the early 60s. At this late date, it is a practical impossibility to place a marker on the first penetration in other states, but there is reason to believe that California led the way in this, as in so many other pilot projects for the New Social Order.

The earliest State legislative record we found was a report from the California Assembly Interim Committee on Education in the mid-60s. As was proved to be the fact so many times, unless one knew about The System, and knew the euphemisms used to disguise it, that report would have given no hint of what was really being discussed.

Titled "The Tangled Web", that report was a masterful example of the pragmatic application of deceit. If you remember the old doggerel which contains that phrase, the very title of that Report proclaimed that to be so. For those who may not remember that old saw, it goes:

"Oh, what a tangled web we weave  
When first we practice to deceive!"

Deceit has been the hallmark of the progress of this revolution from the beginning. It was used in the 1913 grand slam, when the federal reserve, the progressive income tax, and the direct election of Senators were smeared across the face of the Constitution, and deceit has been a constant blotch on the fundamental law of our land ever since.

Deceit was needed to forward the programs of the SEB/GEB (See "Suffer, little children"). It was present in the transfer of the money center from the Congress to the executive in the Budget Act of 1921. It was there when the first attempt was made to establish a Federal Office of Education in 1923. Hidden in that bill (HR 2923), behind the many more easily recognized radical retreats from traditional, local education policy, was a Call for "a great national research agency" to "make studies, and collect facts and statistics" for "the benefit of education". These descriptors are still being used to denote the presence of The System in many of the implementing documents.

Deceit was implicit in the programs for education which Congressman Shafer documented in 1951\*, and in the related programs the Hon. John T Wood of Idaho documented that same year, which he described as "the greatest subversive plot in history".

Deceit was essential to passage of the National Defense Education Act of 1958 (NDEA'58), in which the groundwork for The System nationally was laid, for NDEA'58 began implementation of "data processing". NDEA'58 was also the first major statute which succeeded in using "federal funds" to force the States to accept federal mandates.

Deceit and indirection accompanied the effort to create "A Federal

Education Agency for the Future", the 1962 version of the 1923 Federal Office of Education. The late, great Congressman from Ohio, John Ashbrook, led the opposition which pushed that one off the schedule.

Pragmatism, indirection, misdirection, semantics and a callous disregard for legal constraints have characterized the entire history of this subversive plot. No wonder it has come so close to realization! But the truth is a matter of record and cannot be gainsaid. It exists in the minutes of committees, commissions, and boards; in reports, master plans, laws, executive orders; in contemporary books, magazines, and periodicals. In most of these an artful presentation needs decoding, but the facts are there for the serious seeker. Once The System is recognized, it is nothing short of amazing how it emerges from the labyrinth of newspeak so clearly one wonders how it could have been overlooked.

Colleges and universities, public and private, have been used to develop the concepts, plans and programs, and cadres have been recruited there to carry The System to fruition. Thinktanks were created to adapt The System to computers, to develop practical applications, and to devise ways and means to circumvent resistance.

In 'government', until it was ready for installation, The System was advanced mainly through the Pentagon, and the clone centers it created to develop components of The System, with the approval of the executive, and the knowing or innocent collaboration of legislators and selected citizens who are appointed to committees, commissions and boards, where their cooperation is assured. If they are not already collaborators, they are made so by using the strategies of The System on them.

Elected executives in the States have furtively aggrandized their power and influence at the expense of the legislative bodies, which, in turn, have been suborned into relinquishing their mandated authority, responsibility and accountability by delegating the duties of their office to those 'citizens committees' and appointed "commissions".

Early efforts to 'sell' this subversion as a means of "economy and efficiency" were allowed a quiet burial, as economy and efficiency were demonstrably the first casualties on this front. Reports from the California Legislative Analyst, as The System became operative disclose an unbelievable profligacy, which legislators chose to ignore.

The estimated cost of insertion of The System in California alone, over the ten-year time frame of expected implementation, was put at \$98 million dollars, plus estimated annual costs of \$13 millions. ONE YEAR after that estimate was given the legislature, costs were exceeding \$30 million a year - or a probable ten-year projection of \$300 million - yet there were no screams from the Capitol! That same year, The System in the Federal Departments, according to the GAO (General Accounting Office), cost \$550 millions - and it was operating at two percent efficiency!

This scheme is a felonious attack on representative government, and a revolution within the form of that government.

It is more than that. It contains, as an essential element, an assault on the right of every man to determine his own destiny.

There is no way it could have reached its present status without the pragmatic application of deceit which has characterized it from the beginning.

Recommended:

"PPBS - Questions and Answers", 1971 - John Hart Reference Library





SUFFER, LITTLE CHILDREN - 84 - The Common Mind

"'Tis education  
"forms the common mind;  
"As the twig is bent,  
"The tree's inclined."  
(Author Unknown)

A tremendous influence in the course of this revolution was that of the tax-exempt Foundations. The Foundations were made feasible by passage of the infamous graduated income tax - spawn of Marxism. Were there no income tax, there would not have been the benefits which accrued from "tax exemption", and the malefactors of great wealth could not have put themselves forward as "benefactors" unless they used their own money. It would have been a hard decision for them, choosing between their impossible dream, and their gold.

One cannot help but wonder if there would have been this revolution, had not control of the Senate passed from the States to "the people" shortly before. Despite warnings that as a result of passage of that amendment, there was increased danger of the establishment being able to control Senators' votes, through generous "campaign contributions", protection of States' Rights slipped out of the hands of the Senate.

But that is now moot - the tyrannical tax is a fact; its 'benefits' a given - the Senate is no longer the watchdog of the 10th amendment.

And public education was the battlefield chosen by the Foundations on which to wage the war against civilization.

The dominant figure in the area of re-education for the New Social Order was John Dewey. From his position at Columbia University, and with the security which resulted from a lack of public awareness of the existence of a Plan and/or Dewey's role in it, he was able to perform what may well be the most important function of any single individual in redirecting the course of a nation.

Dewey popularized the "social science" movement among the 'intelligentsia'. Equally important, he was able to begin the penetration of what then were called "normal schools" in universities from coast to coast. His graduate students fanned out across the country - some to begin teaching the new ethic to the teachers who would teach the children of America; some to enter publishing companies, to prepare the texts which would emplant the new ethic in history (and in the future); some to obtain seats on the underground regional railroad - on school boards, in city councils, county boards, state legislatures - wherever their talent and/or expertise was needed.

But a bird needs two wings to fly, and the other wing of the re-education movement was the Rockefeller "General Education Board" (GEB).

In 1909, the bishop of Emory Methodist University in Georgia, Warren Candler, penned a polemic on a situation affecting his ability to direct the education of his students. He wrote:

"An educational trust has been formed, and it is operating to control the institutions of higher education in the United States... It proposes to change (America's) political thinking, religious beliefs, and social organizations, by a scheme to dominate their colleges and universities..."

Bishop Candler described his effort to bring his experience to public

attention as "an unheeded voice, crying in the wilderness". And it was. For, even though his testimony was later presented to the United States Senate when hearings were being held on the question of approving the charter of Rockefeller's General Education Board, it still was not heeded, and the Senate approved incorporation of the GEB.

It is important today to know what was in the Charter which the Senate approved, for the GEB worked its will on the education of future citizens of America for over sixty years. Out of the past, read for yourself the license given to that educational 'trust':

"The said corporation shall have power to build, improve, enlarge, or equip, buildings for elementary or primary schools, industrial schools, technical schools, normal schools, training schools for teachers, or schools of any grade, or for higher institutions of learning, or, in connection therewith, libraries, workshops, gardens, kitchens, or other educational accessories; to establish, maintain or endow, elementary or primary schools, industrial schools, technical schools, normal schools, training schools for teachers, or schools of any grade, or higher institutions of learning; to employ or aid others to employ, teachers and lecturers; to aid, cooperate with, or endow, associations or other corporations engaged in educational work within the United States of America, or to donate to any such association or corporation any properties or monies, which shall at any time be held by the said corporation hereby constituted; to collect educational statistics and information, and to publish and distribute documents and records containing the same, and in general to do and perform all things necessary and convenient for the promotion of the object of the corporation."

That should be enough to cause even today's pragmatic legislators to "view with alarm". But that was only part of the Charter. Under it, not only was GEB given control of the money Rockefeller donated for his purposes, but GEB could also require that the favored institution must supply 'matching funds', control of which automatically passed to GEB. Our readers will recognize that the scheme for 'revenue sharing' was this, devised by GEB, eighty years ago, now totally involved in the extended revolution taking place today.

Even editors who had previously been 'friendly' to Rockefeller (and there were not many then) had a problem with this latest 'philanthropy'. One of them reported of the Board,

"Its power will be enormous; it seems as if it might be able to determine the character of American education."

And it did. The New York Journal of Commerce editorialized:

"As a mechanism for controlling academic opinion, there has, perhaps, never been anything in the history of education that would compare with the (General Education) Board system of subsidized learning."

Senator George E. Chamberlain (R-Oregon) led the floor fight against the charter. He told the Senate:

"Give me, Mr President, the education of the youth of this country, and the control of \$100,000,000 or \$200,000,000 for a period of years, to do as I please, and I venture the prediction that in two or three generations I can practically change the ideals of America."

He hammered away at this point:

"...if you place the education of our children in the hands of men whose ideas are at variance with the ideas and ideals of most of the people,...there is no telling where it will lead... I do not pretend to say what the purpose of these foundations is... We do know that these men... connected with these foundations do not stand in the highest esteem of the present generation... but, if they can educate (the people) to take a different view from that which is taken...(in) this day...they will be looked on as great patriots and great philanthropists... Mr President, generations yet unborn ought not be permitted to look back on the past through any such refracted ray as that!"

Evidence of the results of legislative approval of the General Education Board was not long in coming. In 1958, the California Senate Committee on Education studied the history of the "revision" movement in the schools. It was found that public impact of the movement was beginning to be felt in 1921, when the Superintendent of California schools warned:

"I confess that I am becoming somewhat perturbed by certain tendencies in our schools that are anything but conservative."

And he had reason. Educational termites had begun the undermining process almost immediately on approval of the GEB. In 1918, one Mary P. Follett had published a book titled "The New State - Group Organization the Solution of Popular Government". From the record, this became the new bible for the revolutionaries. In it she opened the attack on representative government:

"The 20th century must find a new principle of association... Group organization is to be the new method in politics... the foundation of international order... 'Representative government', party organization, majority rule, with all their excrescences, are deadwood. In their stead... the bringing into being of common ideas, a common purpose and a collective will..."

Follett's solution was through the use of mind control (what we now know as "group dynamics") to obtain consent to her radical proposals.

Wonder no more about 'ancient history', gentle reader. The problem the late, great, Senator from Oregon saw so clearly in 1917 now haunts every action taken today - public and private.

Although the 'doctoring' of certain reputations was clearly a factor, as history records, that was incidental. The changing of the ideas and ideals of America for revolutionary purposes was the Goal.

Thanks to the perfidy of a handful of cooperators in the Senate, the Charter for GEB was granted. That approval of that Charter was a giant leap toward realization of the Elitist version of the 'impossible dream'.

Addendum:

Sixteenth Report, California State Senate Investigating Committee on Education, 1958.

At the turn of the century, there was a monumental task ahead for the self-appointed elite whose revolutionary goal was a world where "all the people yield themselves with perfect docility to our moulding hands", as they boldly stated in the first Occasional Paper of the General Education Board. From ivory tower theory to practical application lay a path fraught with pitfalls for their goal. The probability of being able to realize their Dream was miniscule.

But these men were fully aware of the difficulties, and they laid their plans skillfully and very carefully. Part of their strategy has always been to make a trial run, before putting any part of the Plan in motion.

They knew, too, the power which derives from wealth. Unhindered by moral or ethical boundaries, they used that money power in every conceivable way to achieve their ends. They used it to suborn cooperators. They used it to buy political collaborators and legislative compliance. They used it to finance scientific and educational endeavors which developed tools for them to use in their inexorable march to their goal. They used the money power to open doors in existing institutions, and to build some they needed which did not exist. They used it to drive wedges between traditional and legal bulwarks to insert their innovations. Once their pilot programs were established, the money power was used again to suborn acceptance of their schemes as essential functions of 'government'.

Just as, in recent years, their clones form semi-secret alliances (such as the Bilderbergers and the Trilateralists) to promote specific objectives, so did these early elitists. Their groups met at indeterminate intervals, probably discussed progress, received battle plans for the next foray, and those selected to put their schemes in action went out from their secret meetings to perform their assigned duties.

From the very beginning of this revolutionary movement, any strategy which was successful became SOP - Standard Operating Procedure. The first thrust is always at a target with the least ability to resist. In California, for instance, welfare recipients were the guinea pigs for the first trial run of the PPBSystem.

So it was from the beginning. Before the GEB, there was the SEB. The Southern Education Board was the pilot for the General Education Board.

In the post-reconstruction period in the South, the made-to-order guinea pigs were the descendants of the "freedmen". These were in deplorable straits. "Integration" was not even part of the vocabulary in the South then, and intermingling of the races was anathema to both the negroes and the whites. The former were only too aware of what slavery had been, and the latter too well remembered reconstruction. Neither wanted to depend on the other for anything. But integration was a prime aim of the SEB, and it went to work with a will on the negro children in their separate but far-from-equal schools.

In the circumstances, any change HAD to be for the better. Give the devil his due. SEB made a marked improvement in the "colored schools", and gave the children in them an incentive to begin to learn. But, as was said, SEB was only a pilot for the GEB, and once SEB became viable and visibly a benefit, the General Education Board was created, with a much broader base, and much more comprehensive purposes, and a much more receptive public.

A chronicler of Rockefeller philanthropies\* chose to assert that the family worked on these projects with "a degree of anonymity", and that even the absence of the Rockefeller imprimature was "symbolic". What it actually did was to create the semblance of SEB/GEB being quasi-governmental. In time, most people came to believe that these WERE governmental bodies. Those who served the cause were content with that.

Once both Boards were operating, it became hard to draw a line between SEB and its activities, and those of GEB. Both Boards were manned mainly by the same people, their programs followed the same pattern, and, once GEB was formed, the funds for SEB came directly from GEB. SEB was finally absorbed by GEB in 1914. While both were operative, hundreds of meetings, thousands of speeches, and tens of thousands of news articles conditioned the public mind to accept what they were doing - or at least what the trustees would have it believed they were doing.

When state legislation was needed to further some program, the trustees wrote the bills, a cooperating legislator would "author" them, and they or their minions would lobby them through the legislatures. There are indications that the money power served here, too. In at least two instances, public servants who had opposed some part of the scheme, but did not press their opposition, later turned up on the Rockefeller payroll.

Always cognizant of the truism that "who pays the piper calls the tune", constant effort from the start was to obtain tax support for the lower schools. Once that was in the works, the push began for tax supported high schools.

Rockefeller money paid a professor at the University of Virginia for organizing and promoting this move. To give the professor extra leverage, the State was induced to make him an official in the school superintendent's State office - the first such in the country. He was so successful in his appointed task, that this, too, became part of the revolutionary strategy. Gradually, State departments of education grew into the bureaucracies we know today, as new officers were added at that level to interface with local districts and the State legislature, and to oversee whatever promotion in the interest of GEB might need their special expertise.

Virginia first, then North Carolina, Georgia, Alabama and Tennessee were organized by GEB in rapid succession. Then South Carolina, Florida and Louisiana; Mississippi and Arkansas. One by one, States joined the movement, until it became a flood. It was claimed that these organizers were not professionals but idealists - evangelists, crusaders. And it was decried they were impeded at every step by "conservatism and prejudice".

In 1905, Georgia led the way into what is known today as "a public education system" with the first state constitutional amendment to permit taxation for public high schools.

This achievement was hailed in the press of the day as having "valiantly carried out the intentions of the voters". In truth, it was due to a well oiled, fastidiously orchestrated, campaign of the General Education Board.

While that campaign was being brought to fruition, GEB was not neglecting its other objectives. It was formalizing its strategies, training new recruits to pursue their objectives, and institutionalizing the controls needed to hold the gains they made, even as they continued to advance their cause.

With their goal in mind, GEB agents began to penetrate other fields than education - literature and all the arts, the news outlets, science -

even the government itself. To fulfill these objectives, the concept of 'philanthropic foundations' was created, with philanthropy a tool designed to hide the true intent and purpose of their activity. This is the only logical conclusion which can be drawn from the record. That record is not only from the activities of GEB, but includes the known past of its founders, their own statements, the self-serving biographies which they caused to be produced, and, of greatest importance, the results of their "philanthropic" endeavors.

While Rockefeller's penetration of the schools was progressing, another self-made billionaire was doing his thing in a parallel endeavor. Andrew Carnegie shared the Dream.

Rockefeller seemed almost indiscriminate in the distribution of his 'grants'. But wherever his money went, controls went with it. Each 'donation' had a purpose, always related to the Goal.

GEB funding was directed mainly at two key objectives, both vital to the Plan. One was the transfer of the local financial base of the schools from the parents to the State. With the transfer went local control. The other was the redirection of the purpose of institutions of higher education - public and private. It was the activation of this intervention which was felt by Bishop Candler.

Carnegie, on the other hand, concerned himself with institutions of higher education which were already publicly supported, and, of course, the "free" public libraries. Between these two giant fortunes, all American education was in the grip of a pincers movement, for a single goal.

This strategy diverted attention from the totality of the nature of the attack, and it is still in use today.

The Rockefeller/Carnegie cooperation for penetration of the schools continued as a "pincer movement" just so long as it served its purpose. When the time was ripe, Carnegie openly associated with GEB, even serving as one of its fifteen trustees. By then these two foundations had applied pressure from the two enclaves already captured, and their selected objectives were achieved.

The methods for supplying future citizens of the United States of America with the basic tools needed for productive life had been replaced with programs adaptable to conditioning them to accept the indoctrination needed to make them docile robots in service to the cause, and the funding for 'education' now came from 'government'.

What had been done was to wrest control of education from the parents, and vest it in the 'government'. While this was being accomplished, penetration of the government was proceeding at every level, with the objective of placing the control of the law-making machinery in the hands of selected officials, who would represent the interests of the elite - not the citizens who "elected" them.

The next objective was already targetted. A separate Department of Education at the federal level had been a continuing objective, and it now became a top priority.

In his polemic, Bishop Cantrell enumerated the conditions GEB tied to a grant offered to "a Southern institution". He did not name it, but the probability is that it was the one he headed. He gave too many details for it not to have been his own experience he was relating. GEB offered the university he cited a paltry \$37,500 conditioned on the college raising another \$112,500. If the offer were accepted, the college was mandated by GEB to invest the entire sum (including the \$112,500), and to forever preserve that investment for the purposes of the GEB grant. Those purposes

included denial of any part of the fund for theological pursuits - and Emory was a Methodist school.

Should any part of those monies be used for any purpose not included in those provided in the grant agreement, the entire fund would revert to GEB, including that raised by the institution! GEB was to have the right to inspect the books, accounts and securities of the college (apparently even those not involved in the grant), and was forever to have lien on both the funds, and the securities they might be invested in!

Of this offer, Bishop Cantrell said:

"The (GEB's) little wad of the pitiful sum of \$37,500 is expected to draw after it all the endowment which the college has or may hereafter acquire. It is set up as the prize fund, and the larger amount...given by others, is only a "supplemental sum"! ... With what threats of litigation or with what threats of withdrawal of funds might not the (GEB) control, under one pretext or another, the whole management and policy of such a college!"

While that particular grant was not accepted, the record suggests that Emory was among the minority in refusing that 'philanthropy'. A brief could be drawn for the right of a donor to specify how HIS donation should be used, but it stretches logic and ethics to find that right extended to cover existing funds or donations from others, who should have that same right.

Despite this record of perfidy, which was presented at the hearings for approval of the GEB charter, the United States Senate gave that approval. For sixty years, GEB worked its will on the public schools. When its programs had been institutionalized (seemingly irreversibly), GEB was dissolved.

Recommended Reading:

"Adventure in Giving" The Story of the General Education Board-Raymond B. Fosdick et al; Harper and Row (circa 1965)

"Treason of the Senate", Cosmopolitan Magazine, March, 1906, Book reprint, Monthly Review Press, 1953

SUFFER, LITTLE CHILDREN -- 86 - "Attacking the Schools"

Sometime ago, the Barbara Morris Report discussed a book titled "Citizens Committees". Printed in 1954, this publication admittedly was intended to "guide public thinking" about the policies for education in public schools. The book went into some detail about the use of citizens committees to guard the schools against "attacks", and the BMM Report asked the question:

"WERE parents really attacking the school in 1954?"

The answer to that question must be equivocal, as will be shown.

The very existence of such a book is indicative of the fact that the GEB plan for the public schools had taken hold and begun to impact the children then in school to the extent that their parents recognized an aberration from what the schools did when they were children.

That book affirms that those in charge of the schools in the 1950s stood ready to defend at all costs the 'advances' made during the years GEB was working its will on them. Since the best defense is a good offense, the schools had devised a strategy to inhibit opposition and to take aggressive action to rebuff it.

It can only be realized how vital that information is, when it is remembered that some of those children in school in 1954 may now be the grandparents of the children in school today. If their lives have been spent looking through the "refracted ray" of Rockefeller brainwash, there is a very real problem in trying to obtain their help in a return to basics.

The philosophic recognition that "a long habit of not thinking a thing wrong gives it the appearance of being right" has been a truism, which may not apply any longer. Many of the children who have gone through the propaganda mills known as schools are yet able to recognize that something is terribly wrong today, and some are striving mightily to correct the ills they see.

That is a bonus, but there is another side to the equation. Lacking a knowledge of where the schools went wrong, they do not know what to correct, or how to correct it. So they blindly flail out against what they see as wrong. They do not realize that some of the solutions which seem to offer hope only add to the problem.

Somehow they must be supplied the ammunition they need to wage a successful battle. It is to the everlasting benefit of society that there are some who "fell through the cracks" of a not yet perfected scheme to mold the children of America into citizens who will accept the elitist Plans. The other side of that coin is that the Plan is now perfected, and unless it is neutralized, and that soon, there will be no turning back, no matter how many become aware of it.

As for Mrs Morris' question - WERE parents attacking the schools in 1954? As one who was so accused, I can truthfully say we did not think so. We thought then that the public schools were OURS, paid for with our money, and entrusted with the responsibility to educate our children. We thought the schools had a mission to prepare the tools for our children to use in building the competence needed to provide them with full and rewarding lives, in which as adults they would make the decisions which productive



citizenship would demand of them.

When the activities in the schools gave us every reason to believe that the stated (and historic) functions of the schools were not being supported, it seemed a parental duty to call those activities into question.

I remember I was taken aback, when I was told that things were different than when I was in school, and given to understand that I must not interfere with the education of my boys. The impression I was given was that our situation was unique. It was MY fault (or perhaps my son's) that he had problems. It definitely was not the schools' fault. What I did not know then was that every parent who tried to help with the troubles her/his child was experiencing was given the same routine. "Nobody else is having problems."

We were so vulnerable. For most of us, in 1954, it wasn't any philosophical difference, nor any knowledge or suspicion that the schools were deliberately denying our children the education we had every right to expect. It was what we saw as a bad impact on our individual children. That parochial view was encouraged by the schools. It minimized a possible coordination among the incipient opposition.

More and more, the things which were really wrong are being identified today, by responsible, competent authorities. Today, two generations have been robbed of their birthright - growing up inadequately prepared for the realities of life - denied knowledge of their roots, and unable to seek that knowledge because they were not given the tools to do so. What a tragedy!

No, I don't believe even now that parents were attacking the schools in 1954. As I look back on those times, I realize I, personally, was intimidated by the attitude of school personnel. Oh! the "conferences" I was called to have with the teacher or the principal over a small boy who had never been any problem at home, but seemed to be always in trouble at school! Instead of examining the cause of my boys' problems, those conferences turned into sparring matches, as I was made to understand that I was the problem (or he was).

As I look back, I can see clearly now that the programs my son was given were really designed to retard learning. He was such a bright little fellow; Dick and Jane and Spot bored him to tears. (Literally, sometimes.) He was denied the right of initiative. When his eagerness for learning made him forge ahead of the class, he was assigned to teaching a retarded boy in his class, to keep him busy. (He was only seven.) The "field trips" which squandered precious learning time looking at fire engines, or visiting some local monument; the hours of "art" - pasting pre-cut shapes together to make pictures (an activity he had outgrown before he entered school); the exposure to "rhythm records", with their hypnotic beat (setting the stage for "rock?"); "sex education" setting attitudes of permissiveness, and giving dominance to thoughts of an adult process in minds not able to cope with such concepts. In line with that, the "experience learning", through which alien ideologies were embedded in the child mind. Debates by these untaught children on subjects about which they had only those facts the school had given them.

Even in memory I have to marvel that so many teachers found themselves able to waste themselves and those youngsters in such trivial pursuits, with so much of vital import available, and left untaught.

Then there was the sometimes overt, sometimes insidious, undermining of the values we cherished in our home such as the concepts of private

property and personal privacy, denied in the mandated "sharing" program.

Perhaps the most damaging of all the innovations in the schools was what is known today as "situation ethics" - the denial of distinction between right and wrong. This denial has been the key to the chaos and confusion which is making a shambles of the world those children went out into when grown. For, just as planned, they took these alien ideas with them when they left school.

Under it all was the inculcation of collectivist thought, perhaps best exemplified in the story in an early 50s reader, about a little gray squirrel who lived on the grounds of a big white house with a little red door. Often the little boy who lived in the house would feed the little gray squirrel. One day when he didn't come, another little squirrel went up and scratched at the red door, and the boy came out and gave him a nut. "Aha" thought the little gray squirrel, "now I know how to get my dinner. All I have to do is ask for it."

Singly, each of these had roused some parental protest. Together, they add up to a generic denial of the true purpose of education.

WAS it "attacking the schools" to call attention to these concerns, and to attempt to stop them? Do you think so? There was no concerted effort by the authorities OR by the parents to end these liberties being taken with the education of a whole generation of American children. Looking back, I marvel why there wasn't.

It was not until the Pasadena story broke into the headlines that parents suddenly began to realize that they weren't alone; that there was a very large concern, indeed, and with cause. The Pasadena Story is important here only because it was the catalyst which made visible the interlocking purpose of all these "innovations". By sheer accident, the problems in Pasadena brought them into focus, one after another.

Until then, the schools had been attacking the parents, without justification. Pasadena exposed the connection and intent in these programs, and parents then began to join in study groups and action programs, in the hope of ending the usurpation of their authority by the schools. EVEN THEN, though, there was no intent to "attack the schools". All the parents wanted was an adequate education for their children.

It has remained for those children, now grown, to mount a real attack on the schools, as they bravely campaign for alternative, private schools for their children.

You parents of today, you have a hard task ahead, but you have accepted the challenge, and you are handling it well. Because you are, the attempts so many of your parents and grandparents tried to initiate back in the 50s are made worthwhile. We thank you for that.

We hope that the information in this book will aid in your efforts, and pray that your children will be spared the agonies your generation had to endure, because the parents of the 50s had no way of knowing why the schools were doing what they were doing.

"I believe that a movement which arrogates to the educational profession - or to any other profession or segment of our national life - the awful responsibility of "social reconstruction" is subversive... I believe that a movement and a philosophy which aims to convert the public schools into agencies for promotion of a supranational authority or world government...is subversive... "

When Congressman Paul Shafer of Michigan made the lengthy statement from which the above remarks were taken, he had been elected eight times from the Michigan district he served. Now his seat in Congress was threatened by members of the Michigan Teachers Association (MTA), as a result of those remarks about what he called "a subversive movement in the public schools".

Challenged by representatives of the MTA to retract his charges, the Congressman instead requested a meeting with the MTA to discuss the research he had done. He assured the members who called on him that he was not making a blanket criticism of the teaching profession, but said that the teachers should be aware of

"...movements afoot in educational circles which are dedicated to the promotion of a planned and controlled economy and... a world government."

And he promised to document every charge he made.

Curiously, after the meeting he was requested by two prominent members of the Association to "let the matter drop". Convinced of a clear and present danger in the "subversive movement", Paul Shafer refused to do that.

Instead, he contracted with LongHouse Publishers to publish his meticulous research. Shortly after beginning this self-imposed task, his beloved wife, who had been his companion and mainstay through the years, died. A few short months later, Paul Shafer joined her in death. His good friend and publisher, John Howland Snow, took the incomplete manuscript and research notes, and finished the book.

Titled "The Turning of the Tides", that book has had a constant demand through the years since 1951. Rather than becoming outdated, the material these two Americans compiled has become increasingly important, as events prove its validity. Many books have appeared since then which only tend to confirm or extend the facts presented in this one. But the subversion continues - only now the movement it described has become official policy - not just in the schools, but as the determinant of policies in the 'government' itself.

Those who serve that policy do so by abusing the authority delegated to them by the people they 'serve'. And that's the rub. For when Paul Shafer publicly documented that plot to remake America and the world through revising the curricula of the public schools and conditioning the minds of the children through the programs they would devise, it could have been stopped summarily. Not easily, but nothing worth while is easy. How much harder it will be now - when almost everyone in this country under 40 years

of age has known no other side of history than that provided by proponents of that movement!

The dilemma is not limited just by the knowledge those citizens have been denied, nor yet by the fact that they have insufficient information to protect themselves and their children in constructive ways. It is an American tragedy that many of those elected to office are in the same dilemma, and are the blind leading the blind.

Nor is that the extent of the dilemma. With each passing year, the numbers of those who receive this travesty called education grows, while the numbers of those who were born soon enough to receive the traditional opportunity for real education diminish.

Nor yet is that the whole problem. With the liberalized statutes on immigration, and the policy of "refuge" for those seeking asylum, a wholly new element threatens the future of this country. While these may be innocent of any desire to change America, most of them have even less knowledge of what made this country a haven than those who suffered through the conditioning in the schools. The possibility that these newcomers could be of help in the task ahead is not promising.

Nor is THAT the whole problem. The role of the news media in neglecting the traditional duties of that profession is a most important factor. So, too, is the extent of penetration of that "subversive movement", in both the schools and in 'government'.

For America to "turn the tide", all of these obstacles must be overcome. They can be, but it will take real dedication on the part of every caring person committed to the concepts which are embodied in our Constitution.

Some must always be "extreme" in situations like this. There must be some willing to do more than their "share", pay more than others, deny themselves when others will not. It cannot be expected, even in the face of a clear and present danger, that all Americans will rally round the flag. It is always a few who carry the greatest part of such a load. But what a difference those few make!

That difference can be - and will be - felt worldwide, but its greatest impact will be felt where the greatest attack has been made, because the citizens of the United States had so much more to lose!

#### Recommended Reading

"The Turning of the Tides" - Paul Shafer and John Howland  
Snow, LongHouse, 1951

SUFFER, LITTLE CHILDREN - 88 - Participatory Democracy

"The question of how responsible officials could...delegate authority and responsibility imposed on them by law, or how...committees could, in turn, accept the responsibility and authority is not clear..."

In these words, Congressman Paul Shafer slashed away at the veneer of the then-new movement demanding "citizen participation" in government decision-making. In the early 50s, such a concept was shocking, it was so far removed from both precept and practice.

The Congressman pointed out to his colleagues the dangers he saw in such democratic deviations from the government provided in the Constitution, and specifically cited the Federalist Papers, with its careful study of the history of democracy.

Despite the bleeding hearts who mourn the "undemocratic" features of representative government, lawfully, ours is still a republican government, and there has been no argument yet put forward to induce the citizenry to deliberately change it. There were good and sufficient reasons for creating it that way, and most Americans to this day still find them valid.

In its best use, "participatory democracy" denies some degree of their delegated powers to officials elected to conduct the public business. At its worst, "do-democracy" (as it was called in its early stages) opens the door for mob rule. Today, that can mean that a small body of determined partisans can control the will of the majority, not just by means of usurping the lawful mechanism of government, but also through esoteric mind control techniques.

In either case, by its nature participatory democracy constitutes a subversion of the representative process. This subversion demands the widest exposure possible, for it is taking place today on a massive scale, by systematic application, and involving a vast number of well-meaning citizens who are unwittingly lending themselves to causes they would in no way knowingly support.

Many (most?) of the programs now being activated in 'government' do not come from any expressed desire of the people. Those which do, often result from the hegelian principle, as 'solutions' to problems created to require the prepared response. As such, they do not come under the "consent" premise.

Far too often, these programs stem from the "1313" conglomerate, through the agencies set up to spread the administrative revolution. These agencies are frequently composed of officials who have been elected to some other office, and are appointed to one of the 1313 special purpose groups, where they learn the 1313 line, take it back to their own communities and begin its activation there. It is these nonrepresentative programs which are causing the breakdown of representation, and endless controversy in local areas.

There is a thinktank located near the University of Wyoming, which has developed some courses designed to help these public officials (and other professionals) take what they learn in the 1313 cells back to their communities, and get the programs accepted. The thinktank is called "The Institute for Participatory Planning", and its purpose is to develop programs in "applied research", and to instruct those who seek their help in methods of practical application. The Institute has developed special short courses particularly for officials who can only be away from their

legitimate jobs for limited time periods.

Just the titles of the "short courses" are mind boggling.

Who, on your city council, or county commission, or in your state legislature, do you consider a likely candidate for a crash course in "HOW TO GET YOUR MOST DIFFICULT AND CONTROVERSIAL PROJECTS IMPLEMENTED THROUGH A SYSTEMATIC PROGRAM OF DEVELOPING THE NECESSARY PUBLIC ACCEPTANCE"? (A one-day Executive level course.)

Who, in your community, do you believe would be willing to take the time and pay the fee, to attend a seminar on "THE INS AND OUTS OF THREE DOZEN CITIZEN PARTICIPATION TECHNIQUES FOR DEVELOPING THE NECESSARY PUBLIC ACCEPTANCE TO IMPLEMENT COMPLEX PROJECTS"? (A two-day Course. NOTE 3 dozen techniques!)

Who do you know who would be interested in a course on "PLANNING PROGRAMMING, BUDGETING AND MANAGING AN EFFECTIVE CITIZEN PARTICIPATION PROGRAM"? (A three-day Course on Systems technology.)

These are some of the courses advertised in the Institute's promotional handbook. It is perfectly clear that both the handbook and the courses were made necessary by the need to neutralize citizen resistance to programs and projects which patently are not wanted by the electorate. Is that really "consent"? Can there really be "consent" when acceptance is suborned through methods of mindcontrol?

According to the handbook, the Institute has given these courses to "public officials and other professionals" from all over the United States. The Director of the Institute boasts in the Foreword that their courses "manage controversial and unpopular programs so that they CAN be implemented" (Emphasis in original). How much plainer can it be said that the 9th and 10th amendments to the Constitution are being subverted?

If Congressman Shafer was shocked at the unlawful delegation of power he saw in 1951, what do you suppose his reaction would have been had he been able to know how that delegated power would be used 40 years later?

What is YOUR reaction?

SUFFER, LITTLE CHILDREN - 89 - The Incredible Hoax

Everybody knows that the problem with the brightest and the best of the young adults today is that "they go to college and turn left". Right? WRONG! Like so many things "everybody knows" today, that ain't necessarily so.

"Left and right", "conservative and liberal" are symptoms of a terminal disease rampaging through the American mind, unchecked. Those four words exemplify an art and science employed in the psychological war being waged today. They are part of the conditioning process that is silently eating away logical mental functioning. As cancer destroys the physical functions of the body, this mental equivalent is destroying the capability of reasoning.

What is at issue is semantic subversion.

Let's examine the facts. "Left and right" are tied to political concepts; "conservative and liberal", to economic concepts. While a preponderance of professors may be left and liberal, the normal reaction of youth to indoctrination by adults is rebellion. Logic would suggest that any attempt at the college level to gain youth's acceptance of the liberal left would have an equal and opposite effect. Something more than that has to be involved in "the problem" with those who enter the halls of academe.

What is involved is neither political nor economic, although it serves a purpose in both.

At the heart of "the problem" is the induction, at some point in the educational process, of the cream of American youth into the cult of elitism. The majority of the students who go into higher education, do so because they had demonstrated early in life that elitism could root and grow in the climate of their minds.

If that seems far fetched, consider: The parents of the children in government-provided elementary schools in the 1950s were at a loss to understand why cumulative records ("cum files") were kept in the school records of the students, and progressed with each student throughout the school years. It was never openly acknowledged (and usually denied) that this was being done, but word seeped out in various ways. One such leak came as the result of a statement made by a teacher that she could not understand why a certain child had been identified on his record as "incorrigible", when she found that child to be most cooperative. If parents haven't had their questions about those files satisfactorily answered as yet, it is because, had they known the reason, it would have blown the lid off the most incredible of all the incredible hoaxes yet uncovered.

It may seem like digression to jump to a discussion of humanism at this point, but it is very germane. More on the cum files, later.

Humanism is the soil which nourishes elitism, for elitism is a manifestation of the rejection of a Supreme Being, and, particularly, the Lord of the Bible Who created man in His image and gave him dominion over every living thing, except his fellowman.

Because elitism is of the essence in the revolution taking place today, and because it denies the dominion of God over man and provides the tools for man to take dominion over his fellowman, America's schools had to close the door to those religions which recognize a Supreme Being ruling in the

affairs of men, and permit only those religions which declare men Gods, to be admitted to school.

Now, take the University of Michigan (please!).

The President's Report of the first 25 years of the Institute for Social Research (ISR) there, contains some of the most alarming information relative to these matters available today. It concerns humanistic elitism, and the way it grew and flourished at ISR during that quarter century. It also involves the development of America's sons and daughters into agents of 'change'. This Report is the more alarming, in that it appears to have caused no alarm by its publication.

Over the years, there have been sporadic attempts to direct public attention toward what is called "social science", but its acolytes have made this 'science' a sacred cow of the "New Faith", and all efforts to dehorn it have been aborted. Previous methods of studying the history of man and the functions of society were absorbed into this new "discipline", and, in the process, were revised to support the elitist "vision of reality" with its excitingly limitless potential.

The practitioners of the new art and science of creating social change through manipulation of the people and forces which control change, were not about to let their vision be diminished by the anguish of those from whom the control had been wrested.

Like the Report of the Hoover Commission on Recent Social Trends, in 1933 (q.v.), this Report on ISR apparently fell through the crack of "cognitive dissonance" (see Chapter 71). The content of this "President's Report" could not be assimilated by those who had no key to the door to this discipline, so far was it from the way Americans view the purposes of higher education.

So what's the use of reviewing it now, so long after the fact? The purpose is to expose one more strategic area in the subversion of the American dream - an area which has received almost no attention from the resistance, but which is vital to survival of individual liberty. Subversion of the American Dream is still being served at the Institute.

Perhaps the most important lesson to be learned from this Report is that the war we are in is the right war, but is being fought on the wrong fronts. That is a principle reason why these revolutionaries continue to score, and those who oppose them are constantly in jeopardy. While heroic battles have been mounted against the evidences of the activities taking place at ISR (and collaborators in similar situations throughout the country), the processes by which the revolution is moved toward its goal are never touched!

This President's Report on ISR tells how its concept grew from a comparatively innocuous cell of isolated, doctrinaire, dissenters from the "laissez faire" philosophy which undergirds the American government, to a worldwide network of co-conspirators in change agency, during 25 years of uninterrupted activity.

While battles for the preservation of the Republic waged across America, in every state, city, town and school, the strategies and tactics which determine the outcome of those battles were developed in such centers as ISR, and no word leaked out about them, so no effective resistance developed.

Each of the Centers at the Institute is assigned a specific discipline for which a 'need' had been identified, to achieve the management and control of society. The Survey Research Center (SRC), as its name implies, is involved in development of survey techniques, which have been honed to a



sharpness that can slice into human behavior with a precision equal to that of a surgeon's knife sheering off a piece of human flesh prior to putting it under a microscope. The data (information/intelligence) needed to manipulate behavior is obtained from the surveys, conducted by such Centers as ISR, under the guise of "research".

At SRC, concentration has been heavy on cumulative research involving economic behavior. Data collected on the economic status of individuals and groups; on motivation, attitudes, expectations and aspirations, is then correlated with data on changes in income, assets, debts, and types of purchases, "contributing to the new discipline of behavioral or psychological economics". (Just such a discipline as could have been used to 'manage' the recent "gas crisis", or the subsequent "oil glut".)

SRC also conducts "experimental research", in which a situation is created, and the reactions of those affected by it are examined. One instance reported involved the scientific observation of the performance and attitudes of employees, when a new management system was introduced into their place of employment. This was undoubtedly the kind of research which developed the techniques used in "The Politics of Change".

As its name implies, the Center for Research into the Utilization of Scientific Knowledge (CRUSK), is involved in undisguised planned intervention. Here, scenarios are devised for the stated purpose of creating situations to obtain reaction from the target group, who are not informed of that fact. The information obtained is then used to develop guidelines to use in bypassing citizen resistance to "innovative social policy".

This part of the Report (on CRUSK) boldly affirms that its objective is to determine the kinds of changes needed IN GOVERNMENT, to effect the changes these mattoids want IN SOCIETY.

CRUSK has explored the use of managers in housing complexes as facilitators of social change; examined the relationship of "decision makers" and those for whom they make decisions, to resolve the problems involved in setting public policy; it has analyzed cost/benefits involved in development and maintenance (and waste) of human capabilities (sic!).

If all this doesn't create the impression that, at ISR, the 'social scientists' have concocted the equivalent of a giant laboratory, in which thinking, feeling, human beings are given the same tender attention that entomologists afford the insects they study, please walk with me into the Center for Political Studies (CPS), and that may convince you.

At CPS we are met with statements of lofty purpose and noble intent. No such declaration, however, can justify invasions of privacy; unauthorized information (data) files kept on unsuspecting individuals; surveillance on citizens and their elected representatives without authority; and the manipulation of "environment" to facilitate 'change'. All this is part of the work of CPS.

Nor can claims of "a higher morality" disguise the fact that these 'scientists' are hired as teachers. TEACHERS - able to open young minds to the world of knowledge, or to direct them into dead end streets.

These 'scientists' have no mandate from any legitimate source, to "determine links" between private (individual or group) decisions, and public (official) decisions affecting the course of a nation. There is NO acceptable link between such activity as is conducted at CPS by their own admission, and the operation of the government machinery provided in the Constitution of the United States of America.

When self-appointed 'experts' begin to tamper with the linkage between

the citizens of this country, and those they elect to serve them, the dissolution of that relationship is already begun. The process of eliciting information in that sensitive area carries the germ of 'change', and the implications of THAT constitute a clear and present danger to continuance of representative government.

It is to be hoped that this information on the ISR Report has begun to clear up the 30-year-old mystery of those insidious "cum"ulative files, which bothered parents, so long ago. Just as ISR acknowledges the necessity for collecting sequential information to provide the data on "changes in organizations and individuals, in order to have greater control over shaping the future" (direct quote from the Report), the collection of sequential information was (and is) needed to shape the future of the children in the schools.

For instance, the possibility of steering a given youngster into a predetermined niche might be thought to be impossible, at, say, age five. Given a year, or two, or four or more, of exposure to "positive" influences in the classroom, that youngster might have been made into a likely - or unlikely - candidate for "higher education".

Without the (sequential) cum file, showing where a student had moved in relation to the system, it would have been difficult to gauge malleability or adaptivity of any given child. That information is essential to successful integration into the New World Order or, conversely, to determine whether or not "the reflex of freedom" in a particular child was strong enough to resist all attempts to initiate him/her into the cult of humanism. By virtue of the cum files, students could also be early marked as nonadaptable, as in the case of the incorrigible boy.

And so the track system was devised, and counsellors were provided to channel the students into the course where the most benefit would accrue to the New World Order.

Anyway the impact of science on society is viewed, the end result is tyranny.

SUFFER, LITTLE CHILDREN - 90 - Who Is Tampering  
With The Mind Of America?

When Marilyn Ferguson wrote "The Aquarian Conspiracy", she performed a great service for those of us in the resistance who have cried "conspiracy!", and found ourselves ridiculed (or worse) for suggesting it. Ms Ferguson not only dares call it that, but she names names, places and groups involved in it. Since she is, admittedly, one of "them", none has come forward to deny her thesis. It would be hard to deny it, for so much of what she writes about is visibly part of today's world.

The problem is, she takes great pains to insist that her conspiracy just "happens" - that it is leaderless, and spontaneously individualistic, drawn into an inevitable revolution as steel is drawn to a lodestone, irresistably. Either Ms Ferguson is unbelievably naive, or she has deliberately created a coverup of the fact that this revolution is being conducted by a conscious assault on established institutions, human relations, and social, political and economic structures.

In "The Aquarian Conspiracy", she has pulled back the screen of secrecy which has obscured the existence of a subculture dedicated to "destruction and rebeginning" (quote, Rexford Guy Tugwell, '30s FDR 'Braintruster') - destruction of the established order, through a 'peaceful' revolution, and beginning of a totally managed and controlled world order.

Unattainable by any legitimate means, that revolutionary goal requires trained strategists and tacticians to develop battle plans by which it could be achieved, and trained troops to execute the plans, unquestioningly. None of this could "just happen". Creation of this network of collaborators was a first priority of the revolutionaries, and it provided a large contingent of the troops needed for the systematic conquest of the world.

The subculture which Ferguson treats so kindly, functions under the fictitious name of "social science", a term which didn't exist until a descriptor was needed to explain the overt evidence of its activities.

Only once, during all these years, has this insidious aparat been threatened with exposure. That was in the 50s, when a committee of Congress received an assignment to examine the role of the tax exempt foundations in aiding and abetting the accelerating erosion of the American way of life.

How that investigation was foiled is another story. It is relevant here to note that only the tip of that iceberg was exposed at that time. However, it was recognized by some, even then, that there was a great deal more substance than was ever revealed. Of vital importance, no counter-offensive was mounted. Had there been, this subculture would have been exposed long ago for what it is, the culpability of the Foundations in its support would have been established, and the revolution could have been stopped in its tracks.

What is important now is to refute Ferguson's premise that this network is "leaderless"; to demonstrate how it is nourished, how it extends its influence, and the processes it uses to achieve a predetermined goal.

If caring Americans are ever to capture the initiative in this silent war, it is vital that they know where the battle is being conducted, by whom, HOW it is being waged, and with what weapons.

"The Aquarian Conspiracy" answers a vital question which puzzled those

of us who tried desperately to apprise the California legislators of the fact that they had, apparently unwittingly, approved installation of a management and control system in the State government and the State public schools. Ms Ferguson identifies one of the effective New Agers as one John Vasconcellos.

John Vasconcellos was Chairman of the California State Assembly Education Committee, and the Joint Committee on Education, and he was, indeed, an effective champion of the New Age cause. He always had time (as few legislators did) to listen at length to the charges levied against The System. He would apparently accept the validity of those charges, would express concern about the capability for control, and would promise to "do something". And he followed through on that promise, although not in the way we hoped.

He directed development of an "alternative" program, "Education for the People", which turned out to be no alternative, only a slicker version of the PPBS, with a new name. When this deception was exposed, he called for another hearing (see "Buggy Whips", Ch. 75, for a report of that hearing), invited leaders of the resistance to Asilomar for a "retreat", to reach "consensus", and continued to legislate elements of The System, as though nothing of any importance had taken place.

By examining one cell of the aquarian network, the truth about its "voluntarism" can be extrapolated.

While most Americans were totally mobilized toward winning world war 2, the agents of change in this subculture were working at fever pitch to win their silent war "in advance of perceptible hostilities". That silent war had been engaged for more than half a century at that time, but never officially declared.

By the time of Pearl Harbor, at least four departments of the executive office had become beachheads for the revolutionaries.

The Department of Agriculture had been penetrated during world war 1, and agents there had served as an advance guard to this revolution. It was in Agriculture's Bureau of Economics near the end of world war 2 that the professional staff of the Division of Program Surveys sought to establish "a new kind of survey research facility". (Was one of that "staff" the official from that Bureau who met with Dr William Wirt in 1933, at the home of Alice Barrows, and discussed the "New American Revolution"? See Ch. 38).

Active support for that research facility was found at the University of Michigan, and that was the beginning of the Institute for Social Research.

In the summer of 1946, a "small cadre" (note the military term) of those "professionals" from Agriculture brought life to a "Survey Research Center" at the University, and that was the nexus of one filament in the web of the aquarian conspiracy.

That "small cadre" formed the core which became the Institute for Social Research (ISR), one of many similar groups which comprise this subsurface network. The others used identic protoplasmic extensions of influence, until this subculture became "The Aquarian Conspiracy", as described in Ferguson's book.

Because ISR, itself, provided the information we are about to present, and because it is exemplary, it is selected as representative. Following is a reprise of some of the information in the last chapter, to put it in context:

\* In 1945, Kurt Lewin (a pioneer 'social scientist') had established a Research Center for Group Dynamics (RCCGD) at Massachusetts' Institute of Technology. After Lewin's death in 1947, RCCGD and the Survey Research Center (SRC) at Michigan U. joined forces, forming the Institute for Social Research (ISR).

\* In 1962, ISR spearheaded an Inter-University Consortium for Political Research (I-UCPR), involving 145 other Universities.

\* In 1964, ISR expanded, opening a Center for Research on Utilization of Scientific Knowledge (CRUSK). CRUSK's major thrust is 'education'. It has done extensive research in the "socialization" of children, and the processes of knowledge retrieval, transmission and application. It has done the same as regards teachers, parents, and other authority figures in a child's life. It was at CRUSK that the meaning of "basic education" was redefined to cover the early inclusion of "social science knowledge" in the school curriculum.

\* In 1970, a fourth branch was opened, the Center for Political Studies (CPS). In 1971, with a grant from the National Science Foundation, which was targeted for support of ISR activities "on a sustaining basis". The Institute confidently entered its second 25 years. Its now huge "professional staff" found themselves leading "a national resource for social science research".

It isn't possible to explore here the full scope of the activities of ISR and its satellites. They range over the whole gamut of the socio-economic/political spectrum. At ISR the most sophisticated methods to "survey" all kinds of people, organizations, activities, and conditions have been devised.

Considering this capability, one is reminded of a school superintendent who scoffed at a suggestion that parents might object to the prying necessary to implement the newly-exposed management system installed in the public schools. He said, "Some parents may decline to answer some questions. What they leave blank, we will get." Was he thinking of ISR and its years of collecting and storing information?

Each department of this Institute has its own functions. ISR, itself, concentrates on training staff, providing instructors, teaching, consultation, and devising methodology and procedures. In 1965, ISR enlarged its headquarters, and added still more research facilities. By 1971, it was gearing up to take on systematic management and data documenting.

SRC is directed at the study of all kinds of behavior - human, interpersonal, organizational, political, social, (including environmental factors), and urban and regional problems.

CPS - the Center for Political Studies - was only a year old in 1971, but had inherited the massive files from the Inter-University Consortium and from ISR, dating back to 1948. These files included comprehensive studies of politics and political bodies, both here and abroad.

Anyone who can believe that this thirst for 'information' is an end in itself, simply hasn't done his homework. Once such facts are accumulated, they will be used. Any of the elements in them can be manipulated systematically, to bring about 'change', and 'change' (remember) is what the aquarian conspiracy is all about.

Research such as is conducted at ISR not only is preparatory to 'change', but by involving, as it does, uncounted students in the process, it creates willing collaborators. Multiply the students involved at

Michigan University, by those reached at other universities, and the dynamics of this subculture become apparent.

THIS IS A PROCESS WHICH MUST BE SHORTCIRCUITED, TO END THIS REVOLUTION.

Addenda:

education = indoctrination

information = data

REMEMBER: "change" = NIEO.

Recommended Reading:

"The Aquarian Conspiracy", Marilyn Ferguson J.P.Tarcher Publ., 1980

"A Quarter Century of Social Research", ISR - Michigan University, 1971

"Foundations - their Power and Influence" - Rene Wormser Devin Adair, 1958

House Report #1439, (Examination of the Charges of Dr William Wirt) 1934

"Who Will Survive?", J. L. Moreno (Cited in California Senate Report on Education, 1958 Budget Session)

SUFFER, LITTLE CHILDREN - 91 - Human Rights

With all the talk about human rights these days, there are some human rights never mentioned.

Certainly a basic human right is that of children to remain innocent in their formative years, protected from the harsh realities they must one day face when time, growth and nature have prepared them for life. (If anyone is prepared for life in today's world!)

By what logic may children be forced to meet sexuality before puberty in compulsory classrooms? By what logic may the human rights of parents to decide when their own children are ready for induction into adulthood, be ignored?

America's children have been weaned by the government schools from the Christian/Hebrew standards of morality and responsibility, and redirected into humanistic life styles, with results clearly identifiable today.

Increasingly, those who, by nature or by law, are responsible for the well-being of these little ones, have been persuaded (or misguided) into moving that responsibility onto shoulders too small and weak to carry it.

Letting children determine their own path encourages them to follow that of least resistance. Passing value judgement to them, before they have an opportunity to learn consequences, can "make mental cripples or moral misfits of them for life" (Ref. the late, great California State Senator Nelson Dilworth).

The issue of premature exposure of children to raw sex in the classroom was raised in the late 50s, because, it was said, there was increased sexual activity in the young in recent years. Ignored, the history of "sex education", which was begun in earnest in the government schools half a dozen years earlier, stimulating that increased activity. Ignored, official findings then, which declared "horrifying" the material on sex provided as "guides" for teachers of grammar school children. Ignored, inherent dangers in stimulation of sexual impulses, by such material given to children not mature enough to know that sex is more than clinical knowledge of parts of the body or a source for an instant "high".

Ignored, the fact that many of these children had been taught for years that there is no biblical right and wrong, only "situation ethics", where wrong is sometimes right, and vice versa, depending on circumstances. Ignored that, from infancy, many of these children have been given easy gratification of their wants by parents who learned by the book - Dr Spock's book.

So-called "family life education" was rationalized in the 60s on the premise that our youth were casting off the inhibitions of a horse-and-buggy age; they were maturing earlier; sexuality was "meaningful" to them; they needed to know the "facts of life", which reluctant parents were not providing. The results of this thinking, put into action, have darkened countless young lives, caused many to end their own, and spread a plague among generations of young Americans.

Pregnant girls, still young enough to be playing with dolls, seeking abortions; increased distribution of pornography; increased rape and unnatural sex; increased venereal disease; increased use by ever younger children of illegal drugs as escape routes; increased disaffection, and even suicide, among children. These are some of the fruits of this evil plant.

The most foul denial of the right of a child to be a child, lies in the recruitment of them as objects of sexual molestation by adults, and/or filming of that abuse for profit. How close to that, though, is the denial

of a childhood free from the abnormal thoughts which follow exposure to premature discussions of sexuality?

There has never been a more obvious need for the people of this nation to put away their differences, and join in a mighty crusade to put a halt to this genocide of decency; this negation of the most basic of all human rights; this amoral denial of the right of children to be protected from problems which have no relativity to their age and competence.

Legislators, who readily find ways to control law-abiding citizens in their daily lives, are unable to come up with controls for this most pernicious criminality.

Use of the Bill of Rights, and, specifically the right of free expression, to protect the perpetrators of these crimes against nature, is a travesty of justice.



SUFFER, LITTLE CHILDREN - 92 - Sex  
and the SINGLE Goal

Let's just agree, up front, that sex can be beautiful. With the right person, in the right place, at the right time, it can be the closest thing to heaven this troubled world can offer.

But it can also be as ugly as sin.

Ever since Eve, licentiousness has been the shadowed side of sex, never respectable. Prostitution, said to be the oldest profession, never an honorable one. Pornography and prurience, always outside the pale of accepted society.

Not today.

Today, when any move is made to protect society from rampant evil, the cry goes up, "You can't legislate morality!" Of course not. But immorality can be, should be, and always has been, confined and circumscribed by the operation of natural law. Only in Sodom and Gomorrhah, and the last days of the Roman Empire, has immorality been flaunted as it is today.

Disobedience to the natural law of moral conduct carries with it a natural penalty. That penalty may take the form of illegitimacies, venereal disease, a burden of guilt, or an accelerated tolerance for depravity, or any or all of the other evils so visible and prevalent today.

Our permissive society has many roots, not the least of which grows in the soil provided by the introduction of raw sex into the classrooms of the government schools. How and why sex "education" was brought into the schools of America, is important to any effort by decent citizens to guard the minds of innocent children from the inevitable result of premature exposure to debauched promotion of sex as a basic study in the schools.

A short history of the continuing efforts to embed "sex-ed" in the schools is essential in attempting to protect the children from the effects of premature exposure today.

In 1980, Californians once more found themselves faced with the perennial problem raised by the sexologists. Citizens in the rest of the States found this latest foray surfacing in their schools, too. This was to be expected, for it was supported by the U.S. Office of Education (USOE), and thus was a national program. When California is loaned to the federals as a pilot for innovative programs, it is usually only a matter of time until the rest of the States are drawn into the federal orbit.

We have bared the root of this problem before, in another context, but it bears repeating. Those who do not know these facts should study them carefully.

As an apparent result of the American Library Report on education, in 1932 the National Education Association created an ex-officio organization, the Educational Policies Commission (EPC), for the purpose of changing the Goals for American education. The probability is that the real impetus was the Rockefeller General Education Board, which by that time was already well into setting the stage for those Goals.

Throughout the 30s, the EPC issued a number of "position papers" on the function and operation of education, and, in 1944, prepared a volume of extreme importance, titled "Education for ALL American Youth" (emp. in original).

The EPC assumed full responsibility for this document, while giving credit to the individuals who participated in its production. It "went

through many careful revisions", so it must be accepted that the final version says what it was meant to say. The widest possible distribution was obtained for it among teachers and administrators. It went through at least three editions in book form, and was then condensed, and put out in pamphlet form (the same strategy we have outlined in "Goals for Americans"). Obviously, this was something of importance.

This highly promoted document told, in fictional format, and as though it were fait accompli, how the Planners would solve all the problems - not just of youth - but of two imaginary communities, a village and a city, through involving the citizens in cooperation for the Goals of the Planners. (This is "participatory democracy" - unheard of publicly until 20 years later!)

The tale this book tells is an outline for combining federal programs for health, education and welfare under one giant bureau; for head start programs; for getting preschoolers into the system; for teacher participation in curriculum decisions; for "federal funds without federal control"; for youth services through a "poverty program"; for removal of local control of matters political and educational, "without seeming to do so"; and many more in the same genre.

Presenting the "either-or" concept of one highly undesirable program against one less obnoxious (a continuing tactic of these revolutionaries), this volume is a blueprint for the participation of "education" in promotion of the Planned Society, though pains were taken several times in the text to deny that this was so (just as was done in the Hoover "Recent Trends" text). The proof of INTENT lies in the fact that, in the intervening years, the programs so carefully laid out by the EPC in 1944 have been implemented, one by one - as was also the case in the Hoover Report.

And one of those programs was "family life education" ("sex-ed").

"Sex-ed" entered California's schools by way of Chico High, out of Chico State College, in 1946. This was localized, and based only on "supplemental" texts. Neither the local school board, nor the State Board had approved either the course or the materials. The course caused such a furor among parents and other caring citizens, that the matter was taken under advisement by the County Grand Jury.

After studying the materials for the course, the Grand Jury found that it was "not educational ... but, rather, in many respects (was) immoral". They declared it "inconceivable ... that any modern educator would even contemplate the use of the books ... for children of high school age".

The State Senate FactFinding Committee on Education followed up on the findings of the Grand Jury, and they also found much of the material unfit for high school students.

Now, here's the mind boggler. The material that was used in that high school course is almost indistinguishable from that prepared for kindergarten and preschool in the infamous Teachers' Guide, which received public censure when Wilson Riles, then-superintendent of California Education, tried to place it statewide in the "lower schools" in that State.

Despite the furor those Guides caused (or maybe because of it), a very important point was never raised. That point is the question of whether either of these incidents had larger implications. We raise that point now. When textbook publishers print material, it is not economically feasible to run just a few copies. How many of the "resource" documents were printed and distributed throughout the country? Were those programs used in other districts in the country, but not detected?

The arguments the educationists and sexologists use to promote "sex

education" in the schools, are specious. The rise in sexual delinquency among our young people has paralleled two promotions of the educational establishment, begun more than 30 years before. The first was "situation ethics" - the humanist concept that nothing, by its nature, is good or bad, right or wrong. The other is "sex education", which takes the filth out of the gutter, and gives it the respectability of the schools.

Can it be believed that the 'lost generation' of the 1960s - the flower children, the drug culture, the various other 'escapes' young people essayed in "religion", cults and communes, the amorality, rejection of values of all kinds - was unrelated to the programs given in the schools? Until the 60s, educationists were blaming the parents for the problems children were having. There was no way the diverse family cultures could all lead to the general disaster which that generation experienced. There was only one central source.

In the late 50s, another attempt to insert sex-ed in California's schools was found in the grade schools in California, in the form of a "comic book" which used two dogs named Blacky and Whitey, to demonstrate intercourse and miscegenation. It wasn't 'comic' at all, and parents were incensed.

In 1958, the California State Legislature formed a Citizens' Advisory Committee to look into the admitted failure of the public schools to perform their designated responsibilities in teaching fundamentals. (Yes, it was admitted way back then that the schools were failing in their supposed duties!) Heavily weighted with educationists, the Committee reported mainly on matters dear to the heart of teachers and administrators - class size, duties, salaries, etc. However, there was a Minority Report included, which responded to the public concern, especially about sex-ed.

So what happened? A limited number of the official Reports, (which included the Minority Report) was printed. The Chairman of the Committee then toured the State, attending any group meeting which would sponsor him, and distributed gratis innumerable copies of a privately printed copy of the majority findings - with no mention that the findings in the Minority Report contained a denunciation of the sex-ed classes - or even that there WAS a Minority Report. The Minority had expressed themselves as "horrified" at the content in those classes, and denounced the concept as "not the function of the public schools". And that was in 1958 - that long ago!

That 1958 Guide continued in use through the 60s, causing sporadic parental resistance, as new waves of children were brought into the schools, and new parents were faced with the "sex-ed" program.

In 1980, another, even more "horrifying" Guide was brought on line.

Raising again the hoary specter of VD, pregnant teenagers, and "sexually active children", the California Department of Education developed a series of "workshops" for teachers and administrators of the government schools, to acquaint them with the latest techniques in "Education for Human Sexuality" (subtitled "A Resource Book and Instructional Guide to Sex Education for Kindergarten through Grade Twelve").

It is clear that there was an intent to avoid the controversies which roared out of control in the 50s and 60s over the so-called "family life" programs, by the manner in which this Guide was promoted. There were no public hearings this time - no publicity.

The State Board of Education wasn't asked to "approve" this program. Had it not been for an alert, concerned professor at Humboldt State College, whose indignation about the Guide caused cancellation of the Humboldt Workshop, the ruse might have succeeded. When Professor Jacquelyn Kasun blew the cover, she accused State officials of trying to slip this

*\* John Stosmer points out that the term (minority) plays into the hand of our controllers. VII - 27. Call it Dissenting Report.*

radical interference with parental authority into the schools as a "teaching tool".

Professor Kasun wasn't one of the chosen recipients of the Guide, and was refused a copy when she asked for it. She said that the copy she finally acquired was "bootlegged" into her house in a brown paper bag.

Others, including the Catholic Conference Director, found it equally difficult to obtain. The Department of Education even refused to disclose the names of those who had prepared the California Guide.

Stamped in the top margin of each and every page of the copy I obtained, in bold, black letters, is the demand: "DRAFT - DO NOT REPRODUCE". Clearly, this is a veiled threat to any citizen who might wish to fill the void left by official reluctance to permit operation of the Brown Act, which states, in so many words that "the people of this State do not give their public servants the right to decide what is good for them to know, and what is not; that the people retain control over the agencies which serve them". Or, perhaps it is a threat to any who might make copies and hand them out so that people could see for themselves what the schools are doing to their kids (which had been done with a previous "guide").

Like the infamous programs of the 50s and 60s, this Guide is a thinly disguised attempt to establish sexuality as a constant in the child-minds entrusted to the gentle ministrations of these "public servants".

Emplanting constant thoughts of sex in a target group or individual, is a key factor in psychopolitics - an integral objective toward the goal of controlling the minds and lives of the "human resources" needed to create a functioning new world order.

As Erica Carle pointed out in one of her excellent studies of educational aberrations (which educationists label 'innovations':

"Sex is the ultimate weapon in people-taming, and people control. When sex can be established as a constant in the mind...as the dominant idea... the mind can be incapacitated, the emotions destroyed, personal identity, individuality, family life, and maternal and paternal feelings, eroded. ALL ELSE can be forgotten or regarded as unimportant, when the mind is captured by the dominant idea of sex."

To force thoughts of sexuality on three year olds, as is done in "Education for Human Sexuality", is an offense against nature, in a class with child molestation. To continually, throughout the primary school years, and throughout the gamut of classes, emphasize the sexual part of human nature, is an invitation to tragedy.

To do this without "moralizing", as is done in these programs, is obscene.

Finally, after the entire state of California had been put in turmoil over this program, the headline read "SEX GUIDE MEETINGS CANCELLED". The story reported that Wilson Riles, duly elected chief school officer for California, "has all the opinions he needs on his controversial sex education Guide".

Parents of children age three and up can now relax. Right? Wrong.

There has been no report on how many of these pornographic Guides were published at taxpayer expense, but at least 1600 of them were put in the hands of those who attended the 10 workshops held before public attention focussed on this latest "planning tool", and caused cancellation of the teacher training sessions.

Riles said the Guide would be revised, and republished, but he didn't suggest a recall of those already distributed, nor discard of the remainder

of the original printing.

There is unquestionably an abundance of the Draft Guide still existing, and nothing to stop the use of them, if a teacher decides to go it alone.

In addition to the publicized content, the Guide is replete with pages of reference material, which, from the titles, appears to offer extension of the subject matter. More than that, NOT ONE of those who received these Guides at the Workshops was impelled by conscience to alert the parents of their charges as to what was in store for them! (Just as was the case in the Moscow School incident.) Had it not been for Professor Kasun, the program would have been institutionalized before any parents were aware of it.

If that isn't disturbing enough, there are teachers already applying the concepts offered in this Guide. That is not an accusation. It is an echo of the consultant who coordinated development of the Draft. She said there was nothing in the Guide which she hadn't been using during the 10 years she had taught sex in the classroom!

There is no protection in the laws of California from such perversion of the educational process, since this is not a "mandated" program, and only mandated programs are subject to scrutiny. This was a "resource", and, as such, was exempt from control. All who are concerned about their children would be well advised to see if this holds true for their schools, as well. An immediate correction should be made, to require that ANY material used in the public schools must meet a given standard.

The sexologists have achieved the objective sought, by presenting "workshops" to introduce the new "resource book and instructional guide". That objective was to alert cooperators in the system, to refined strategies for implementing sex-ed.

Sex education is now embedded in the curriculum of the government schools, despite vehement objections from the parents, and supportive evidence for the parental position from scholars, psychologists, and even psychiatrists, that premature exposure to sex facts is harmful to the children. Despite the empiric evidence that delinquencies rise following such exposure, educationists continue to promote sex-ed. Ignored, the indisputable fact that sex-ed predates the rising curve of promiscuity.

If there is to be any hope of saving the children, any attempt to do so must take into account the methods used to create this unbelievable situation, for its influence has now spread even further. Raw sex has permeated movies and television to an almost total extent. Our youth, exposed to such destructive information in the schools, have now grown to adulthood, and are spreading what they learned as intended.

It will take legislative denial of sex education, to remove this pernicious program, which is an invitation to promiscuity, licentiousness, hedonism - and worse - from the government schools. That is a priority matter.

While parents who remove their children from the public schools are to be commended for trying to protect their own, they must remember that their children, as adults, are going to have to live in a world in which the majority will have been subjected to this insidious penetration of their minds as children - and how will either those so abused, or those protected from abuse, cope with that?

SUFFER, LITTLE CHILDREN - 93 - Inducing Sexual Lust

"The first thing to be degraded in (conquering) any nation is the state of man, himself. Nations which have high ethical tones are difficult to conquer. Their loyalties are hard to shake ... their spiritual integrity cannot be violated..."

Lavrenti Beria  
"Psychopolitics"  
Lenin School, 1934

In reporting on the revelation of the Teachers' Guide intended for use in the government schools of California, we pointed out that a key factor in psychopolitics is establishment of sexuality as a constant mental stimulus. Presenting explicit sex from the authoritative position of the government schools, particularly in the absence of any moral value, is guaranteed to direct the child-mind into destructive channels.

Psychopolitics, by definition as well as substantive evidence, is now an integral factor in every phase of American life. Its use is a necessary adjunct toward the goal of universal control over all the world's people and resources.

Conquest of the United States of America would be a practical impossibility without it.

Announcement that the California Sex Guide had been 'shelved' offered no reason for optimism. The official release included the information that responsibility for sex "education" was being returned to the local districts. However, while the Guide was thus not "mandated", sex "education" was, so the weary battle by the parents returned to the local Board rooms, and it promised to be a losing one. WHO do you think bought all those copies of Riles' "best seller"?

And so the battle for the minds of America's children continued.

Without in the least minimizing the vital need for resistance to pornography in the classrooms, it should be pointed out that there is a wide, supportive network advancing the same cause of keeping sexuality as a constant in the mind, which is not limited to children. It insidiously attacks ALL ages. One of its effects is to develop acceptance in adults of the pernicious attack on the children. Another is to make adults vulnerable to the seduction of the change agents.

Please keep in mind that psychopolitics requires degradation as a prerequisite for control. The evidence of this 'art and science' being actively promoted and used is extensive. One such piece of evidence was ABSCAM. Application of psychopolitical strategies upon elected officials is continually evidenced. These are men who have to ask the people for the right to hold office. What kind of impetus would cause so many of these to act thus, when they know it means their jobs?

The use of psychopolitics on the general public is not as easy to track as is its use in the schools and on public officials. That makes it all the more threatening. In the interest of more general recognition of the personal jeopardy this holds for all Americans, let us mention some of the evidence first.

It is common knowledge that there are more marriages breaking up today than there are couples getting married. The most shocking stat about this is that the increase is greatest in the age group which had weathered the 'hard' years of adjusting to each other and to wedded bliss, raising families, getting ahead financially, and supposedly reaching the 'golden years'. This is a recent phenomenon.

The apparent amorality of 'religious' figures, as evidenced in the scandalous affairs which dominated the 'news' in 1988 is another facet of psychopolitics at work.

Other indicators of successful degradation of the American character abound. They include crime, particularly the types of crime (rape, child abuse, serial murders), and the kind of people who are involved. Include, too, drug and alcohol abuse, which is at an all time high. Look around you, and you won't have to look far, to recognize lowered standards in your own circle of family or friends.

You won't have to look far, either, to find the source of the stimuli.

Do you leave the room, when the commercials come on your radio or TV? If you do, you aren't receiving some of the most effective 'messages' psychopolitics puts out.

If you allow your children to sit for hours in front of the tube, you are allowing reenforcement of the school sex-ed program, and even additional stimuli. If you choose their programs, and ignore the commercials, they are still at risk.

If you watch TV at all, you must be aware of the kind of adult fare which is available. People who sit for hours, drinking beer as they watch sports events or what passes for "entertainment" on the 'tube' place themselves in serious jeopardy. Notice how many of the cable movies are rated X or R. Increasingly, TV's "interview" shows are featuring the sleasiest kinds of 'guests', with the wierdest perversions imaginable. And the workshops for aspiring comics are straight out of Minsky's burlesque, which no self-respecting citizen would attend 50 years ago.

Radio talk shows are classic, in the ways they bring in sexual stimuli. For years, these have been used to elicit reaction from listeners on any given subject. In recent years they seem to have changed their role. They seem to frequently 'test' their callers on the extent to which they are absorbing the sexual stimulation, and the New Morality.

"Doctors" have been increasingly used as guests, and they most frequently speak on topics with some sexual connotation. As the battle for the mind heats up, doctors and psychologists have even been replacing the hosts, and, regardless of their specialty, the topics they bring up are usually either centered on sexual problems, some related to physical abnormality, or drift into such subjects in the course of the program. Psychiatrists and psychologists abound on radio, and encourage open discussion of matters better handled in a private session. Live-in lovers and extra-marital relations are accepted as a matter of course.

How many listeners are overtly affected by this steady stimulation of amorality? How strong must spiritual integrity be, to withstand it? How many children have radios beside their beds, and tune in to this planned erosion of public morals and private morality, when their parents think they are asleep? Do they get validation of the teaching they receive in school on the public airwaves? How many parents who listen will find their own standards watered down by the seductive voices of the psychopolitical corps carrying out their assigned assault on family, morals, values and integrity? How many of those parents will be unable to give moral or spiritual support to their children, because of this undermining of their own beliefs and principles?

While pondering these unanswerable questions, ponder, too, this final statement from Beria's textbook on psychopolitics.

"The end throughly justifies the means. The degradation of populaces is less inhuman than their destruction by atomic fission. For an animal who lives only once, any life is sweeter than death."

SUFFER, LITTLE CHILDREN - 94 - The New Social "Order"

Steadily, stealthily, with a minimum of public debate, and only sporadic resistance, our locally-controlled public schools have been transformed into a federally controlled monopoly. This transformation can not be glibly passed off as just another encroachment of the federal bureaucracy, like wool growers subsidies, or even an invasion of federal inspectors-general overseeing violations of the IRS.

This is a matter which not only affects the individual children of each and every parent in this country, it impacts the total future of the nation - and by extension, the world.

Capture of the public schools is the most critical engagement of the quiet revolution. It dwarfs every other theater of revolutionary assault by the very nature of its impact.

That this subversion of the educational process has managed to survive both its proponents AND opponents speaks to the invincibility of the planning which went into the strategies developed to achieve this objective.

Perhaps ignoring continuing exposures of its portent by opponents such as we have discussed, is understandable. There was no previous yardstick by which to measure such perfidy, and no way to validate the postulated results.

But it is more difficult to accept the way statements by participants in this revolution were passed over, as though they never occurred:

- \* The Occasional Papers of the GEB were explicit, and public property;
- \* The arguments for a national education system in the 20s;
- \* The voluminous report of the prestigious American Library Association clearly outlined the road ahead;
- \* Close on the heels of that Call was the address to organized educationists by George S. Counts, a prominent educator and an involved collaborator, in which he posed the question "DARE the Schools Build a New Social Order?"
- \* The Educational Policies Commission and its recommendations;
- \* The Call for "A New Educational Agency for the Future" in the 60s;
- \* NDEA '59 and ESEA '65 and their call for "innovation";

How could these have been given so little credence, when they came from "the horses' mouth"?

There were so many true teachers then. So many local school Boards. So many legislators elected by constituents who held them accountable. So many news outlets still supportive of the status quo. So many citizens who still practiced the old virtues, who still felt a thrill when the flag went by, who held the principles on which this nation was founded inviolate.

How could such radicalism as was admittedly of the essence of this revolution not call forth an immediate and decisive reaction? That is still the unanswered question.

All of the schemes named by both proponents and opponents have become accomplished fact. If the captured educational territory is permitted to continue on its present course, the future is no longer debatable.

It is only realistic to ask if the captured enclaves of the schools can



be disestablished. It is even more realistic to assert that they MUST be. The alternative is too horrendous to contemplate.

Already, the results of all these years of quiet revolution in our educational programs and methods can be tallied. From border to border and coast to coast children from every sector of our society evidence the devastating results of this despicable assault. Bewildered, unprepared to meet the responsibilities of maturity, divested of any moral principles, ignorant of the past, and afraid of the future, the youth who have been the innocent victims resort to drugs, delinquency, depravity, and disobedience to any code of law. Reckless abandonment of any moral, ethical or even practical restraint marks the paths of the future citizens of this country. Most of them do not know why they do the things they do. Many of them simply do not care. Like the lemmings, they are rushing to their destruction blindly - and taking with them the hopes and dreams for the future of civilization.

The canard that "the parents are to blame!" stands convicted at the bar of common sense. It IS education that shapes the common mind. These young people spring from all walks of life, and the public schools are the only common denominator they share - except the despair which is impelling so many to opt out of a life with which they cannot cope.

There was order in this country, before these interventions began. Today there is only discord, dissension and despair.

**Excerpts from an address by  
The Hon. Nelson S. Dilworth,  
late, great California State Senator,  
delivered 16 August, 1957  
to the Commonwealth Club at San Francisco.**

Has not your heart thrilled at the sight of a herd of cattle gathering in a circle around their calves when a band of strange dogs cross their pasture. Do we as human beings care less for our children than dumb cattle for their young?

Books and teachers who are purveyors of strange ideologies are enemies indeed who would cripple our children in mind and pervert their honor and understanding.

Who will deny that we should give of our best to our youth, our sons and daughters who have sprung from our loins? Yes, the best of our lives, the best of our means, the best of our freedoms, the best of our ideals, the best of our literature. There are so many good books, so many that no one has numbered them, biography, history, science, pure romance, books of morality, truth, justice and patriotism, just as the law tends, need we spend public funds for the inferior, the corrupt or the degrading books of the failures along the way of life?

Perhaps you say selection yes, but not removal. This question of removal is a difficult one. Americans have been too trusting. Believing that others acted on the same high ideals as their own, teachers, administrators and board members have been slow to criticize, reluctant to condemn. Those who would corrupt our youth, have presumed on the natural tolerance of Americans. They have hidden their vicious wares under the cloak of an academic freedom designed for mature adults. The result has been that materials derogatory of our American history and achievements and laudatory of totalitarian government have found their way into schools for our youth.

... would you hesitate to throw a rotten apple out of a box of good sound apples prepared for distribution to our young people? Is that censorship? Would you give the rotten apple to a child? It only takes one book to suggest loose standards and improper conduct. It only takes one false book to raise doubts in the minds of inquiring youth with their natural and proper curiosity about this big world around them.

Is it censorship if, in selecting books for our school children's desks and libraries, that our school board members insist on books that "impress on the minds of the pupils the principles of morality"? If that be censorship let's have more of it. Is it censorship for board members to insist on the selection of books that will encourage truth and justice? Is it censorship to insist on the selection of books that teach patriotism? I warn you that patriotism, like everything else, has to be taught and to be taught effectively it has to permeate all our books and it has to be lived sincerely by both parent and teacher.

Children can be made mental cripples and moral misfits for life by communist ideology in the classroom. To face life with perverted ideas on economics and political institutions cripples a youth more destructively than automobile collisions or polio diseases.

There can be no enduring Republic in America operating in constitutional liberty to express the will of the people unless we have citizens and leaders who are devoted to the Republic and who have been well taught in their youth all the methods and necessary means of preserving freedom.

# section VIII

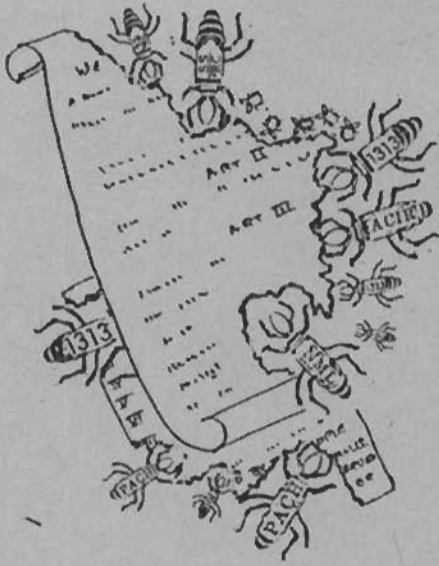

## The Authoritarian State

ch:	pa:
95 Police State America	VIII - 1
96 What You Don't Know	VIII - 4
97 The Plan to Take Over America	VIII - 6
98 The Information Gap	VIII - 8
99 The National Police Force	VIII - 11
100 Law Enforcement "Assistance"	VIII - 13
101 "Nobly Save or Meanly Lose"	VIII - 16
102 Divide and Conquer	VIII - 18
103 Strategic Weapons and Tactics	VIII - 22
104 The Patterns of Disorder	VIII - 24
105 Mutual Aid	VIII - 26
106 They're After Your County Clerk!	VIII - 29
107 An Unparalleled Disaster	VIII - 31

To place the development of the Police State in this country in perspective, it is of some importance that there be not only basic information on the way 'law' operated in this country prior to the interventions of The Planners, but of the way other countries have had tyranny introduced. In other chapters in this book we have addressed the matter of overt takeover of formerly sovereign countries by external force. But some countries succumbed to internal, seemingly democratic, forces, such as are being witnessed today in the United States.

To aid in obtaining reliable facts about the steps which led to tyranny elsewhere, short of spending days in a public library going through microfiches of old newspapers and magazines there is nothing to compare with old annual almanacs, which contain highlights of actual events from the preceding year. These almanacs are getting scarce, but copies can still be found in second hand book stores, and occasionally at rummage or garage sales or flea markets. They contain a wealth of factual information.

"Used Book" stores (especially off the beaten path ones) are a gold mine of out-of-print books. Many of the references here were found on dusty shelves in such places. Old textbooks, actually used in the schools before the revisionists began to rewrite history, are also a good source of information. We selected such a text, 1934 vintage, which was used in classes in California's Fresno State College prior to revision, to illustrate our premise in this chapter. Because it is a fascinating example of advocacy, as well as an accurate account of "New Governments in Europe" (its title), the text we chose for our purpose here is a classic example of the use of true fact in creating an erroneous belief.

"New Governments in Europe" was published by The Foreign Policy Association, and featured the writing of Vera Micheles Dean. Since both the publisher and the scribe were supporters of the 'one world' thesis (the theme of the text) understandably, it fosters student acceptance of that concept. Despite that shortcoming, this text offers demonstrably accurate reporting of then-emerging patterns of governments in Europe in such a concise and reasonably accurate manner that it is an acceptable frame for a reference point.

For our purpose, we selected the chapter on Germany in "New Governments in Europe" because the legal government there (before Hitler) strongly resembled our own government, and because the steps taken there toward the 'emergence' of the police state seem to have been a template for the steps taken in recent years in America toward that end.

This textbook states that:

"The Weimar Constitution still (in 1934) forms the legal basis of the German State. It (the Constitution) survives, however, as an empty shell."

So, in America. The Constitution still forms the legal base for the government of this country, but it is honored more in the breach than in the observance.

The textbook goes on to enumerate the incursions on the Weimar Constitution which produced that "empty shell" in Germany:

"...the chancellorship and the Presidency have been merged into a single omnipotent office;

"...no division (remains) between executive, legislative and judicial powers...;

"...individual liberties have largely disappeared...;

"...the federal structure has been swept away;

"...Germany has become an authoritarian, unified state."

And in America?

\* The Office of Management and Budget (OMB) is now the center of government, and the 'President' is but a front man for the invisible government.

\* The Constitutional division between the legislative, executive and judicial powers has been eroded. Today the lawmaking power is vested in all three: Congress has usurped presidential prerogatives; the President bypasses Congress; and the Supreme Court consists of ideologues whose personal philosophy rules over Constitutional mandates.

\* Individual liberties have all but vanished, and those which remain are in constant jeopardy.

\* The federal structure has been swept away in a flood of regional arrangements.

America is now an authoritarian, unified state.

The same steps which created the police state in Germany have also altered the essence of the lawful government here:

\* Ask not why your Congress and state legislators no longer do your bidding;

\* Ask not why the man sitting in the oval office can campaign on "Read my lips" and then, in office, repudiate his promise;

\* Ask not why the judiciary no longer determine Constitutional issues on their merit;

\* Ask not why candidates no longer speak of the issues which concern YOU.

NONE of these are relating their actions to the Constitution which governed this country so well for so long. All of the above are acting in relation to the altered state - a unified, authoritarian, administrative, non-responsive programmed governance.

Was Germany a "pilot project" to gain the needed experience, tactics and strategies for a successful coups in the United States of America?

It could have been. There is a clearly discernable history of the use of prototypes for exercises in subversion of this country. One in particular was the so-called "5-5-5 Project", which boldly claimed the experimental nature of its penetration of five states, five counties, and five cities in preparation for national implementation. This was one such incident which does not have to be presumed to be a pilot. Its perpetrators themselves proclaimed the fact. Another such incident (though this was not admitted) was the so-called "replacement" for the PPB System in California's education structure. There are many such examples which can be identified only because their content or later events demonstrate that they were "practice runs".

Preparations for Police State America were replete with incidents which demonstrate the fact of preplanning. Thus, in 1963, the Rice Lake (Wisconsin) Chronotype reported on a "war game" directed at farmers, who

might resist a planned 'government' assault on destruction of their capability to produce foodstuffs. Charging that elimination of small farms was a 'government' objective designed to cause food shortages, the paper printed pictures of the training of the National Guard in riot control, to quell an expected revolt by the farmers.

Members of the Combat Support Unit from the first battalion of the 128th Infantry Division of the National Guard were divided into typical 'red' and 'blue' training units. One 'team' was designated to represent the farmers, the other, the 'protectors of law and order'.

According to the article, the latter were "trained and psychologically conditioned to control, arrest, or even shoot some of the protesting farmers". Also mentioned was the assimilation of local sheriffs and police into the "exercise".

Long before that, in 1950, another necessary preparation for the planned military control of the country was conducted in a number of cities and towns, primarily in southern California. The Los Angeles Sun carried the story of one of these, which was thought to have been the first in the country, in Palm Springs. The article was headlined "A 'Mock' Military Government Takeover or Rehearsal for the Real Thing?"

This "exercise" was conducted by Army Military Reserve Units, which later "occupied" nine small cities around Los Angeles in July 1951. I was living in one of those small cities at the time, and I can remember the incident vividly. To quiet the citizen reaction, the local papers carried an official explanation that the maneuvers were necessary in case of an invasion by a foreign power. In Culver City, the press reported the explanation that they were preparations for use in some unidentified foreign country.

In all cases, substantially the same tactics were used. City Hall was "invaded", and the Mayor and councilmen were taken prisoner, forcibly removed from their offices, and jailed. Civilian activities were then taken over by the military.

The Sun reported that these maneuvers were not done under the stars and stripes, but under a blue flag similar to the United Nations emblem.

The article stated that the exercises were done under the authority of the newly passed Universal Military Training Act.

There is a continuing record of similar incursions against lawful conduct of government throughout the years. In July 1963, John Fitzgerald Kennedy issued the puzzling series of Executive Orders on "emergency planning", which created authority for specific instances such as these, covering every aspect of the political spectrum, even including a blanket authority, in case some unforeseen circumstance arose which was not covered.

Also in 1963, a massive "exercise" known as "Desert Strike" was conducted, and a later, expanded version was known as "Operation Water Mocassin".

In 1969, the Anaheim Bulletin carried a front page, headlined report on a 'secret' official plan to take over the cities, just as was done in the 50s pilot projects.

These acts against citizens and their duly elected officials were sporadic throughout the 50s and 60s, but became institutionalized with the passage of the "Safe Streets and Crime Control Act" of 1968, and creation of the "Law Enforcement Assistance Administration" (LEAA).

Only, under LEAA the activity took place in the government directives, reports and response within the agencies prepared to deliver Police State America.

At a political meeting in California in 1974, a delegate had asked for time to present information on the ongoing program for a "criminal justice system". He felt what was being done was of major importance, but that there hadn't been enough knowledge or concern about it. Word got around that he was going to speak on this subject, and some who would not otherwise have attended, went to hear him. Many who had followed the so-called Council on Criminal Justice since its inception, had serious reservations about the work it was doing, but not enough information was being reported about it to make a judgement.

Among those who went to that meeting to learn more about Criminal Justice, was a little lady from Hanford, California, who, in just a few short years had changed from a happy housewife and mother, to a dedicated, vocal opponent of regional governance. This metamorphosis had been occasioned by the appointment of Bernadine Smith to the King's County "Citizens Committee" for economic development, where she first became aware of the regionalist Plan.

Born with a strong aversion to halfway measures, and brought up in a tradition of love for God and country, Bernadine, as a wife and mother, had put her heart and energy into her family and home. The children successfully launched into their own lives, the home a picture of perfection, and with her devoted husband and partner in a successful business concurring, Bernadine turned to public service to absorb the energies no longer needed by her primary interests.

On the Citizens Committee, Bernadine Smith found herself unable to believe what was being proposed for her community. Determined to find out why people (herself included) didn't know what was going on, she wrote a State Senator, who had been in the news talking about this subject. His response confirmed her worst fears. That was the beginning of the rest of her life, as she searched for answers to the questions which flooded her mind.

Days and nights of poring over massive, technical and governmental documents; attempts to involve her neighbors and friends in her concerns; contacts with state and local officials; volunteering for work in her chosen political party. Based on what she saw 'happening' in her own community, as well as original research, Bernadine put her research findings into a study on regional governance. In that study, she documented Ronald Reagan's active participation in the forefront of regional planning, from his acceptance of appointment to the ACIR, to his active role in formation of the regional police.

Continuing concern had taken her to the aforementioned political meeting. There, she learned that Reagan was programmed to issue a proclamation accepting the 'recommendations' of his Commission for reforming the criminal justice system. She responded to an obvious need. She got a group together, and they demanded a meeting with Reagan. With the help of a brace of Senators, they forced that meeting.

As a result of that confrontation with lame-duck Governor Ronald Reagan, Bernadine Smith became 'controversial'\*.

While the meeting with the Governor was being arranged, additional information was uncovered which documented the fact that the Blue Ribbon Commission which Reagan had appointed had been subjected to a mind-control technique known as "Delphi", by which means the Members had been brought to accept by consensus almost all of the Standards and Goals already

programmed for inclusion in the planned "criminal justice system".

In the confrontation, Ronald Reagan claimed he did not know of the proclamation he was scheduled to make, which would approve the "plan to take over America" through a national police working jointly with the military. It was difficult then, and far more difficult now, to believe that Reagan actually did not know of the proclamation. The fact that he did nothing to nullify the results of the work of the Commission, even after being informed of the intent of the job being done, plus the fact that after being installed in the White House he extended The Plan nationally, speaks louder than his words.

As the facts emerged about the so-called 'Iran/Contra' disclosures, all America was stunned by Reagan's claims that he had no knowledge of what was going on within the National Security Council, which he headed, and which was manned by his hand-picked 'advisors'. Can it be that his professed innocence of knowledge is but another strategy in the game plan we are documenting?

If he has learned that what you don't know CAN hurt you - can, in truth, be mortally wounding - he evidences no recognition. The demonstrable record of development of this plan makes him culpable, as his part in it is liberally recorded in state documents produced under his leadership, and is now part of the record at the federal level.

Perhaps the most puzzling aspect of the California affair is that it did not result in the end of his dream of the White House. An heroic effort was made by the citizens who knew of this perfidy, to inform the public at large of its portent. UROC (United Republicans of California), the largest Republican volunteer group in the State denied Reagan their support in any future political plans he might have, well in advance of the national campaign. The public press chose to ignore both the United Republicans' Resolution, and the political implications.

Can Bernadine be faulted for her open rejection of his plea of ignorance of any scheme to implement the Criminal Justice Goals before he left office in Sacramento, when he made no effort to impose his great prestige in opposition to the Standards and Goals - even after he was informed of their import by the delegation she headed?

The attacks on this courageous patriot accused her of "nitpicking", while, in fact, it was her detractors who were guilty of indulging themselves in this childish substitute for meritorious argument. Lacking substance in their charges, her opponents resorted to "guilt by association", by including one of the finest constitutional writers in the country - Jo Hindman - in their slanderous attack on Bernadine, merely for reporting the facts about the meeting with Reagan!

Sincere Americans, including those who may have been misled into condemning Bernadine Smith because they didn't know the facts, should look carefully at the record before being judgemental. They, too, could learn that what you don't know CAN hurt! This holds true of ANY such attack, on anybody who attempts to show that there is room to question acts which have impact so demonstrably inimical to the best interests of this nation.

It is a national disaster, if charm and a winning smile are allowed to take precedence over the truth.

As one of Bernadine's detractors said in the heat of the battle, "It's hard enough to fight our enemies, let alone those who profess to be our friends."

We better be VERY sure who our friends are, before we fight at all! That goes in spades for our enemies.

#### Addendum:

"controversial" = anything or anyone who impedes or threatens to impede Establishment plans.



The revolutionary movement toward "a new world order" has advanced so far, now, that its achievements are becoming evident to the most 'apathetic' amongst us.

Depending, as it must, on a conditioned citizenry which will accept the most flagrant ridiculousities as 'normal', the revolution also depends on a careful nurturing of an illusory 'normalcy' by the news media. Obediently, the media suppresses or omits the reporting of any 'news' which might encourage recognition by the general public of the proliferating progress of the revolution.

At the same time, the media picks and chooses any of numerous situations, which have no relevance, to magnify and stress in their reports. The illusion of 'normalcy' is furthered, too, by saturation reporting of nonconsequential trivia, or by sensationalism, such as 'child abuse', sexual peccadillos, and mass murders, which, while of singular concern, do not compete with the destruction of a nation for newsworthiness.

So, when information about matters of substance which involve revolutionary action is offered by establishment sources, it should be approached guardedly, and examined carefully, to determine what purpose it serves.

This is the case with a number of columns which appeared under the byline of that master of diversion, Jack Anderson. Since his articles concerning the matter of 'criminal justice' began appearing just before the November, 1984, 'election', it could be thought that they were just a shot at the Reagan administration, to aid the challenger. To the initiate, aware of the Reagan record, this is ridiculous on its face. But to those citizens who are only beginning to recognize the real problems, their decision at the polls might well have been colored by the matters disclosed in Anderson's columns.

The columns in question had titles such as "A would-be dictator in Washington" and "Glorified air-raid wardens plan to take over America" and had direct relation to the confrontation California citizens had with Reagan, as a result of Bernadine Smith's attempt to derail The Plan for 'criminal justice' in California.

Anderson's columns had to do with the activities of one Louis Guiffrida, and a federal agency called "FEMA" (Federal Emergency Management Agency). His articles appeared to suggest that he considered he was dropping the equivalent of a nuclear bomb from his Washington Merry-go-round. The truth is that none of his facts add up to the impact of a 4th of July "lady's finger".

Anderson's information about the Federal Executive Orders (EOs) was made public by every noncontrolled news outlet in the country in the early 60s, when John Kennedy entered them in the Federal Register. The Establishment media considered this vital information 'non-news'. Anderson's expressed concern about a pending bill (the Defense Resources Act) which he quoted as being designed to "provide the Executive Branch with the authorities (sic) necessary to meet various conflict contingencies" is absurd on its face.

Just in case he is really unaware of the fact, when those EOs were entered in the Register, and not contravened by Congress, they assumed the force of law. As reported in this book, but it bears repeating, this situation arose from a 'law' promulgated by Herbert Hoover, when he was in the White House. Hoover caused an amendment to be attached to a bill being

considered by Congress, under which the Executive could enter an EO in the Register, and, if Congress did not nullify it within 30 days, it assumed the full force of any legislative act. Hoover called this "putting inertia on the side of change". And it has served the revolution well ever since.

As for FEMA, and its potential, it is no more concerning today than it was a decade and a half ago, when Don Bell broke the story of the training camp set up in California under the administration of then-Governor Ronald Reagan, which was created to prepare the framework, personnel and strategies for such an agency.

This writer did a series of articles on its content, back in 1976, which were widely distributed later in the form of a pamphlet titled "The Rim". We also wrote a number of columns on the methods used to control the groups commissioned to develop programs such as FEMA to assure that they didn't veer from the goal.\* To our knowledge, that is the only record of actual control of such groups which has been documented.

It is that kind of control which is now making a shambles of our laws and our lives, and succeeding in integrating these "flagrant ridiculousities" into a government which was intended to outlaw forever such oppressions as they contain.

Yes, Jack, and yes, America, there IS a plan to take over this country, and the operation known as FEMA is a vital part of it. But where was Jack Anderson, when defanging it would have been comparatively simple? For that matter why was it not reported before it became de facto, and in the first stages of operation?

Did Jack Anderson (or his puppetmasters) want the American people to 'fight back' at an identified peril, which they were to believe was only a proposal instead of an actual program in being? Were the citizens to spend their time and resources trying to "stop" this monstrosity, when it really needed excising, since it was already past 'stopping'?

Were the American people to waste their shot on a puffed-up National Guard General and imaginary 'air wardens', who, in truth, were but tools for those who really planned this operation? Were they to bombard Congress with letters opposing a bill which, to all intent and purpose, was already law?

Come awn, Jack! If you really want to drop a bomb, get your 'associates' to uncover the REAL story as to what and who is behind the "plan to take over America", so the American people can get at the real culprits, before it is too late.

Those "specific outrages" which you report FEMA has in store, such as "to suspend the Constitution and the Bill of Rights, effectively eliminate private property, abolish free enterprise, and generally clamp Americans in a "totalitarian vise", have been approved by every occupant of the White House since John Kennedy. Ronald Reagan was in the Governor's chair in California, while Louis Guiffrida began building this empire there, under the authority of the Law Enforcement Administration, and the Governor's Office.

The games you describe being played in and through the National Security Office and the Justice Department are a smokescreen, to divert attention from the substantive issue, which is, there is no one in Washington (or, indeed, in any branch of our government) with the backbone needed to blow the whistle on the shadow government which is responsible for the desecration this program represents.

In order to understand what is wrong with 'criminal justice', one must at least become familiar with the practices which were the operational body of law enforcement in the context of historic procedures. To be able to correct erroneous practices, an understanding of how law and order was effected under our lawful government is essential.

Today's practices in 'criminal justice' have been put in place incrementally, through a series of maneuvers which, seemingly unrelated, have yet altered the purpose of our legal system in subtle ways which are difficult to detect, until they are forcefully activated, at which point citizens may well find themselves caught up in a legal tangle all but insoluble.

Even a watchful citizenry may be forgiven for not recognizing a deliberate plan behind the alterations. Unless one has followed the machinations which have prepared the way for the radical changes in the system of "justice" now in place, one is unlikely to question the methods being used. Even so, many facets in the reconstructed system appear innocent, until one day they are brought on line, and their true nature is exposed.

There is less reason to excuse our elected officials for their blind acceptance of those alterations. They should have been standing guard, and were not.

In our chapters on regionalism and land use planning (LUP), we have pointed out some of the 'new' approaches to 'justice' as applied through Court decisions in those matters. Now your attention is directed to some of the important steps which have been taken to bring our judicial system in line with the "overlay government" which has all but destroyed the time honored, value-proven system provided in our Constitution, and/or through a century of painstaking construction of equitable application of justice.

Most of these changes have been brought about in less than a third of the time it took to build them, through the activities of the regional beachhead in the federal government - the Advisory Commission on Intergovernmental Relations (ACIR). Even if the ACIR had not provided a clear record of its involvement in these matters through its monumental Reports and advisories, its presence in them is affirmed by the neat interrelationship of each alteration with every other. There is no way that such steps supportive of the ACIR goal could just 'happen'. They HAD to be planned, and ACIR is the Congress-approved, self-proclaimed planning body for these matters.

The ACIR scheme for replacing elected representatives with appointed "experts" has already been discussed. So has elimination of the oath of office as a requirement for the duties of appointees. There was a time when every meeting involving public matters was opened in the presence of the flag, with the pledge of allegiance recited in unison by all in attendance. When these symbols of sovereignty first began to be eliminated, there were protests - to no avail. Eventually meetings were not even held in the presence of the Flag. This may seem trivial, but it is basic to the problems we face today. These are symbols of the golden mean - the yardstick of the rule of law.

To the revolutionaries, symbols are of great importance - their symbols denoting victory and peace are universally recognized. Both are used as tools of revolution. So too is the Soviet clenched fist, and the Nazi salute. The red tie and pocket square are also symbols. Symbols send a

message to the initiate, and are too often supinely accepted in their apparent context by the innocent.

Quietly, and with a minimum of publicity, our legal system is being transformed, with no value judgement placed on the alterations. Thus, the Court decisions on the Tahoe Regional Area Plan have created a whole new body of law, which has not yet impacted public consciousness, because it has never been publicly disclosed.

Similarly, the relationship between law-abiding citizens and the criminal element of society is being altered. Protection of the 'rights' of criminals all but blots out the rights of the victims. For the same reason, this is only being recognized as its impact is felt on society.

Proliferation of 'laws' affecting the use of private property have made giant inroads against the citizen whose natural bent is to live within the law. Such citizens can become violators of law in all good will, simply by being ignorant of the altered relationship of the 'government' to property, or the redefinition of applicable 'law'. Now, efforts are being made to have "enforcement officers" working out of planning departments, to police private property for infractions of the Planners' codes (which they call 'law'), and the totalitarian tool of citizens spying and reporting on their neighbors is openly encouraged through media hype.

It is chilling to watch as citizens respond to the failure of their representatives to serve the true responsibilities of government to protect and defend their rights, by 'helping' law enforcement through reporting "violations" to 'authority'. This strategy was an important part of the control systems in both Germany and the Soviet Union.

When the media reports any of these incidents, it does so in as matter-of-fact a manner as possible, which makes a shocking revelation seem routine.

A lesson on this failure of the press to relate cause and effect can be found in the memoirs of Hermann Ullstein (expatriate quondam publisher of a news empire in pre-Hitlerian Germany). Ullstein found refuge in the United States when the pogroms began. He lost his empire, his family and his fortune when he had to flee his native land.

In his autobiography, written after his escape from the tyranny of Hitler, Ullstein went into detail about the failures of the press -including his own- to truthfully report what the National Socialists were doing to the Republic of Germany. When he saw the same failures of the press in this country he was impelled to issue a poignant warning of the inherent danger in the silence of the press here about matters of tremendous import.

With great courage, this expatriate told how he found the situation here almost identic to that which had existed in his country, and in which he had been an active participant, up to a point. When he finally realized what the silence of the press was supporting in Germany, he tried desperately to enlist the rest of the German press in a campaign to oppose the programs Hitler was implementing piecemeal, but was unsuccessful. By then, it would have been suicidal for the press to reverse the policies they had instituted.

Ullstein wrote in his autobiography:

"Suddenly, one day... a frightening discovery was made, (of) a highly treasonous plot, revealing Hitler's subversive program... The population was seized with a sudden fear... plans to confiscate all foodstuffs and private property... the police were to surrender to the Storm Troops... sale and purchase of provisions were forbidden... anyone refusing to work for the

State was to be forced into starvation... Martial law was to be proclaimed... Anyone disobeying the orders of the Storm Troops was to be punished by death... those found to be in possession of firearms were to be shot at sight... "

It has not 'happened suddenly' in this country, but all those provisions of the Boxheim Paper which Ullstein listed now exist here, with the exception of openly admitted "punished by death" and "shot at sight". Even these, while not spelled out in documents, have yet been included by actual deeds. The rest can be found in many of the working papers which direct the strategies behind the overt moves.

Responsibility for the various sectors of these programs for this country have been dispersed among several areas of 'government', but most of them fall within the "civil emergency" functions of 'law enforcement'.

The subverters of our lawful government have been more sophisticated in their approach than those who assisted Hitler or the various Soviet dictators. A special language has been developed, which disguises the nature of the programs. Citizens who, in researching or studying such matters, stumble on to any of the workbooks of subversion have great difficulty understanding what is actually being proposed, let alone trying to translate the technical details for general consumption. A classic example of this technique was found in the bills Ronald Reagan sent to the California legislature, to give legitimacy to the management and control system.

The public press here (as in Germany), for reasons of its own, has generally ignored these grave matters. When silence is not possible, for whatever reason, the press almost invariably hides the implications they contain. In the first 'hearing' in California on the PPBS, for instance, the press was present in force when a widely diversified public testimony was given. From the so-called far left, to the so-called far right, a solid flank of opposition was presented. What appeared in the papers and on the news was simply a report that a long hearing was held, and no decision reached. No mention of either the strong opposition, or the quality or validity of it.

Our people and our country perish for lack of knowledge. Because of that information gap, many Americans find it impossible to believe how serious the present situation is. They cannot accept that there is any possibility of an imposed serfdom. They do believe that their Constitutional government still rules. The possibility of a military takeover here is rejected out of hand.

The matters about to be explored are but a key to open the door to the facts. These are matters of record, not opinion. This reporter accepts the premise of being held responsible "through time and in eternity" for their accuracy. With John Adams, we implore Americans to "take no man's word against evidence". The evidence of these facts is even now growing past denial.

Recommended reading:

"The Rise and Fall of The House of Ullstein" Simon and Schuster, 1943

It isn't too difficult for the nameless, faceless employees in the uncountable bureaucracies of our shadow government (shielded as they and their work are by anonymity and sheer numbers as well) to develop programs of a radical nature, and slip them into place in the Plan without disturbing the surface appearance of the conduct of the public business.

The plethora of seemingly innocuous legislation which piles up in legislative 'hoppers' makes a perfect receptacle for their 'innovative' bills, which thus may pass unnoticed. When some legislator or citizen happens to recognize a potentially dangerous bill, the protest is either drowned by a chorus of righteous indignation, or isolated by silence.

When the time comes to move the creations of these little-known termites into position in the framework of the legal government though, visibility brings a greater degree of resistance. As more and more of these radical moves are made, alarm on the part of citizen and official alike increases.

Such has been the case with the burgeoning effort to create a national police force.

Unbelievable at first, when this emerging effort began to appear in early planning reports, the unmistakable form of consolidated activity became clear in the mid-70s, with the advent of substantive 'criminal justice' innovations. The cautious steps timorously taken by the State agencies created in response to Public Law 90-351 (the Law Enforcement Assistance Act of 1968, LEAA), became replaced with giant strides - leading to amalgamation of police and military capabilities - in the apparent hope of keeping implementation two jumps ahead of the opposition.

In the face of strong resistance, the proponents of the scheme for integration of all facets of peace and justice operation developed several techniques designed to minimize its impact. In California, as was first exposed by this writer, a management technique known as "Delphi" was used on the prestigious Commissioners appointed to "develop goals and standards". Those goals and standards had already BEEN developed, and Delphi was used to assure that the Commissioners recommended them.

In Texas, an "unprecedented" legal interpretation lent impetus there to the consolidation. In Oklahoma, a Sheriff's "Tactical Patrol" piloted the transition into amalgamation of the police/military functions. In Colorado, the project was railroaded through a dissenting Commission. In other States, other methods, but the effort continues on a national scale, and the pattern for the future emerges as a total integrated system.

As of 1990 realization is beginning to dawn on the growing opposition that there is little in common between the stated purpose of "controlling crime", and the actuality of the efforts of LEAA/CCJ. Perhaps nothing has done more to make this recognition plausible than the so-called "war on drugs".

Numerous political and educational groups have taken up the battle against the radical incursions into traditional methods of governing in this country, but there has been no rallying point on which to focus a counterattack specifically in the CJ area. No strong resistance has appeared in local governing bodies, nor, of course, in Congress.

However, the crusading efforts of the little lady from Hanford, California, began to bring together many individual efforts, which she has now broadened in a well-conceived and -constructed effort to preserve the Second Amendment. She has now been joined by individuals as well as other

groups who have begun to see the danger.

What is needed is more such groups - a network of them, all across the country, with one central group, which would receive and disseminate information from all the others about the moves taken by LEAA/CCJ, and related agencies pressing for the same goal. It should go without saying that that central group must be small and select, and proven to have absolute integrity. It should also encourage individual action and not be a single decision-maker.

Newsclips reporting on any aspect of "criminal justice" from different areas of the nation, by a multitude of citizens would give an overview of action in this arena, which would put the lie to the claim that these are local programs, created by local citizens. Actual documents from the various State agencies which are forming State arms of the national police should be gathered and compared - to themselves, and to comparable federal documents. These would quickly provide proof positive that this is a national program, and not coincidence - that the same moves being made everywhere, are not grassroots wishes.

Wherever you are, from Maine to California, the regionalists are after your local police. By fair means or foul, "unprecedented" legal interpretation, or behavioral modification, they intend to achieve that goal.

Are YOU going to permit that to happen? It is, after all, up to you.

Addendum:

Such a group is now in the making. By the time this book is in print, it should be a full blown operation. For information, write: Conservative Coordinating Council, P.O.Box 333, Fullerton, California, 92632.

The intent behind the programs of the LEAA must be brought into serious question.

Consider. With the aid of systems specialists at Stanford University, the United States Department of Defense developed program planning for use in counterinsurgency situations. Let's take a look at that.

Since the revolution in this country is taking place within the frame of our Constitutional system, those who resist destruction of that system become 'counterinsurgents', for the 'insurgents' are the revolutionaries within the government.

In such a situation, those who uphold the lawful government are the 'dissidents'. Every man or woman who holds public office and fulfills the oath taken to support and defend the Constitution is also a counterinsurgent. And the 'government' has plans to control "counterinsurgency".

What then of the insurgents who have control of the machinery of government? They would be less than effective in seeking their goal, if they did not use every tool available to them to further their purpose. Is it legal for them to do this? Arguably, it is. Is it lawful? Demonstrably it is not.

At the time of the 'mock' military takeover of certain local governments, citizens were not really worried about the possibility that what was being done held any real threat. Our military and law enforcement personnel were, after all, Americans first. The very idea that they would cooperate in action against their fellow citizens was beyond consideration.

But since then, developments raise serious questions as to whether or not counter-insurgency control by United States troops is something to be taken seriously.

One such development is the perfecting of mind control techniques. The requirement imposed in the late 60s for police officers to be subjected to 'sensitivity training' was the first of a series of indicators that there could come a day when our police could be used to control the people they were supposed to serve. 'Sensitivity training' is one derivative of Pavlovian stimulus/response conditioning.

Another warning surfaced with the exposure of "The Politics of Change".

Yet another was recognized when Reagan's prestigious Commission on Standards and Goals for 'criminal justice' were subjected to the use of Delphi to assure their acceptance of the programmed Standards and Goals. Delphi and group dynamics are tools being used to mold and control the way people think.

With such esoteric techniques for mind changing being applied by people who have the power of control, there is no assurance that the people we depend on for protection might not be our greatest threat. No longer responsible to the citizenry, but answerable to usurped authority, and conditioned to believe that the orders they are given are legitimate, what limit will they recognize?

In addition to the problem of mind changing, there has been a gradual change in the character of personnel in law enforcement. First, there were 'Bobby's Boys' placed in the FBI. Then, the accelerating "affirmative action" programs. Academic standards for personnel were lowered to admit a broader spectrum of the community. Next, the pressures for women to do a



man's job altered the physical requirements. Natural attrition of old line officers by retirement, plus resignations of competent personnel who found it impossible to work with the new philosophy of 'criminal justice', or who could not accept the restrictions being placed on them in their attempt to carry out their historic duties.

Even their replacements, who lack the experience and knowledge which once made our protective agencies the best in the world, have found the work not only unrewarding and dangerous, but also almost futile, as criminals are sent back to the streets almost before the arresting officer finishes his report.

With this as background, consider the Don Bell Report for 25 June 1976, which detailed a program which was almost unbelievable, even in the face of these radical changes. Bell's Report concerned "civil emergency management" performed under the Law Enforcement Assistance Administration (LEAA) programs. The matters he discussed rivalled Hitler's Boxheim Paper.

It was Don Bell who gave the first national exposure of the early steps into a National Police Force, which also had all the elements needed to make a military takeover of this country possible - and, in the light of all that is 'happening' today, believable.

In his Report, Bell told of a center in San Luis Obispo, California, whose objective was development of a "peace-keeping" force, capable of controlling a "citizen rebellion" against the revolutionaries in our government. This center is called The California Specialized Training Institute (CSTI). While it was ostensibly a California program for training selected personnel from local police forces and sheriff departments, its own prospectus detailed training recruits from other States, and from federal departments as well.

With the only apparent source of funding for CSTI stemming from LEAA (a federal agency), with some funds trickling through the California Council on Criminal Justice (CCCJ - also funded from the federal level), CSTI was apparently a pilot project. As such, it could be expected that similar centers would mushroom around the country. Some must assuredly have been activated, since CSTI has been operational since 1972. It is certain sure that the strategies taught at CSTI have become an integral part of the training for new recruits to local police and sheriff departments.

The Civil Emergency Management Course (CEMC) reported by Don Bell is but one phase of the CEMCourse at CSTI. All the Courses are related, but are aimed at various disciplines in 'law enforcement'. Classes vary in size from 50 to 150 personnel, and are scheduled at intervals up to 18 classes a year. Eligibility requirements vary for different courses, but all 'students' are from some governmental agency, and many are in leadership roles. This means that what they learn at CSTI could be recycled for whole departments in the units which sent them to CSTI.

Upon learning of this unusual 'school', several of us concerned about the whole panorama of 'law enforcement' attempted to obtain copies of the manual Don Bell had discussed. It wasn't easy. It took 6 months and a variety of avenues explored, before I was able to obtain one. At that, I scored better than any of the others, as I believe I was the only successful seeker. The reward for the effort was great.

Don Bell had concentrated on the portion of the Manual which had to do with establishment of Martial Law/Rule. My own interest was directed more at the rationale which was used in the course to obtain cooperation of safety officials and other public personnel in accepting the implications involved in the training.

I only wish every red blooded American who respects the integrity of

the mind could read this Manual. For this is not just a course which presents strategies and tactics of riot control or 'civil emergency management', as it purports to be. It is designed to condition the participants to accept certain premises in order to enable them to follow orders to act against their fellow citizens.

Having come to that conclusion myself, I needed affirmation of my evaluation from someone who did not have my understanding of conditioning techniques. So I took the manual to the local sheriff, told him only enough about CEMC to assure him that there was a valid reason for asking him to study the Course, and obtain his reaction to it. When he had gone over it, he called and told me that he was bothered most about the requirement for the physical presence of the 'students' being present at CEMC in order to take the course. He indicated that the content of the course was not all that different from available literature on emergency management and the training the officers presently received. He said there did not seem to be any compelling reason for local sheriffs to bear the expense of sending their men to such a school, especially since most sheriff departments could not spare their personnel from the duties for which they were hired. It was his opinion that the deputies could study control techniques on their own. He stated that he barely had enough deputies to handle routine work in the County, and he couldn't spare even one for such a Course, even if he thought it might be worthwhile, and he stated that he did not think this course merited such expense.

This frank response affirmed my conclusion that there was some other reason than the stated one for this Course. So I went back to the Manual to try to uncover the real purpose of CSTI.

" ... In times like the present, men should utter nothing for which they would not willingly be held responsible through time and in eternity..."

This quote, and the title of this chapter, are both from the annual message of Abraham Lincoln in his State of the Union address to the Congress of 1862. It was a critical time for America then, but no more so than today.

The need for responsibility in this crisis is no less than it was then, and no one is more aware of that than this writer. The matters I am reporting are of such a nature that to misrepresent them - inadvertently or by design - would be a disservice of the greatest magnitude to you, the reader, to this country, and to the future. The things I am reporting are the truth, conscientiously reported, in the sincere belief that time and eternity hang in the balance. That these matters are not of general knowledge has allowed them to proliferate, and develop a callousness in those who are collaborating in the proliferation.

Properly used, this information could "nobly save" this nation and the world from a slavery far worse than that which concerned President Lincoln. A slavery more total and less susceptible to dissolution than any the world has ever known is being brought into being, and there is so little knowledge of it that resistance is almost nonexistent.

By ignoring or discounting this information, Americans will most certainly "meanly lose" the freedoms they have known, and the world will lose all reason to hope to achieve such freedom.

That laws which violate Constitutional or moral principles have been passed and not resisted, or, when challenged, have been let stand by the Courts, has brought a semblance of legitimacy to matters which, in all conscience, are outside the pale of any legality.

Nowhere is this more evident than in the legitimizing of the schemes described in the previous chapters, by passage of the omnibus Safe Streets and Crime Control Act.

The Law Enforcement Assistance Administration, created in that Act, has violated the letter and the spirit of the United States Constitution.

LEAA has made plans at the federal level which interfere with Constitutional provisions for the legal system of this country, and has used bribery, deceit, mind control and force to implement its plans at the local level.

Constitutional government is functioning when the people determine their needs and desires, and seek action through their representatives. LEAA denies the principles expressed in the Constitution. LEAA is revolutionary in concept, and supports revolutionary causes, groups and individuals.

These facts are also true of the so-called Planning, Programming and Budgeting System, which was developed secretly in a highly classified section of the Department of Defense. In 1960, John Fitzgerald Kennedy ordered The System made fully operational in that Department, and systems analysts and computer specialists took over direction of the protection of this country from the hands of seasoned military personnel.

The Executive Department was placed under systematic control by Lyndon Johnson. The System was introduced into State and local governments by

various ruses in the late 60s, early 70s, approved without question as a budgeting and accounting system, and has become a monstrous threat to the lives and safety of our citizens, who had no part in its acceptance, nor even knowledge of its existence.

Since its inception, LEAA has spent billions of taxpayer dollars, supposedly to reduce crime. Crime not only has not been reduced, it has increased dramatically. PPB has also cost billions, and has been a colossal failure for its stated purposes, in every known instance where it has been implemented.

Thanks to a massive coverup, these two illegitimate programs were brought together in California in the name of "civil defense", and the result is a threat to the continuance of human liberty.

Those who have monitored the activities involved in either or both of these two programs had to conclude that either the policies were being set by incompetents, or there was an official intent to create a condition of chaos in this country.

From the impish defiance of the "zoot suiters" after world war 2, attacks on law and order reached astronomical proportions by 1970. After the creation of LEAA, the rise in crime became exponential. A simple graph of the crime stats should make anyone responsible for maintaining a stable society begin a reassessment of the approach being taken since passage of the Crime Control Act!

A good place to begin any attempt to get a handle on crime would be to face up to what is being done in the public schools of this country. As long ago as the second decade of this century, responsible educators were decrying attempts to alter teaching methods and to introduce "social science" into the curriculum.

When those first interventions were being tentatively tried, a State school Superintendent warned of the "permissiveness" being brought into the classrooms. He pointed out that it was already disrupting school discipline, and that "anarchy in the schools would lead to anarchy in the nation in later years." But the "permissive" philosophers took the position that they had not had a free hand in what they were trying to do, and they continued to extend their programs.

When "situation ethics" becomes the base for moral choice, the outcome is predictable. Unless that is recognized, there is no way to achieve the stated purpose of the Crime Control and Safe Streets Act.

When the record of the implementation of that Act is examined, there is a legitimate question as to the validity of the intent behind its passage.

America, the "melting pot", was an homogenous society, until the isolated radical movements became loosely linked in their methods while still working for their separate ends.

Hyphenated Americans were at least as loyal to their adopted country as those with ancestors who arrived on the Mayflower - in some cases, even more so. Flight from tyranny heightens appreciation of a positive protection for human liberty. Those Americans whose forebears had known the chains of slavery here were perhaps even more loyal to a country whose government had reversed its own policy, and included them in the ranks of the protected.

Except for the radicals who carried a different banner - the red flag of defiance - and the intellectuals whose goal was "change", ours was a nation of neighbors.

When these two dissident groups - the radicals and the intellectuals - began to coalesce to more effectively pursue their separate goals, a major strategy was an early and continuing effort to destroy the national unity which was a hallmark of the national purpose that had made the United States of America the envy of the world. Every beachhead this coalition invaded became a pocket of faction.

It may seem redundant to state that the revolutionary goals could never be achieved while the people of this country were of one mind in their devotion to the national purpose. Assimilation into a harmonious citizenship regardless of race, creed, sex or national origin spoke louder than words to that fact. Being aware of that is necessary to understanding of the process which has created a division of the citizenry into areas of conflict. Understanding that process is essential in any effort to reverse the penetrations which threaten to topple the most inspiring governmental edifice ever constructed in this diverse world.

Destruction of the national unity has taken place throughout the fabric of our society - horizontally, vertically, diagonally, and in depth. "Conservatives" have been pitted against "liberals"; citizens against government; labor against management; children against parents; women against men; Jews against Christians; blacks against whites, and so on and on and on.

The radicals within the government departments have employed this strategy insisntently, using usurped or assumed powers to accelerate the conflicts.

It is of the utmost importance that every responsible citizen base any action they take on knowledge of this strategy.

Never succumb to "prejudice", no matter the provocation.

A most important premise on which "emergency management" is based has direct relativity to this strategy. I would there were some better way to present this to you, but the direct approach seems mandated. It could be wished that the race issue would not have to be discussed in a matter as serious as this, but since it is an integral element of the program of CEMC, it has a place here.

The matter of race has been inflated in importance, in my opinion, as a prerequisite for the most easily triggered conflict which can divide people. The fires of the holocaust are kept burning to feed the flames of racial animosity. The fact that different races had different capabilities in different competences was made a divisive element.

There is no limit to the extremes permitted the revolutionaries in

whipping up antagonism in the parameter of racial discord. There is no path available for resisters to respond which is not fraught with danger. A prestigious professor of anthropology at a leading California University was stripped of his professional credibility for presuming to disentangle fact from fiction concerning race. The mere mention of 'race' is enough to ostracize the seeker for the substance of racial differences.

One does not have to be a "racist", to recognize that there are differences among peoples - physical, mental, and capabilities. Before the 'social science' definition of 'racist', there were many competent studies conducted which had begun to provide understanding of ethnic differences. Without detouring through all the scientific evidence, the mere existence of such demonstrably racially related matters as Tay-Sachs disease, and sickle-cell anemia, for instance, are indisputable examples that differences are more than skin deep, surface configuration or color. The tragedy of this is that denial of difference hinders objective study of possible curative procedures for genetic problems.

There is another aspect of the race issue which must be recognized. That is the intended use of the 'black' communities in America as a catalyst for the takeover of the government of the United States. No one has done justice to this subject better than the late Manning Johnson, in a documentary he authored titled "Color, Communism and Commonsense". Black himself, Johnson was recruited into the CPUSA as a youth, and trained to lead the "Black Rebellion". Somewhere along the way, he began to see the hook under the attractive lure, and left the Communist movement to join the fight against radicalism. In his lectures on his years in the communist movement, he documented the real intent behind the red penetration of the black community, from his personal experiences as a manipulator of his own people. In so doing, he confirmed the testimony of other former communists who were not black.

This is not the forum to present further exploration of these matters, but this much is necessary in relation to the course given at Camp San Luis Obispo.

The LEAA would have been at a loss for a peg on which to hang the management of civil emergencies, without the conflict which had been created between black, white and brown. The "civil rights" movement was made to order (arguably, literally) for their purpose. The media reporting of that movement created acceptance among the public of radical departures from custom in the area of 'criminal justice'.

A personal experience which triggered my research into the matter of 'race' is of some importance here. Very shortly before the 'black riots', I had need of a part for a household appliance. The factory where they were made was in East Los Angeles. The direct route from our house to the plant went through Watts, where blacks had become almost the only inhabitants. It never occurred to me to take either of the long routes around Watts to go there. Unfortunately, I took a wrong turn somewhere, and got lost.

Seeing a corner drug store, I stopped and went in to inquire the way. The elderly proprietor became visibly agitated on seeing me, and I could not understand his loud demand, "White girl, what are you doing here? You get out, and you get out now!" He didn't even want to hear my query about how I could get out, but he did, all the time pushing me toward the door. He showed me the direction to go, and warned me never to come through Watts again, saying that big trouble was brewing there.

It was only a matter of weeks before Watts was burning. That experience made it clear to me that racial differences are not the issue in the 'racial unrest'. That man was truly concerned about me as a human being, and I was unaware then that his neighborhood was any different than

my own, or the one where I was headed.

By the time I obtained the manual from CEMC, I had learned a lot more about 'race', but not enough to protect me from the shock of the strategies for planned change used to indoctrinate the 'students' sent there at public expense - ostensibly to learn how to protect society in 'civil emergencies'.

The scope of the first lesson in the Manual is given as:

"Discussion of disaffection and social unrest in contemporary society with reference to historical counterparts and with a view toward human rights movements, changing values, value aberrations, and an examination of radical thought processes and activity in our nation, and, specifically within the State of California."

That is the beginning of a course which can accurately be described as a systematic modification of the values of all who enroll in CEMC. Any enrollees who might be inclined to challenge the presentation, either as to accuracy or content, would have to be already trained in strategies of mind control. Apparently none who have attended have felt competent to do that, for there is no record I have found of any such challenge.

This first session consisted of nine typed pages of social theory. No effort was made to present more than a single theoretical position. Throughout the lesson runs the threads of race/class difference/sameness, and it appears designed to create deliberate obfuscation. An article included in the lesson on one Edward Banfield, called "The Maverick of Urbanology", promotes one aspect of social theory which the lesson stated "contradicts almost every received (sic) idea about urban problems" is then picked apart and contradicted in the lesson, which then proceeds to contradict itself, necessarily leaving confusion in the mind of the auditor, and confusion is a necessary, basic element in mind changing. To the student, it must seem that values so easily dismissed have no value at all.

As indicated in the introduction cited above, this lesson is about "changing values" and "values aberration", and it is the student's values which are to be changed. And those "students" are policepeople and sheriffs, and persons with a related interest.

It would be well to remind yourself at this point of the processes of systematic management, for this course had a goal (not necessarily the one which prompts local governments to send these people to this 'school'); it has objectives - a stated objective was to change the way these people handled civil emergencies; it has information on both the trainees and the methods of achieving the desired change; and it has feedback control.

We remind you that thousands of change agents were prepared in the late 60s under the provisions of ESEA '65 through Operation PEP (Preparing Educational Planners) and other programs. We remind you that dozens of methods exist for developing systematic change in individuals and/or groups, thanks to such institutions as ISR, IPP, RAND and Stimutech.

This first lesson in civil emergency management at CEMC is a prime example of change agents at work, as it presents its social theories to a captive audience, confuses them with contradictions, and proceeds to build an action program to support the theories it needs to achieve its goal.

In this lesson, the course puts in concrete the demonstrably false social theory of a caste system in America. Ironically, perhaps the strongest argument against this theory was made by the peddler who became the richest man in the world, and whose fortune has been used to deny that

upward mobility to future Americans - John D. Rockefeller I.

Nor was it just economic mobility under our historic government. Name any field of human endeavor, and there are examples of successful men and women of every ethnic background who have surmounted difficulties to realize their dream.

Thus, when this course finds the "caste system" in America to be a cause of civil unrest, they are fighting strawmen.

Any truly serious attempt to avoid civil disorder would cancel the need for any such school as CSTI.



It was as a result of 'civil rights' excesses that strategies developed for wartime situations were moved into front and center on the Main Streets and country roads of America, in matters concerning 'law and order'.

It was as a result of the failure of the media reporting, and TV and cinema twistery, that it was possible to incorporate those strategies into traditional policing operations with minimal public objection.

Citizens are well advised to watch all of their sources of information carefully for propoganda supportive of revolutionary moves, if they are not to be diverted from productive opposition. Propaganda has proven to be a most effective path toward mass support, or as occasion requires, opposition, whichever objective is to be served.

Think back to the time after the 'black' (RED!) riots in the inner cities, and remember the way they were reported. Remember, too, the sudden blossoming on TV of a plethora of "police stories", attractively presented, and widely promoted. Most of these managed to include indictments of local police, individually or as units, either as the central theme, or inserted as an episode in an incident of the story. Remember in particular a series called SWAT.

There was nothing derogatory presented about SWAT or its cadres. These special forces were presented as a noble team of experts, daily - yes, hourly - risking life and limb for public safety and protection. They inspired public trust. SWAT, the series implied, was the answer to the incompetent, vulnerable, corruptible police shown in the 'police stories'.

And it was SWAT which finally focussed attention on the Civil Emergency Management Course at San Luis Obispo, where it was part of the specialized training.

The involvement of SWAT as an adjunct to emergency management first surfaced at a hearing held in Santa Cruz, California, where a Vietnam veteran challenged the use of SWAT teams in law enforcement efforts of the Santa Cruz sheriff's department. According to a story in the Santa Cruz MORNING STAR, members of the county Board of Supervisors "listened in stunned silence", as an overflow audience of citizens argued the fact and fiction about SWAT.

Since SWAT was developed to handle wartime situations in Vietnam, it is not surprising that its very name, STRATEGIC WEAPONS AND TACTICS, suggests a military operation. It was the position of the opponents of the use of SWAT teams by the sheriff of Santa Cruz, that their community affairs hardly warranted such a militarily sophisticated unit. It was brought out that, at that time, there were some 1500 SWAT units operating in various communities in the United States. Doubt and concern were both expressed over the possible existence of that many areas which would require the use of such military tactics. As an adjunct of local law enforcement, the citizens argued that Santa Cruz had not evidenced any such need.

The opposition was led by a Vietnam veteran, Fred Gray, who was a descendant of a signer of the Declaration of Independence, an honor student when he attended the local schools, and son of a world war 2 veteran. Backed by a former Santa Cruz councilwoman, Anne Garni, and the majority of the citizens crowded into the room, the opposition was armed with demonstrable facts. The proponents, who were few in number, led by the Sheriff, based their arguments on the TV version of SWAT, and on personal vilification of the opponents. Due to the lengthy discussion, the meeting had to be cut off at midnight, to be continued at a later date.

Speaking of the secrecy which had surrounded both the training center

in San Luis Obispo and the formation of the SWAT unit at Santa Cruz, Grey made the point that he knew of no SWAT team which had ever been approved as a result of a public hearing. He took exception to the official justification for forming the local SWAT unit "because of armed guerilla camps in the Santa Cruz mountains". He challenged the sheriff to back up that charge, and stated, "The only armed guerrillas in this County belong to the Sheriff's SWAT force."

At the continued Hearing, it was charged that SWAT teams were ultimately under the control of the U.S. military, to be ready if 'martial rule' were declared.

The Sheriff denied this, stating,

"The two men (from his department) who attended the California State Training Unit at San Luis Obispo did not get the idea that they were supposed to take over the United States."

And of course he was right about that. No American would accept training which included the knowledge that its purpose was to take over the country against the will of the citizenry.

THAT is the crux of the matter with the whole Civil Emergency movement, and specifically the Training Camp at San Luis Obispo. The full knowledge of what that Camp is about, what the training consists of, what its interlocking relationships are, what "management" means as applied to that training - none of these are disclosed to the general run of candidates for CSTI, nor to the local governments who send the 'students' there.

And apparently not to State officials, who professed ignorance when we began the search for the Training Manual.

That some of these candidates and some of the representatives who despatch them for training are fully aware of the total program is somewhat more than a possibility. And that goes for the State legislators, too.

What the average attendee at CEMC sees is the image of SWAT as a defender of the status quo and a protector against radicals and riots - themselves as heroes in the war on crime, just as depicted on the TV screen. They see the threat to "society" from civil disturbances, and their own role as protector of the public peace.

Just as it was with the PPBS, when the nature of this program, as presented by its progenitors was challenged, a protective screen was immediately drawn around it. Protest brought name changes, denials of substance, and attacks on those who would expose its true image and capability. Fred Grey read off an astounding list of acronyms for programs which were SWAT in all but name, and by then were covering the entire continent.

What started as a small, select training unit on the coast of California has now become a national concern, containing a clear and present danger to the continuance of representative government.

The second lesson in the CEMC Training Manual runs the gamut of ivory tower theory about 'mob psychology'. Again, there is almost nothing in this lesson on police methods which cannot be found in any public library or college textbook on the subject.

One thing which comes out loud and clear throughout this entire course is that there is no intent to AVOID civil disorder. The premise is always that there would be civil strife, and that it would be met with the force of 'government'.

When this is recognized, there is no surprise in finding this second lesson is aimed at preparing the "students" for the confrontation palpably ahead.

A "rumor center" is recommended as a stated means of keeping the control forces on top of emotion-loaded "false and provocative" activity. It might be thought unkind to suggest that such a center could also be used to create rumors if the need rose, but the way the course is written, this can be inferred without stretching one's imagination. The Manual points out that such a 'rumor center' could also serve as a source of information for the intelligence units monitoring the coming civil disorder.

There is a strange difference in the way this and the next three sections of the Manual are presented, which seems to justify the unkind suggestion of provocation by the civil authority. The lessons almost seem to be designed for that purpose. The text at one point states:

"Through extensive publicity, a dissident leader can get a crowd to form... publicity can be spread through newspapers and magazine articles, specially prepared bills and posters, radio and television... and word of mouth... A well-trained speaker using key words and phrases, taking advantage of local prejudices, distorting facts and using emphatic movements,"

The text then suggests:

"The timely appearance of a well-known dissident personality or symbol can be used to increase the intensity of the situation."

This entire section of the course somehow reads more like a text for ascerbating tension to obtain action from 'dissidents', than instruction on how to reduce stress in a potentially violent condition.

This lesson then begins to deal with specifics involved in crises, beginning with the nature of crowds. Here one could expect instruction on crowd control, but instead there is more 'social' explanation of mob psychology, theories of crowd behavior and crowd reactions.

Much discussion is offered on the "conspiracy theory" ("the real communists in America are aging, fuddy-duddy and discredited"); the "riffraff theory" is explained ("revolt of the downtrodden of the urban ghetto"); the "biological theory" supported ("men are violently aggressive through genetic instinct"); the "deprivation theory" accepted ("conflict between the haves and the have-nots"); the American "cultural violence" theory noted ("violence is a part of the nation's history"); and the student is ready for the CEMC question:

forward.)

As we have shown, local receptacles for data collection had been installed also in the mid-60s under the rubric of outdated courthouses, preparatory to 'modernizing local governments'. The States began to construct the intermediate collection centers once The System was assured. In California, the massive Stephen P. Teale Data Center (named for the state senator who did the most to further early moves into The System) was built to house the computers needed to store the data.

The citizen effort to mandate a thorough investigation of The System was stymied by the Attorney General, who sat on the petition signed by thousands, asking his help. As they waited a year for him to act, those citizens were unaware that his Office, even then, was building the section of The System which would serve Law Enforcement, and, in particular, the needs of the NPF.

A dominant thread in the information which was gleaned from the background papers on the PPBS was the fact that there is no way to secure the integrity of information once gathered. Some of the papers even made clear that there was no intent to attempt to secure privacy, since there were so many different needs for data. Once it has been collected, and filed in a computer, the right to privacy is no longer relevant.

These factors demonstrate the depth of the perfidy which would involve public money, time, and effort in a futile campaign for a cause doomed before begun.

When the CEMC Manual presumed to assure the 'students' that data collection was a benefit for them, it was one more lie.

In listing the various incidents for which the "use of selected and coordinated means to cope with the unexpected...event demanding immediate action" would be justified, the Manual included "labor troubles". This was interesting, because in California, State law specifically exempts labor activity from 'civil emergency' status.

There is a remark in the summary of this lesson which bears special mention:

"Record-keeping is a must... for... what occurs during a civil disorder or, for that matter, any unusual occurrence..."

This brings to mind a cartoon which accompanied an article on the Office of Management and Budget, some time ago, which addressed the loss of privacy occasioned by Big Brother's record keeping. The sketch showed an intimidated citizen, surrounded by huge fingers pointing at him, as he tried to protect himself by throwing his arms around his head. Each finger had an eye where the nail should have been. This article reflected the thinking ascribed to Hitler, that it gives these mattoids secret pleasure to turn the dagger in the wound.

Another section of the Manual gives great detail on the various adjuncts to local civil emergency management, such as troop usage and placement; allowable military action under California law; use of intermediate force, such as riot batons and chemical control agents, up to and including the use of deadly force. (Remember the Boxheim Paper? It is of interest that this Manual does not rule out such directives as "punishable by death" and "shoot on sight".)

This section also deals with the Special Mission Forces, such as the Chemical Dispersal Team, armed with shotguns, grenades and launchers, as well as rifles. It is here that SWAT enters. Also included are automatic weapons and armored vehicles. And all of these are in preparation for use

as 'mutual aid' against that list of individuals given as the kind who "get involved in civil disturbances".

In the next section, the Manual goes into the critical area of federal involvement in matters of civil disorder. Here it is more revealing in what it does not say than in what it does. Pointing out that the president may, under State law, be requested to assist in "restoring law and order", and that he has the discretion not to respond, it also correctly notes that he has the power under the Constitution to enter on his own authority. He may call the State militia into federal service, or utilize whatever armed force he deems necessary.

What the Manual does NOT mention are the powers which were developed under Project Safer California and the Public Safety Agencies, nor the Executive Orders on Emergency Powers, and the extent to which these would be used.

There is nothing on the surface in this Course which could justify setting up such a center as CSTI. Any and all of the material in this course (except that noted here) could just as well have been printed and sent around to the several interested agencies. The logistics of moving personnel which can ill be spared from the duties for which they were hired, and of housing and feeding them at San Luis Obispo are of sufficient complexity that there had to be some overriding need to do so. Unless that need was the physical presence of these candidates at CSTI for other than the stated reasons, the whole thing becomes an exercise in futility, and an inexcusable waste of the taxpayers' money. If it was the physical presence which was that overriding need, the burden of proof should be on the 'government' to show cause for that need.

If there were some other need than to brainwash these candidates, it is high time for that need to be shown. It is also high time for this whole program to be looked into by the proper authority. Under the circumstances, the only proper authority would be the citizenry whose future hangs in the balance - Americans with professional expertise in the fields of systems analysis, military and police disciplines, psychology and psychiatry, who can be objective about this whole system. It should go without saying that they should also possess an unassailable record of support for and dedication to the Constitutional principles of our lawful government.

In a number of places, the CEMC Manual identifies its purpose as "prompt support to and restoration of civil authority". "Civil authority" is not at issue. What is desperately needed now is support and defense of Constitutional authority.

Nothing in the Manual provides hope for that.

The elected county sheriff has been high on the "enemies" list of the people-planners, but his place on the list was threatened when the bills proposing "Court reform" began to surface.

As is the case with so many revolutionary bills and programs, it is often not possible to follow them through to their disposition, because before any given measure reaches resolution, another, sometimes far more critical, begins the process. It was so with SCA 48 and SB 1500 which were the first California bills on 'court reform'.

The overwhelming opposition seemed to doom these measures from the first hearing held by the State Senate Finance Committee. The self-styled "author" of these bills had to make concession after concession, to first one group, and then another, in his effort to sweeten the pill enough to make it palatable. First, he offered to withdraw inclusion of the sheriff in elimination from the Court. At long last, he withdrew the county clerk from elimination.

Faced with a determined "solid front" of all California's sheriffs and county clerks, he made his final concession: to amend the bills to give local option in the sheriff vs marshall controversy. It was too little, too late, though, because the Finance Committee voted the bills down anyway, 9-3.

That it should have been the sheriff who was the first to prove expendable in this scheme, makes an interesting point. What circumstance would make it more important for the county clerk to be removed from the Courtroom, rather than the Sheriff?

Since this attempt was only to remove the Clerk from Court duties at this time, there must be some circumstance which bridges the Clerk's office with the criminal justice system. To demonstrate that removal of the Clerk is not solely linked with "court reform", you should know that there was another bill going through committees in the legislature at the same time which proposed that the County Clerk be relieved of "any obligation imposed on him by law" with respect to his Court responsibilities. That bill would replace the Clerk in the Court with an appointed executive officer.

There IS one circumstance which impacts both the regular duties of the County Clerk and those performed as an officer of the Court. That circumstance is his obligation with respect to data processing.

County Clerks were a transmission belt, through which data processing was brought into local government. Whatever persuasions were used to obtain their aid - time saving; election tallies; budget - it was the County Clerk who was in the center of local promotion of The System. Not that those Clerks necessarily knew the potential of what they were told was 'data processing'.

A County Clerk worth his salt (and most of them are), would, of necessity, have to do a lot of extra work to become familiar with this new 'tool', to use it in a manner which would justify the cost to the supervisors. It is unlikely that these studies would take him into the area of potential usage, but they would surely bring the Clerk to the point where he/she would recognize that 'potential', should she/he see it in actual operation.

The other side of this coin is the involvement of the criminal justice system with data processing, and there's the rub. For, in law enforcement, 'data processing' was quite different from the application used by the County Clerk at that time. With all possible speed, criminal justice has

brought 'data processing' to its ultimate capacity, just as was done in the schools. In the view of the people-planners, what is NOT needed on the law enforcement scene, is an elected official who knows the workings of 'data processing', and can recognize an aberration from its stated capability.

There was evidence even then that, in certain areas of criminal justice, the ultimate use of 'data processing' was already operative. When that use became general, the County Clerks would know, and there aren't many (if any) who would sit still for that.

At the time, judges were not involved to any great extent in the CJIS (Criminal Justice Information System), and they were not familiar with data processing, either. But if the "court reform" were to be slipped through somehow, these older judges were scheduled to be replaced at one fell swoop, long before they would have been able to place The System in context with what was being done in Criminal Justice, and there was an army of the "new breed" of judges, fresh from the training stables, ready to move on to the bench in their place, with no constraints on their acceptance of systematic management of justice.

Even then, there was an undercurrent of feeling that the long years of planning behind the scenes had reached a point where its time had come, and "court reform" was the method chosen to get it into the judicial area.

While the sheriffs were already involved to a degree in CJIS, they were not generally computer experts, and their use of The System was limited to what could be called legitimate law enforcement. Those who were already involved in systematic management were answerable only to the State Attorney General, because the public was totally innocent of the knowledge that there was a System designed to manage their lives. To whatever degree the Sheriff's had gone along with 'data processing', it's unlikely that many of them would go along with the full potential use of the System - if they knew what that potential was.

HOWEVER, it WAS the Attorney General of California, who sat on the citizen demand for an investigation of the Planning, Programming and Budgeting System for a full year, without apparent concern about the charges made against this System. All that time, his Office was building the California section of the national CJIS, which interfaces with other States, other data systems, and the federal government.

Does it begin to come clear why "they" are after your County Clerk? And your local police and sheriffs?

As the rest of the facts about 'criminal justice' unfold, you will understand why it is vital that all Americans be on guard against incursions into the ranks of these Constitutionally created protectors of local control.

## The Authoritarian State - 107 - An Unparalleled Disaster

Time was (though it was never the better part of wisdom) when it was possible for a 'conservative' to note the 'liberal' position on an issue, take the opposite side, and not be too far wrong. No more!

With the growing familiarity of the functioning of the mind achieved by social engineers, strategies for diversion of individual decision-making have been activated to create the 'climate for change' needed to make their revolution a success. Positioning today could well be a trap to divert the unwary.

Before discussing our case in point, a caveat: Due to the proliferation of revolutionary moves versus our limitations of time and personnel, often it is impossible to monitor a specific incident in depth, or even follow it to its ultimate disposition, even if it was a vital element. This was the case with The Criminal Justice Act of 1975, known as S 1.

With Frank Wilkinson (activist participant in Operation Abolition) leading the attack on this "repressive legislation" (his term); the American Civil Liberties Union (ACLU) baying at his heels; and the Dean of the University of Chicago Law School (incubator for future creators of "non-laws") panting along behind, it would seem that S 1 could not be all bad. But don't put your money on it.

Two professors from Yale and Harvard respectively have described S 1 as "an unparalleled disaster for the system of individual rights in the United States". Any fair analysis of the bill would have to arrive somewhere near agreement with that evaluation, from any political position.

That S 1 ever got out of any subcommittee of the Congress of '75 is amazing, for it was in no way a 'liberal' bill, and that Congress was overwhelmingly 'liberal'. On the other hand S 1 is even less of 'conservative' lineage. What it is, is a bill that someone (or, more likely, some group) wanted a great deal to serve an undisclosed purpose.

A whole new vista of speculation opens, when the "why" of S 1 is included in consideration of it. The stated goal for it was generally accepted, despite the fact that both the arguments presented by its "authors" and the specifics of the bill itself denied any measure of truth in the stated expression of "need".

Support for S 1 included statements that "present law in the United States has been written piecemeal"; that our laws today are "haphazard", conflicting, contradictory, and "imprecise".

That recent Congresses have created a mountain of unrelated and irrelevant "laws", on which have been piled an unbelievable blanket of "non-laws" by the Executive, the Courts, State and Local governments, and uncounted administrative bodies, does not provide grounds for dumping centuries of progress toward a legal system unsurpassed in the history of the world, especially in the protections of civil liberties.

But those charges about our present system are hauntingly familiar. These are the same vague, unsubstantiated attacks, using the same language as those which were used successfully to entice the people into accepting 1313s State Constitutional revisions! It seems more than possible that both sprang from the same source.

There is a strong presumption that the legislative record of S 1 could have been the foundation which permitted the Supreme Court to determine that desecration of the Flag is an exercise in "civil liberty". Certainly neither the Constitution, the Bill of Rights nor precedent gave any grounds for the amazing outcome of the case of the radical militant.



The arguments for S 1 included an overemphasis on "codification", to the point where it might seem to be the main goal. This is demonstrably inaccurate. Codification might have been an objective, but the Goal of the bill was reform. This is verified by its history, its content, and even by its title.

Of the charge by its 'liberal' critics that S 1 is "repressive", let it be said that much of the 'controversial' material in the bill was simply transferred from other titles in the Code. If it was repressive in S 1, well, it always was. Its critics are able to ignore the fact that they (or their precursors) were strangely silent as earlier Congresses passed those "repressive" measures one by one. It was 'conservatives' who protested that original "piecemeal" legislation, while the 'liberals' found no problem with it then.

Under S 1, Constitutionally provided powers of Congress were diminished by legalizing extended jurisdiction of the Federal government to the States and even local governments, in violation of the 9th and 10th amendments, and by unConstitutionally delegating authority to the Supreme Court, under a formula similar to that given to the Executive by Executive Orders.

The provisions of S 1 were such that it should have been continually monitored, for there have been a series of incidents since 1975 which strongly suggest that such authority as was provided in that bill has indeed become a fact of life in these United States.

One such provision appeared in SubChapters B and C of Chapter 11. That section provided a legal base for government action against citizens who might resist an illegal coups such as Kennedy prepared in the series of Executive Orders on "emergency management". Or as might have been necessary in the transfer of power which took place when Nixon was forced out of office. Or, for the troops prepared at Camp San Luis Obispo.

If S 1 was doomed by the hue and cry it raised, it is possible that the pertinent parts of it were attached to some other, more innocuous legislation, kept low profile, and passed unnoticed.

With the mounting pressures for a "climate for change", S 1 represented a critical move on the road to revolution, and the portent for the future is bleak indeed, if the elements of S 1 become "the Law of the Land".

Resistance groups already concerned with incursions against the established justice system should keep a close eye on the innovations imposed in the name of "modernization", "codification", and "streamlining" laws and enforcement in this area, and present their findings to their compatriots.

The wise course in any effort to restore our Constitutional heritage will be to make every effort to avoid situations in direct conflict with the rules and regulations which presently are held to be "law". This will not always be possible, but using "civil disobedience" as a tactic is entirely different when it is done to AID "change". Those RESISTING "change" will find the 'laws' have different meaning when applied to them.

*document  
section*

**UNITED REPUBLICANS  
OF CALIFORNIA**

**Be It Resolved . . .**

**SUBJECT: OPPOSE CANDIDACY OF REAGAN**

**WHEREAS: Ronald Reagan has made eloquent conservative speeches while his deeds have served the liberals;**

**WHEREAS: Despite Reagan's CLAIM OF CONSERVATISM SINCE 1950, the left dominated his POLITICS PRIOR TO 1960;**

**WHEREAS: During his 1966 GUBERNATORIAL RACE, Reagan selected liberal Rockefeller men to run his campaign, and upon election, his APPOINTMENTS continued in the same pattern, excluding conservatives;**

**WHEREAS: Reagan SUPPORTED NIXON'S LEFTIST POLICIES, PRAISED KISSINGER, but BETRAYED CONSERVATIVE CANDIDATES,**

**WHEREAS: Reagan PROMISED ECONOMY but doubled the State Budget and raised taxes;**

**WHEREAS: Reagan actively PROMOTED REGIONAL GOVERNMENT, contrary to his expressed philosophy of local government;**

**WHEREAS: Under Reagan, LIBERAL EDUCATIONAL PROGRAMS accelerated, and PPBS, a budgetary process of political change, established, moving public schools toward total state control;**

**WHEREAS: Reagan also betrayed conservative principles in the areas of PROPERTY RIGHTS, INCOME TAX WITHHOLDING, GUN CONTROL, MEDICINE, MENTAL HEALTH, WELFARE REFORM, CRIME CONTROL. ETC.**

**THEREFORE BE IT RESOLVED: That UROC oppose Ronald Reagan as candidate for President or Vice President, and urge Americans nationwide to carefully scrutinize his record.**

Adopted In UROC State Convention  
Santa Maria, California  
May 4, 1975



ROBERT H. BURKE

COMMITTEES

MEMBER

Rules  
Education  
Transportation

# California Legislature

70th ASSEMBLY DISTRICT

EDUCATION

From  
The Acquisition of Knowledge  
to  
Programmed, Conditioned Responses

Several months ago, my office began accumulating material which had particular significance in the area of Planning, Programming and Budgeting Systems, because of its potential use as a tool of fiscal accountability in the field of education.

As we searched into the information available on the application of this subject in education, it became increasingly difficult to see any relationship between the proposed programs and fiscal accountability. It was apparent, after a study of the methods proposed for use by the schools for accountability purposes, that fiscal accountability was being minimized, and the techniques were being promoted for achieving behavioral objectives.

Other, seemingly unrelated, organizations, projects and programs were uncovered because of their influence on the application of accountability methods. They were parts in a puzzle - by themselves, each of these projects appeared to be either harmless, or expressions of someone's "dream". When linked together, with other "harmless" programs, they were no longer formless, but could be seen as an entire package of plans, outlining methods of implementation, organizational structures (including flow charts), computer utilization, use of behavioral profile catalogs, and goals and objectives determination.

\* \* \*

The information available in government reports is voluminous.

\* \* \*

(In California) The Bureau of Program Planning and Development (was) charged with the responsibility of administering Title III, ESEA, programs within the state. They report to the Advisory Commission (on School District Budgeting and Accounting - the agency ostensibly created to 'develop' the System-ed.), and to the State Board of Education. The Bureau's two contributions which have been of major influence in determining the direction of California education are, 1), Operation PEP (Preparing Educational Planners), a program for the training of administrators in systematic planning procedures, systems analysis techniques, program evaluation techniques, cost-benefit analysis, and planning, programming and budgeting systems (PPES), and their application as a means of directing behavioral change; and, 2), the funding of twenty one regional planning centers.

\* \* \*

There is a demonstrated difference in intent between the Federal Congress and those charged with administering Title III. The bureaus and agencies which were ... part of the overall organization, play an integral role in transmitting directives from ESEA in Washington, D.C., to the classroom teacher. Built into this organizational system are guidelines which have to be followed, methods for reporting progress and accomplishments, and methods for screening, to retain only the suitable projects. It appears that only those tools which are considered to be useful to the "elite" remain.

THE MACHINERY FOR THE MANAGEMENT AND CONTROL OF SOCIETY IS HERE - IT IS A REALITY. (Emphasis added - ed.)

The system provides for methods by which behavior of students is measured, as well as the subtle process by which behavior patterns are "improved" until they meet the requirements as set forth in the planning and programming.

In the hands of those who would use this instrument of thought control and societal management to further their own ends, this entire concept of educational management has become a "people control mechanism", and has caused many in the educational field to lose sight of the real goal and purpose of education.

A Report Prepared by  
the Office of  
Assemblyman Robert H. Burke

From Assemblyman Burke's Newsletter for February, 1971:

"All of the elements necessary for the implementation of a plan for the management of society through the public schools of the United States are now functioning..."

Retyped, edited and arranged for spatial reasons.

Patient gradualism has, since the beginning, been a continuing characteristic of the movement which has systematic management as its core component. Witness:

1913  
**PUBLICATIONS OF THE GENERAL  
 EDUCATION BOARD**

*OCCASIONAL PAPERS, No. 1*

**THE COUNTRY SCHOOL  
 OF TO-MORROW**

BY  
**FREDERICK T. GATES**

6

A VISION OF THE REMEDY

Is there aught of remedy for this neglect of rural life? Let us, at least, yield ourselves to the gratifications of a beautiful dream that there is. In our dream, we have limitless resources, and the people yield themselves with perfect docility to our molding hand. The present educational conventions fade from our minds; and, unhampered by tradition, we work our own good will upon a grateful and responsive rural folk. We shall not try to make these people or any of their children into philosophers or men of learning or of science. We are not to raise up from among them authors, orators, poets, or men of letters. We shall not search for embryo great artists, painters, musicians. Nor will we cherish even the humbler ambition to raise up from among them lawyers, doctors, preachers, politicians, statesmen, of whom we now have ample supply.

GENERAL EDUCATION BOARD  
 17 BATTERY PLACE NEW YORK CITY  
 1913

TO CREATE A DEPARTMENT OF EDUCATION AND TO AUTHORIZE  
 APPROPRIATIONS OF MONEY TO ENCOURAGE THE STATES  
 IN THE PROMOTION AND SUPPORT OF EDUCATION

HEARINGS  
 BEFORE  
 THE COMMITTEE ON EDUCATION  
 HOUSE OF REPRESENTATIVES  
 SIXTY-EIGHTH CONGRESS  
 FIRST SESSION

H. R. 3923

A BILL TO CREATE A DEPARTMENT OF EDUCATION, TO  
 AUTHORIZE APPROPRIATIONS FOR THE CONDUCT OF SAID  
 DEPARTMENT, TO AUTHORIZE THE APPROPRIATION OF  
 MONEY TO ENCOURAGE THE STATES IN THE PROMOTION  
 AND SUPPORT OF EDUCATION, AND FOR  
 OTHER PURPOSES

Printed for the use of the Committee on Education



WASHINGTON  
 GOVERNMENT PRINTING OFFICE  
 1924

This first attempt to provide a centralized education structure included two departments devoted to collection of data and statistics --

RESEARCH WITH RESPECT TO CURRICULA AND METHODS OF TEACHING

Rapidly changing conditions make traditional courses of study inadequate. Material that does not function in the life of the pupil makes up too large a part of each child's course of study. Children's talents are only partly developed and their time wasted by poor methods of teaching. Research data are needed by local school authorities in the scientific formulation of curricula.

A Department of Education, through a division of research, could have ready for distribution on request compilations of the best current thought on educational aims and objectives, minimum essentials in courses of study and scientific methods for realizing the desired outcomes in terms of habits, skills, and attitudes.

RESEARCH IN SCHOOL COST ACCOUNTING AND BUDGETING

\$1,500,000,000 is spent annually for public schools.

Much of this money is obtained by methods that are obsolete and unjust according to taxation authorities.

State school funds are often distributed to local districts in such manner that they do not accomplish the purpose for which they exist—equalization of educational opportunities.

School accounting is in such a chaos that it is impossible to collect comparable statistics on school costs for the guidance of local boards.

Many boards can not tell with accuracy how much their own schools cost.

A Department of Education would work out and popularize standardized methods of school accounting and budgetary procedure, thereby guarding against the waste of school money.

-- one for budgeting and accounting  
 one for "realizing desired outcomes in ...habits, skills and attitudes."

FEDERAL INVESTMENT IN THE USE OF RELIABLE  
 INSPECTION DEVICES IN CLASSICAL SCHOOL BUILDINGS  
 OF THE DIST. TO PROTECT RIGHT

HEARING  
 COMMITTEE ON THE  
 GOVERNMENT OF THE  
 HOUSE OF REPRESENTATIVES

# IMPLEMENTING PPB IN STATE, CITY, AND COUNTY

A Report on the 3-3-3 Project  
 STATE-LOCAL FINANCES PROJECT OF  
 THE GEORGE WASHINGTON UNIVERSITY  
 Washington, D.C. June 1968

In cooperation with:  
 The Council of State Governments  
 The International City Managers Association  
 The National Association of Counties  
 The National Governors' Conference  
 The National League of Cities  
 The United States Conference of Mayors

This was the PROCESS  
 used to insert the  
 MANAGEMENT AND CONTROL SYSTEM  
 into State and Local  
 governments.

The following chart illustrates one possible phasing of orientation and initial training in relation to the first stages of implementation of a PPB system.

Participants	Timing of Orientation	Purpose of Orientation
Top administrative officials	Initial exploratory phase	To determine whether to initiate a PPB system.
Central staff	First phases of staffing	To indicate the expected result.
Chief executive	Before formal decision to implement	To determine whether to proceed.
Agency and departmental officials	Before and/or in response to instructions to implement	To set the stage for agency and departmental staff training.
Agency and departmental personnel	As a first phase of implementation	To acquaint personnel with the what and why of PPB.
Legislative staff and legislatures	When decision is made to work toward implementation, or when initial work is underway	To gain (a) participation in review of general jurisdictional objectives, (b) understanding of uses for legislature, (c) legislative support.
Public	When preliminary structuring of program has been completed	To gain (a) public discussion and (b) understanding of purposes of PPB implementation and support of effort.

While the above statement in the Report implies that this chart is only a 'suggestion', the fact is that, in all the cases we have investigated, the legislators and the public WERE the last to know.

Who the first were has been all but impossible to trace. The names listed in this Report are unknowns. The Report hints that certain elected officials approved, but doesn't name those. However, involvement of 1313 is omnipresent.

## Also available:

**PROGRAM PLANNING FOR STATE, COUNTY, CITY** by Harry P. P. Hatry and John F. Cotton (72-page Monograph)  
 Discusses consideration in instituting a PPB system in a state and local government and examines the nature of the analytical process which is integral to the system.

**PLANNING FOR EDUCATIONAL DEVELOPMENT IN A PLANNING, PROGRAMMING, BUDGETING SYSTEM** prepared by the State-Local Finances Project, for the Committee on Educational Finance, National Education Association (46 pages)

This document seeks to provide the framework within which PPB systems can develop for schools through cooperation of all those interested in furthering an integrated PPB system for education as well as for other governmental services.

**FUNCTIONAL FEDERALISM: GRANTS-IN-AID AND PPB SYSTEMS** by Selma J. Mushkin and John F. Cotton, assisted by Gabrielle C. Lupo (208 pages)

Formulation of concepts underlying a federal grant-in-aid system and a review of the wide variety of prescriptions for change that has been offered.

**PPB PILOT PROJECT REPORTS FROM THE PARTICIPATING 5 STATES, 5 COUNTIES, AND 5 CITIES** (155 pages)

Summary of PPB implementation experiences of the 15 governments as presented in their final reports.

**CRITERIA FOR EVALUATION IN PLANNING STATE AND LOCAL PROGRAMS** (42 pages)

Discusses the nature of the evaluation criteria (i.e., measures of effectiveness) needed for evaluating alternative program proposals for major government functions. An initial list of such criteria is presented. This study was prepared for the Senate Subcommittee on Inter-governmental Relations and is available through that subcommittee.

**LONG-RANGE REVENUE ESTIMATION** by Eugene P. McLoone, Gabrielle C. Lupo, and Selma J. Mushkin (122 pages)

Deals with the importance, purpose, and methodology of long-range revenue projections for advance fiscal planning by states and counties. Includes chapters on the projection of sales taxes, income taxes, property taxes, and fees and charges.

**AN OPERATIVE PPB SYSTEM: A COLLABORATIVE UNDERTAKING IN THE STATES** by Selma J. Mushkin and Marjorie C. Willcox (22 pages)

Examines the relationship between planning and implementation of a PPB System.

**THE SEARCH FOR ALTERNATIVES** by Selma J. Mushkin and Brian Herman (66 pages)

Examines the question of how the processes of program review that call for a search for alternatives can best contribute to new public products and new methods of delivering them as public services.

**ENCOURAGE IMPROVED PLANNING IN STATE AND LOCAL GOVERNMENTS** by Selma J. Mushkin, Harry P. Hatry, and Marjorie C. Willcox (54 pages and Appendix)

An assessment of present federal grants for planning assistance to states and localities in the light of the requirements of a PPB system and recommendations for new legislation.



1313 EAST SIXTIETH STREET  
CHICAGO, ILLINOIS 60637

# THIRTEEN

VOLUME 5  
NUMBER 1

CENTER FOR PUBLIC ADMINISTRATION

# THIRTEEN

SEPT.-OCT.  
1969

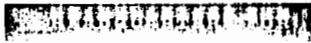

- American Public Welfare Association
- American Public Works Association
- American Society of Planning Officials
- Building Officials Conference of America
- Council of State Governments
- Federation of Tax Administrators
- International Association of Assessing Officers
- International Institute of Municipal Clerks
- Municipal Finance Officers Association
- Public Personnel Association
- Public Administration Service

This bimonthly newsletter is published jointly by the organizations at the 1313 Center for Public Administration. It is designed as a means of communication among their hundreds of governing board members, officers, and staff members. It is available to others on request from any of the above organizations or from Headquarters Services Division, Public Administration Service, 1313 E. 60th St., Chicago, Ill. 60637.

The organizations at 1313 are entirely independent of one another. However, they share a number of convictions . . . the improvement of government is a matter of paramount importance . . . the responsibility for this improvement rests primarily on public officials . . . they, in turn, need the best support in research, publications, training, and other technical assistance and services that can be provided . . . such support requires liaison between the theoretician and the practitioner. Shared views such as these have led to the development of important resources at 1313 for individual and collective use.

Not of general knowledge is the fact that 1313 does not confine its projects to the United States, but involves the whole world in its plans. Equally obscure is the part 1313 has played in integrating the management and control system into government departments.



ADP increases production for the Malaysian farmer without change in his ancient method of rice planting (see story below).

## Computerized Credit System Provides More Rice for Malaysia

Though the farmers of Malaysia still plow with the water buffalo, a computer credit system has been designed by Public Administration Service to assist them in doubling their rice production. This agriculture credit system, proposed and partly financed by the World Bank, will supply cash, fertilizer, and other production aids to thousands of submarginal and marginal farmers in the Muda area of Malaysia. The credit system, along with an irrigation project, will give Malay farmers sufficient water and fertilizer for a second crop of rice every year. Farmers will receive loans to begin double cropping in February 1970.

Most of a farmer's harvest income is now used to live for the six months between harvesting and planting. With double cropping, the time from harvesting to planting will be reduced to one month. It is expected that eventually farmers will be able to finance their own planting and harvesting, but at least for a few years, they will probably need credit to finance the second planting.

A Malaysian farmer in this new

system will request a loan from a local credit center of his choice—a miller, planter board, cooperative, farmer association. The center will use computer-prepared forms to record loan data—of request, amount, decision to approve loan.

The farmer's request will be forwarded to a center

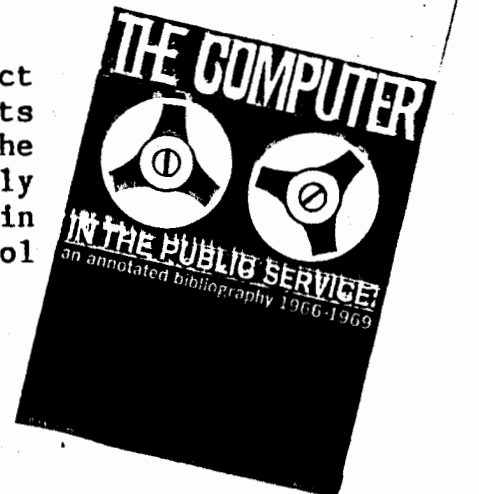

When Congress rejected the National Resources Board and its Plan, by large majority, a cabal of diehard senators met in closed sessions, and together a package of legislation designed to implement the Plan piecemeal.

The installments contained in these pages appeared as separate articles in the

NEW YORK JOURNAL-AMERICAN  
CHICAGO HERALD-AMERICAN  
PITTSBURGH SUN-TELEGRAM  
DETROIT TIMES  
MILWAUKEE SENTINEL  
BALTIMORE NEWS-POST  
SAN ANTONIO LIGHT  
SEATTLE POST-INTELLIGENCER  
SAN FRANCISCO EXAMINER  
LOS ANGELES EXAMINER  
ALBANY TIMES-UNION

## Snares for American Liberties

Describing and Exposing a Highly Organized Campaign to Impose a Socialist Economy upon the American People

By E. F. TOMPKINS

### SOCIALIST LEGISLATION

(Published August 29, 1945)

**J**UST before the United States Senate went into recess, 17 Democratic Members met in caucus and welded themselves into a bloc to support a drastic program of Socialistic legislation when Congress reconvened on September 5.

The 17 Senators, now serving as the Congressional spearhead for these radical interests, adopted at their caucus a beguiling "12-point" program as a tactical cover for their specific legislative intentions.

The program is significant in what it DOES NOT say.

It is a statement, in vague and general phrases, of "purposes" and "policies" which anyone, demagogue or patriot alike, could adopt as campaign slogans.

Furthermore, the program does not even indicate the precise nature and direction of legislation which the 17 Senators and their following intend to foist upon the country.

That omission was especially deceptive and reprehensible for the reason that a large group of bills had PREVIOUSLY been introduced in Congress, many of them bearing the names of Senators in the group.

These are among the bills which the 17 Senators will press as carrying out their "platform".

*EACH of the bills is an artfully disguised SOCIALIST measure.*

And this set of bills is the REAL program to which the 17 Senators and their Communist-Socialistic following are committed—a program for a SOCIALISTIC AMERICA.

These are SOME of the bills:

#### 1—FULL EMPLOYMENT BILL OF 1945.

This bill is simply the American version of the Beveridge plan which the Socialist-Labor Government intends to apply in Great Britain.

#### 2—SMALL BUSINESS FINANCE BILL.

This bill would put the United States Government in the commercial banking business with a billion-dollar corporation having access to the resources of the Federal Reserve System.

#### 3—GENERAL WELFARE BILL.

This bill is the American replica of the Beveridge "social welfare" plan in Great Britain.

Under the guise of amending and extending the Social Security Act, it would inflict an annual twelve-billion dollar payroll-employment tax upon the country, would establish Socialized Medicine under the dictatorship of the Surgeon General of the United States, and would inflate the existing Social Security Agency into a vast irresponsible bureaucracy with coercive political powers.

#### 4—FEDERAL EDUCATION BILLS.

There are two bills purporting to provide Federal aid to education in backward areas.

One would expend \$300,000,000 a year, the other \$550,000,000.

Both would apportion funds politically, irrespective of State or local need, and both would give the U. S. Commissioner of Education dictatorial powers over State and local educational authorities.

#### 5—REGIONAL AUTHORITY BILLS.

Several "regional authority" bills have been introduced in the 79th Congress.

These bills would disregard State lines, infringe State rights and inflict upon the "regions"—without the people's ascertained assent—a Federal system of "planned economy".

#### 6—NATIONAL HOUSING BILL.

Purporting to "aid" private enterprise in the building construction industry, this bill would perpetuate and magnify Federal activities instituted as emergency projects in the depression period.

Through Federal "subsidies" at an annual rate as high as \$133,000,000—in addition to \$28,000,000 a year in pre-war authorizations—and a billion-dollar Federal insurance plan, the National Housing Administrator would sit as a czar over a large segment of the building industry for at least fifty years.

#### 7—NATIONAL SCIENCE FOUNDATION BILL.

This bill would set up a new centralized Federal bureaucracy and endow it with power to dominate all scientific research, private as well as public.

It would inject politics into a non-political sphere and would interfere with scientific and industrial institutions and with the national defense.

Unquestionably, sane and sound legislation may be needed in some or all of these fields.

But the need for GOOD LAWS should not be used as A SUBTERFUGE for UNSOUND and SOCIALISTIC innovation and encroachment.

Not all of this package became law then, but today, all of it is in effect, some of it modified, some even in more radical form.





## RESOLUTION No. 447-74

### OF THE BOARD OF SUPERVISORS OF THE COUNTY OF EL DORADO

WHEREAS, the Board of Supervisors of El Dorado County has consistently upheld the principle of local elective government, elected by popular vote of the citizens involved; and

WHEREAS, essential to such elective procedures is an informed electorate, basing their decisions freely on accurate information, openly debated, and

WHEREAS, inherent in this process is the right of the citizens not to be misled, coerced, or otherwise inhibited in the free exercise of the elective franchise, and

WHEREAS, any effort to nullify these rights is in direct conflict with the intent of the Constitution of the United States and the State of California, and

WHEREAS, it has been brought to the attention of this Board that a report has been issued by the Institute for Local Self Government, asserting the authority of the Governor's Office, the Office of Intergovernmental Management, and the Council on Intergovernmental Relations, which presents prima facie evidence of a deliberate, calculated attempt to mislead, coerce, and inhibit the rights of citizens to determine the need for, the desirability of, and the method to bring about changes in the structure of their local governments; and

WHEREAS, the "Summary of Conclusions" in this report states:

"There must be a CLIMATE FOR CHANGE in order for the restructuring of local government to occur, whether this restructuring involves drastic reform, reorganization, modernization, or a minor administrative realignment. While the following does not represent an exclusive list, the factors mentioned here are those which most often create such a climate:

- a. COLLAPSE of government's ability to provide such needed services;
- b. a CRISIS of major magnitude;
- c. a CATASTROPHE that has a physical effect on the community;
- d. the CORRUPTION of local officials; "
- e. the high COST of government and the desire for higher level of services."

(emphasis in the original); and

WHEREAS, it would appear from this document, which is entitled "The Politics of Change in Local Government Reform", that it was received by the Council on Intergovernmental Relations; and

WHEREAS, the techniques described in this report have apparently been used in San Diego County Government Reorganization, in the Consolidation of the Contra Costa Fire Department, and the current effort to consolidate Sacramento City and County; and

WHEREAS, the cited report actually states that LOCAL GOVERNMENT IS MEETING THE PROBLEMS OF TODAY, and that no pressure is building up to cause the citizens to wish the desired reforms, then recommends the use of "change agents" to DEVELOP a climate for change, using diversionary tactics to confuse and disorient the citizens, and to deceive them about the need for reform; and

WHEREAS, this Board of Supervisors is at a loss to understand any legitimate function served by such proposals as these;

NOW, THEREFORE, BE IT RESOLVED by the Board of Supervisors of the County of El Dorado, in the State of California, on this 17th day of September, 1974, that all persons by whom this present Resolution is received be informed that this Board herewith goes on record in strong opposition to any such attempt to deprive the citizens of the State of California, and particularly of El Dorado County, of their right to determine for themselves the forms and functions of their government, and

BE IT FURTHER RESOLVED that this Board notify the Governor of the State of California, the Institute for Local Self Government, the Office of Intergovernment Management, the Council on Intergovernmental Relations, the League of California Cities, the California Supervisors Association, and the Boards of Supervisors of the several counties of the State, that such political abuse as is disclosed in this document is intolerable, and

BE IT FURTHER RESOLVED that the Board of Supervisors of El Dorado County hereby calls on all responsible citizens and officials to be on guard against any such attempt to usurp their rights and privileges.

PASSED AND ADOPTED by the Board of Supervisors of the County of El Dorado at a regular meeting of said Board, held on the 17th day of September, 1974, by the following vote of said Board:

ATTEST:

CARL A. KELLY, County Clerk and ex-officio  
Clerk of the Board of Supervisors

*Carl A. Kelly*  
Deputy Clerk

Ayes: Franklin L. Lane, William V. D. Johnson  
W. P. Walker, Raymond E. Laywer,

Noes: Thomas L. Stewart  
None

Absent: None

*Franklin L. Lane*  
Chairman, Board of Supervisors

I CERTIFY THAT:

THE FOREGOING INSTRUMENT IS A CORRECT COPY OF THE ORIGINAL ON FILE IN THIS OFFICE.

DATE .....

ATTEST: CARL A. KELLY, County Clerk and ex-officio Clerk of the Board of Supervisors of the County of El Dorado, State of California.

By .....  
Deputy Clerk

(The undersigned affirms that the above is a true and accurate copy of the resolution adopted on 17 Sept 74, by the above named Board.)

SCORPA  
1333 Lincoln St., #289  
Bellingham, WA 98226

Key to Acronyms

- OMB = Office of Management and Budget
- BoB = Bureau of the Budget
- DoD = Dep't of Defense
- OE = Office of Education
- HEW = Health, Education & Welfare
- DoE = Dep't of Education
- NRPB = National Resources (Planning) Board
- ACIR = Advisory Commission on Intergovernmental Relations
- 1\* = Council of State Gov'ts
- 2\* = International City Managers' Assoc.
- 3\* = Nat'l Assoc. of Counties
- 4\* = Nat'l Governor's Conf.
- 5\* = Nat'l League of Cities
- 6\* = U.S. Conf. of Mayors
- 7\* = Nat'l Assoc. of State Budget Officers
- (\*and State/Local Affiliates)
- ICUG = Intergovernmental Council on Urban Growth
- CCIR = Cal. Council on Intergovernmental Relations
- SEDPC = State Electronic Data Processing Committee
- IBEDP = Intergovernmental Board on Electronic Data Processing
- DGS = Dep't of General Services
- OMS = Office of Management Services
- EDP = Electronic Data Processing
- ADP = Automated Data Processing
- AIM = Agency of Information Management
- ACSBA = Advisory Committee on School (District) Budgeting and Accounting
- ACIDP = Advisory Committee on Integrated Data Processing
- CEIS = Cal. Education Information System
- EIAC = Education Innovations Advisory Commission
- PACE = Projects to Advance Creativity in Education
- ERIC = Educational Resources Information Centers
- FRCs = Federal Regional Councils
- JtComEGE = Joint Committee on Educational Goals and Evaluation
- REAs = Regional Education Agencies
- LEAs = Local Education Agencies

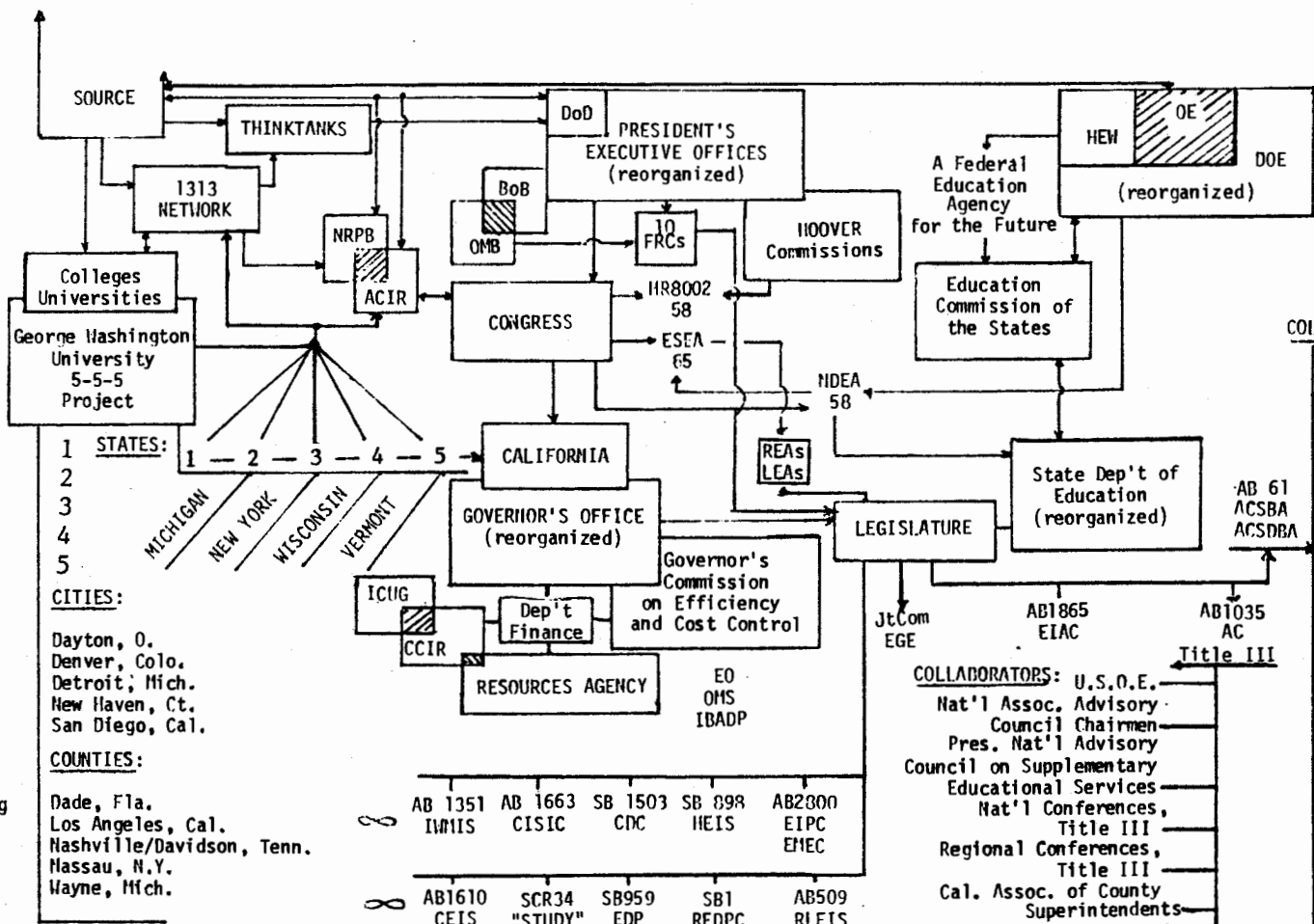

GRAPHIC of PPBS STRATEGY for CHANGE

- COLLABORATORS:
- Cal. Teachers Assoc. - NEA
  - Colleges/Universities
  - Peat, Marwick, Mitchell
  - CTB/McGraw/Hill
  - Arthur D. Little
  - Cal. Taxpayers Assoc.
  - Cal. Assoc of School Business Officials-NASBO
  - Assoc. of Cal. School Administrators - AASA
  - Cal. School Boards Assoc.
  - Projects to Advance Creativity in Education
  - Cal. Chapter, AFT - AFT
  - Cal. Chamber of Commerce -CoC
  - AFL-CIO
  - Cal. Council of Churches -NCC
  - League of Cal. Cities - NLC
  - N.Y. PPBS Project
  - Cal. School Employees Assoc.
  - Educational Resources Information Center (ERIC)
  - Advisory Commission on Goals and Evaluation
  - Joint Committee on Goals and Evaluation
  - Nat'l Forum on New Planning and Management Practices
  - Education Commission of the States
  - Cal. Education Information System
  - President's Nat'l Advisory Conference on Innovation
  - Cal. County Superintendent's Association
  - U.S. Office of Education
  - \*\*\*

THE PRAGMATIC APPLICATION OF DECEIT

THE TANGLED WEB

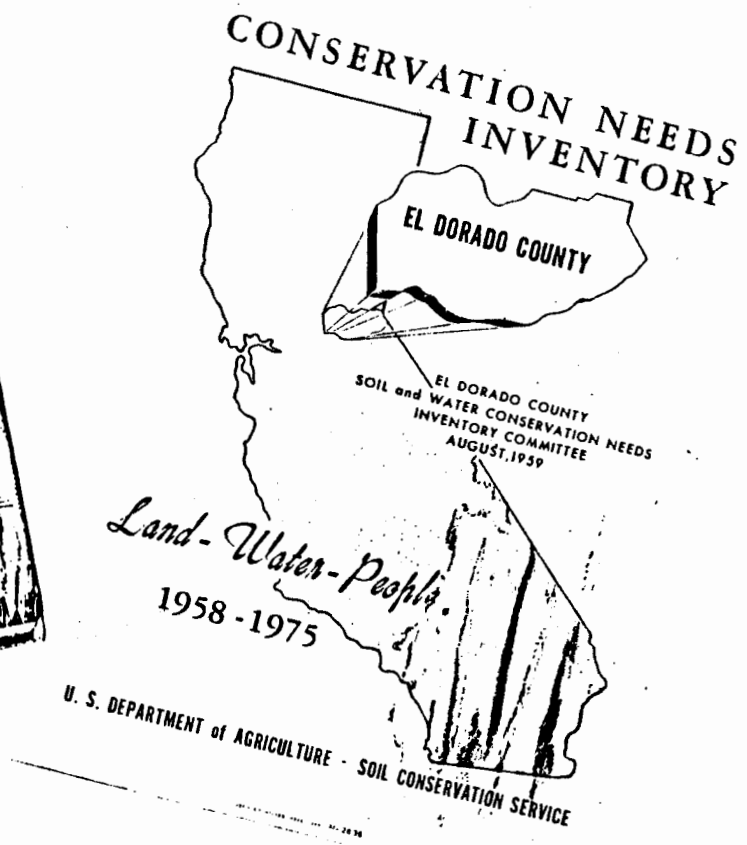
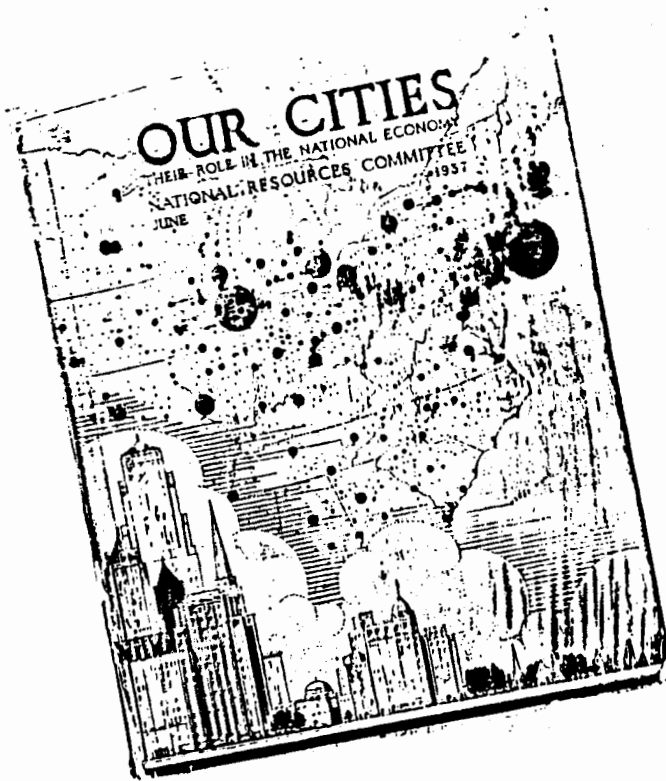

In 1971, SCIENCE Magazine printed an article by three "social scientists", entitled "Conditions Favoring Major Advances in Science"(Vol. 171). Accompanying the article was a chart, which does more to demonstrate the seditious nature of the System than any single source yet uncovered. This was not the purpose of the article, nor acknowledged by the collaborators, but the chart proves a sequential relationship of those "major advances", during the period from 1900 to 1967.

It would strain credulity to accept as 'coincidence' the USE of those very "major advances", in the same time frame, in the promotion and implementation of an apparent conspiracy to "so alter the structure and operation of the United States Government" as to constitute a revolution within the form of that government.

Sixty two such "advances" were listed by number in the article. Those listed below are demonstrably involved in the System.

- |  |                                      |
|--|--------------------------------------|
| 3. Theory of one-party organization and revolution     | V. I. Lenin                          |
| 4. Psychoanalysis and depth psychology                 | Freud, Jung, Adler                   |
| 6. Gradual social transformation (Fabian)              | B & S. Webb, G. B. Shaw, H. G. Wells |
| 9. Pragmatic and behavioral psychology                 | J. Dewey, et al                      |
| 10. Learning theory                                    | E. L. Thorndike, C. Hull, et al      |
| 11. Intelligence tests                                 | A. Binet et al                       |
| 13. Conditioned reflexes                               | I. Pavlov                            |
| 15. Sociometry and sociograms                          | J. L. Moreno                         |
| 17. Large-scale nonviolent political action            | M. K. Ghandi                         |
| 18. Central economic planning                          | Q. Krassin, G. Grinko (USSR)         |
| 21. Quantitative mathematical studies of war           | Richardson/Wright                    |
| 24. Quantitative political science and basic theory    | C. Merriam et al                     |
| 34. Culture, personality and comparative childrearing- | R. Benedict, M. Mead et al           |
| 40. General systems analysis                           | L. v. Bertalanffy et al              |
| 41. Attitude survey and opinion polling                | G. Gallup et al                      |
| 45. Operant conditioning/learning/teaching machines    | B. F. Skinner                        |
| 47. Operations research and systems analysis           | P. M. S. Blackstone et al            |
| 51. Computers  | V. Bush et al                        |
| 53. Information theory/cybernetics/feedback systems -  | C. Shannon, N. Wiener                |
| 55. Cognitive dynamics of Science                      | J. B. Conant et al                   |
| 59. Cost-benefit analysis                              | C. Hitch                             |
| 60. Computer simulation of social/political systems    | W. McPhee et al                      |

(The numbers are those assigned in order of occurrence by the compilers)



# THE ITEM

PASADENA HIGH SCHOOL

Pasadena, California, November 1923

## THE PREVENTION OF WAR BY MEANS OF A UNITED NATIONS OF THE WORLD

By Manche H. Wallcott

We are told that the next war will last only three days, possibly a week. At the end of that time all the people, on this planet at least, will be dead. Perhaps this will be the method used to rid the world of war, at least it would be effective. The number of destructive, devastating methods of fighting which have been invented during the few years of supposed peace since the Great War, is appalling. Gases have been pounded more deadly than any yet used; gases which will not only kill people, but everything else which they come in contact, whether it be plant or animal. Also methods of carrying these gases have been perfected so

naked among the ruins of the war or if, they must bear intolerable burdens of debt "which shall not be thrown off before the next rash catastrophe, the next war."

If war continues, not only the physical constitution of the races will be shattered, but their mind and spirit will be debased. War has always been a brutalizing force. One writer says, "Modern civilization simply cannot afford to risk what attempting the suicide of war. There is no new race at hand to build up what we tear down."

Consequently an obviation of all wars is needed. But we are not the only race, not the first generation, of people to conceive of this idea. Think back over the alliances and leagues of history—from as early a time as we have any record, or there has been a code of fundamental principles to keep people, tribes, and nations from a precipitate resort to arms. In the middle ages there were holy leagues organized by the ages later there have been elaborate co-operations of power; treaties; all of international law have they failed? Is it not because it is too much power or political expediency or because it is existing fundamental power and economic promotion of war? "We must not be deluded by the prospect of a good thing"; must we not have been vexed that war must be justly that all war is wrong; is it not because of the last venture to say, not more than ought for other circumstances pretext for an ever, or wealth, to fight or to good thing"; must we not have been vexed

that war must be justly that all war is wrong; is it not because of the last venture to say, not more than ought for other circumstances pretext for an ever, or wealth, to fight or to good thing"; must we not have been vexed

### An Historic Document of Universal Brotherhood

It is significant that the strongest minds and the most powerful influences are now organizing to bring the Nations into a united whole, concentrating their indomitable energies and their vast resources for the betterment of mankind. Ambassador Bryce recently said: "I do not believe there ever was a time when the people were so heartily desirous of maintaining peace throughout the world. I am convinced that there is not one of the great powers that desires to see the plague of war."

far from its consummation being only a dream, it is so near to reality that it lies to-day within the power of man to found the League of Peace.

Political economists have been working for some years on a practical plan to give tangibility to this movement. "The Journal of American History" now officially records the first draft of a Constitution of the United Nations. This draft is the result of life-long investigations and intimate relations with the Nations by William Osborne McDowell, LL. D. of New York. In presenting it to the public, Dr. McDowell says: "I record this in 'The Journal of American History' as the proper repository for historical record. It is not my expectation nor intent that it will be immediately criticized. My desire is wholly to give origin to a movement that I believe will ultimately become the practical solution of not alone the cessation of war, but the foundation upon which the economic, moral and intellectual as well as political, future will be based. I have endeavored to make this first draft a document of world democracy, giving representation to the organized movements in the various nations tending toward the betterment of humanity. There are more than ten million intellectuals connected with these various organizations, and by uniting their interests into a cabinet composed of a representative of each organization, I am confident that it would be the most tremendous moral force waited for a single purpose that the world has ever known, and that the political thought of the future I invite to these needs the criticism and the suggestions of every reader of this first draft. My only claim is that if the Constitution of the United States, written forty-six separate commonwealths, is practical, then a Constitution for the United Nations of the World is practical."

## The Journal of American History



VOLUME II  
FIFTEENTH NUMBER  
(1908)

EDITED BY FRANKLIN EDWARDS MILLER

NUMBER IV  
FOURTH QUARTER

### America's Appeal for United Nations

Rulers of Nations can set before themselves no higher aims than the promotion of international good understanding and cordial friendship among the Nations of the World—it is the surest and most direct means by which humanity may be enabled to realize its noblest ideal, and its attainment will ever be the object of my constant endeavors  
—King Edward VII

THE most fearful war of the century is coming soon. After the war will come world-peace—the highest development of the race in this cycle. This is the prediction made a few days ago by a distinguished political economist, based upon the complications that have arisen in the Old World, and the information that more money is being expended in the preparations for war by the powers than ever before in the history of the world. This same preparation, however, is one of the most forceful factors in preserving peace, and, whether or not the age of arbitration must find its

birth in a last final struggle for physical supremacy, that age is not only coming, but it is practically here. The peoples of the earth, and their rulers and leaders, are united in the edict that war must cease and reason must triumph. The human race has risen above carnage; its moral and intellectual sense now repels war. The death throes of the demon may be violent for a time, but the end is near. In recognition of this "The Journal of American History" dedicates this book to the United Nations of the World, linking their armorial bearings with the symbols of the oak and the laurel, and unfurling the American flag on the field of white, an ensign of Peace and emblem of unity among the nations

**First Draft of Constitution of the United Nations**

Upon the termination of the term of office of the Peacekeeper, he shall receive the title of an Elder Statesman. His salary shall be continued to him for life, at the rate of one-half the amount paid him during his term of office, and if upon his decease he shall leave a widow surviving him, she shall receive during her life an annuity equal to one-quarter of the salary of the Peacekeeper, but shall not act as a representative of the United Nations, and being subject to any law in his executive power or authority whatever, but shall not be considered as a member of the Peacekeeper's Council. The assistance of his Co-Adjutors and the assistance of his Co-Adjutors shall be available for the execution of all these to be done before the Peacekeeper shall have been elected. The Peacekeeper shall have the assistance of his Co-Adjutors and the assistance of his Co-Adjutors shall be available for the execution of all these to be done before the Peacekeeper shall have been elected.

Andrew Carnegie struck a universal note when he recently said, "We believe the psycho-social moment approaches when a decided step forward can be made. Personally, I am a convert to the League of Peace idea for protection to the peace of the civilized world. It requires only the agreement of a sufficient number of nations to establish this. Since the civilized world is now united by electric bonds into one body, in constant and instant communication, it is largely interdependent, and rapidly becoming more so. War now involves the interests of all, and therefore one nation has no longer a right to break the peace without reference to others. This is no new idea, but the extension of what has already been done. Recently six nations—Great Britain, France, Russia, and our own country—combined forces in China under command of a man general for a specific purpose which was successfully accomplished. We urge this plan as the speediest means of attaining international peace. . . . So

Reprinted from Civic Center Sun (L.A.) August 27, 1951

# A 'Mock' Military Government 'Take-Over' or Rehearsal for the Real Thing in the U.S.A.?

PRACTICE MAKES IT EASIER TO TAKE OVER



Mayor J. Roy Klotz of Culver City, California, is being escorted from the City Hall by the Army Military Government Reserve unit.

The Army Military Government Reserve unit has taken over nine small cities around Los Angeles in July 1951. The village taken over was Palm Springs. The press in Palm Springs, referring to the fashionable winter resort of the Reserve's permanent summer "maneuvers" for the Reserve Officer's School, was thought to be one of the FIRST OF THE COUNTRY.

This first of its kind exercise, conducted where little has as often a ring as ever was heard in the name of MILITARY GOVERNMENT, was held in September, 1950.

**COINCIDENCE?**  
Is it coincidence that this MILITARY GOVERNMENT is the result of legislation for the year 1950?

**TRAINING?**  
The date of September, 1950, plus the date of the military training legislation makes possible the MILITARY GOVERNMENT.

**SLICK TRICK? TRIAL B?**  
Was the military so sure of its ability to push the date-line forward by a year? The press reports indicate relative the American public in Palm Springs the civilian will

## YES, AMERICANS, YOUR ARMY AND NATIONAL GUARD ARE BEING TRAINED, SOVIET-STYLE, TO PUT DOWN PROTESTS BY AMERICAN CITIZENS.

Pictured below is Soviet-style training. Part of the force dress as protesting citizens, the rest (on the "government" side) then "control" and disperse them. In order to "communize" a free nation, small farms must be destroyed and food production drastically reduced. (PIK will reduce our food supplies). Food shortages are then used by the "government" to control the people. Obey and you get food; disobey and no food. However, in all countries the farmers resisted, as they are doing in America. Therefore, the local and State Police forces, the National Guard and the Army are then trained and psychologically conditioned to control, arrest, or even shoot some of the protesting farmers. It is going on here.

10—RICE LAKE (WIS.) CHRONOTYPE—March 9, 1953



RIOT TRAINING WAS the program for the day Saturday for members of the Rice Lake National Guard unit. The scene was the Rice Lake Fair grounds where the "bad guys" made up a group protesting the lake over of a member's farm and had gathered and attempted to hold onto the buildings. The "rioters" were members of the Combat Support unit from Eau Claire, also part of the First Battalion of the 128th Infantry. Above, the guardsmen are confronted by the sign carrying protesters while below, the guardsmen, moving steadily in formation, force the protesters back. Another part of the program involved the Rice Lake police and Sheriff Wally Larson who manned a roadblock. About 90 local guardsmen took part in the training.



CURRENT TRENDS

PSYCHOLOGY IN THE WORLD EMERGENCY

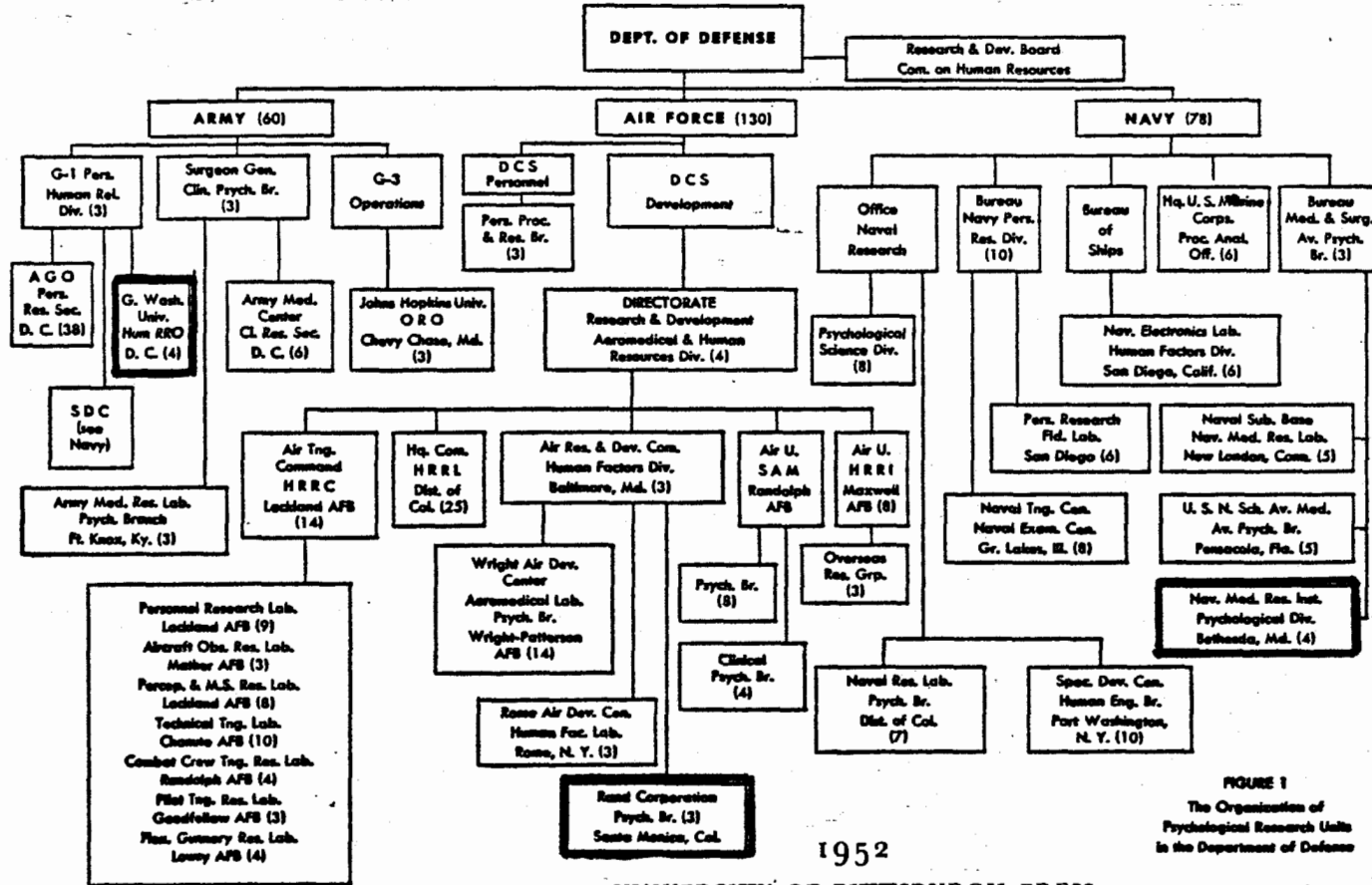

FIGURE 1  
The Organization of  
Psychological Research Units  
in the Department of Defense

In the mid-sixties, a document was 'leaked' out of a "thinktank" which caused a furor:

**FACTORS OPERATIVE IN A  
POST - ARMS  
CONTROL SITUATION**

CONTRACT NO. AF 49(638)-1411

NORTH AMERICAN AVIATION, INC.  
SPACE AND INFORMATION SYSTEMS DIVISION  
AEROSPACE SCIENCES DIVISION  
OPERATIONS ANALYSIS DEPARTMENT  
APRIL 1965

**METHODOLOGY**

MATRIX ANALYSIS - TO DETERMINE GROSS INTERACTIONS

DYNAMIC CONTEXTUAL ANALYSIS - TO DETERMINE RELATIONSHIPS & FACTORS

- SELECT U.S. OBJECTIVES - (INCLUDING MILITARY OBJECTIVES & GOALS)
- SPECIFY CURRENT SITUATION - RELEVANT TO ARMS CONTROL
- ANSWER QUESTION - "ARE OBJECTIVES BEING ACHIEVED?" IF NO;
- SELECT STRATEGIES TO CHANGE SITUATION
- PREPARE SCENARIO - LIST RELEVANT, CREDIBLE & FEASIBLE ACTIONS
- ANALYSE SCENARIO - TO DETERMINE RELATIONSHIPS

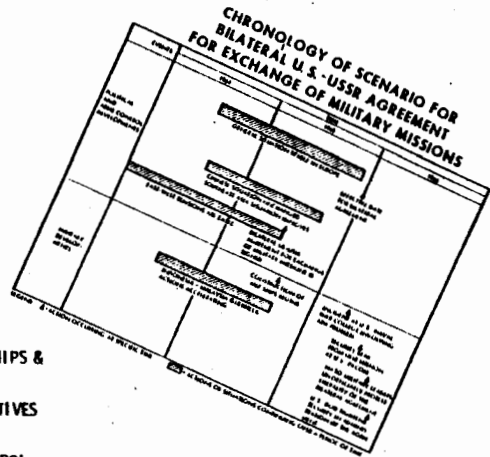

**CHRONOLOGY FOR PARTIAL DISARMAMENT & FINAL GENERAL DISARMAMENT TREATIES**

EVENTS	TIME												
	1965	1966	1967	1968	1969	1970	1971	1972	1973	1974	1975	1976	
POLITICAL AND ARMS CONTROL DEVELOPMENTS	<ul style="list-style-type: none"> <li>▲ INCREASED COOPERATION IN ARMS CONTROL</li> <li>▲ ADDITIONAL U.S.-USSR AGREEMENTS TO CURB SPREAD OF REASONABLE MATERIAL FOR WEAPONS USE</li> <li>▲ COMRADESHIP CHINA ADMITS TO THE ILL</li> <li>▲ U.S. WITHDRAWS ECONOMIC SUPPORT FROM CUBA</li> <li>▲ U.S. AND USSR AGREEMENT FOR RESTRICTION OF OBSCURE BOMBER AIRCRAFT</li> </ul>	<ul style="list-style-type: none"> <li>▲ COMRADESHIP CHINA ADMITS TO THE ILL</li> <li>▲ 10-NATION AGREEMENT PREVENTING PROLIFERATION OF NUCLEAR WEAPONS AND FURN</li> <li>▲ INDOCHINA EXPLODES NUCLEAR OVERBLOW</li> </ul>	<ul style="list-style-type: none"> <li>▲ TREATY FOR NUCLEAR-FREE ZONE IN CENTRAL EUROPE</li> <li>▲ BELIEF INTERNATIONALIZED UNDER ILL CONTROL</li> <li>▲ NUCLEAR-FREE ZONE IN CENTRAL EUROPE PLACED IN EFFECT</li> </ul>	<ul style="list-style-type: none"> <li>▲ ALL FOREIGN AID TO INDONESIA DISCONTINUED</li> <li>▲ INDOCHINA GOVERNMENT ADOPTS COMPLICATORY FOREIGN RELATIONS POLICY</li> <li>▲ TREATY FOR FREEZE AND LIMITATIONS ON TESTING OF STRATEGIC OFFENSIVE AND DEFENSIVE VEHICLES (SDOV)</li> </ul>	<ul style="list-style-type: none"> <li>▲ NATO NAVAL SURFACE FLEET IN OPERATION</li> <li>▲ STRATEGIC NUCLEAR DELIVERY VEHICLES (SDNV) TREATY PLACED IN EFFECT</li> <li>▲ U.S.-USSR TREATY HALTING ALL PRODUCTION OF FURN</li> </ul>	<ul style="list-style-type: none"> <li>▲ OBSERVATION POSTS AGREEMENT IMPLEMENTED</li> <li>▲ NEGOTIATIONS IN PROGRESS FOR AGREEMENT FOR PARTIAL DISARMAMENT REDUCTION IN ALL CATEGORIES</li> </ul>	<ul style="list-style-type: none"> <li>▲ EFFECTIVE DATE FOR GENERAL DISARMAMENT REDUCTION TREATY</li> <li>▲ AGREEMENT REACHED</li> <li>▲ NEGOTIATIONS IN PROGRESS FOR FINAL GENERAL DISARMAMENT</li> </ul>	<ul style="list-style-type: none"> <li>▲ COMPLETION OF EXECUTION OF PARTIAL DISARMAMENT TREATY</li> </ul>					<ul style="list-style-type: none"> <li>▲ COMPLETION OF EXECUTION OF FINAL PHASE DISARMAMENT TREATY</li> </ul>
	MILITARY DEVELOPMENTS	<ul style="list-style-type: none"> <li>■ U.S. FIGHTS LIMITED WAR VS NORTH VIETNAM AND COMRADESHIP CHINA, INCLUDES DESTRUCTION OF AIRCRAFT PLANTS</li> </ul>	<ul style="list-style-type: none"> <li>▲ LARGE-SCALE REVOLUTION IN CUBA-GUAYAMA GOVERNMENT OVERTHROWN</li> </ul>	<ul style="list-style-type: none"> <li>■ U.S. FORCES IN EUROPE BEING REDUCED</li> </ul>									
<p>■ EAST-WEST TENSIONS REDUCING NORTH-WEST INTERNATIONAL RELATIONS IMPROVING IN GENERAL</p> <p>■ GAP OF USSR INCREASING</p> <p>■ GENERAL DISARMAMENT IN PHASED REDUCTIONS AS PROVIDED FOR IN TWO TREATIES</p> <p>■ GENERAL DISARMAMENT IN PHASED REDUCTIONS AS PROVIDED FOR IN TWO TREATIES</p> <p>■ MALAYSIA DEFEATING INDONESIA CENTRAL INDONESIA'S MILITARY POTENTIAL DETERIORATING</p> <p>■ MARKED GROWTH IN STATUS OF FRANCE AS A NUCLEAR POWER</p>													

LEGEND ▲ ACTION AT SPECIFIC TIME ■ ACTIONS OCCURRING, OR SITUATIONS EXISTING OVER A PERIOD OF TIME

Following in the wake of State Department Publication 7277, which called for unilateral disarmament by the United States, the apparent proposals here for overthrow and/or suicide of "unfriendly" heads of state, were bloodcurdling. With the exposure of the system of management and control, it became evident that this was the first public knowledge that our 'government' was devising "game plans" for war by means of the "spaceage servomechanism" sometime known as Planning, Programming and Budgeting. The rapid deployment to Iraq in August of 1990 of two hundred thousand +/- service personnel and materiel strongly suggests just such a "gameplan" as this. Congress should require the executive office to produce the "forecast" for The Gulf action. Dollars to doughnuts, the General who was fired had seen it!





A Speech delivered at a Public Dinner given by a large Number of the Citizens of New York (Chancellor Kent in the Chair) in Honor of Mr. Webster, on the 10th of March, 1831.

I have said, Gentlemen, what I verily believe to be true, that there is no danger to the Union from open and avowed attacks on its essential principles. Nothing is to be feared from those who will march up boldly to their own propositions, and tell us that they mean to annihilate powers exercised by Congress. But, certainly, there are dangers to the Constitution, and we ought not to shut our eyes to them. We know the importance of a firm and intelligent judiciary; but how shall we secure the continuance of a firm and intelligent judiciary? Gentlemen, the judiciary is in the appointment of the executive power. It cannot continue or renew itself. Its vacancies are to be filled in the ordinary modes of executive appointment. If the time shall ever come (which Heaven avert), when men shall be placed in the supreme tribunal of the country, who entertain opinions hostile to the just powers of the Constitution, we shall then be visited by an evil defying all remedy. Our case will be past surgery. From that moment the Constitution is at an end. If they who are appointed to defend the castle shall betray it, woe betide those within! If I live to see that day come, I shall despair of the country. I shall be prepared to give it back to all its former afflictions, in the days of the Confederation. I know no security against the possibility of this evil, but an awakened public vigilance. I know no safety, but in that state of public opinion which shall lead it to rebuke and put down every attempt, either to gratify party by judicial appointments, or to dilute the Constitution by creating a court which shall construe away its provisions. If members of Congress betray their trust, the people will find it out before they are ruined. If the President should at any time violate his duty, his term of office is short, and popular elections may supply a seasonable remedy. But the judges of the Supreme Court possess, for very good reasons, an independent tenure of office. No election reaches them. If, with this tenure, they betray their trusts, Heaven save us! Let us hope for better results. The past, certainly, may encourage us. Let us hope that we shall never see the time when there shall exist such an awkward posture of affairs, as that the government shall be found in opposition to the Constitution, and when the guardians of the Union shall become its betrayers.

*Daniel Webster*

DANIEL WEBSTER.

# section IX

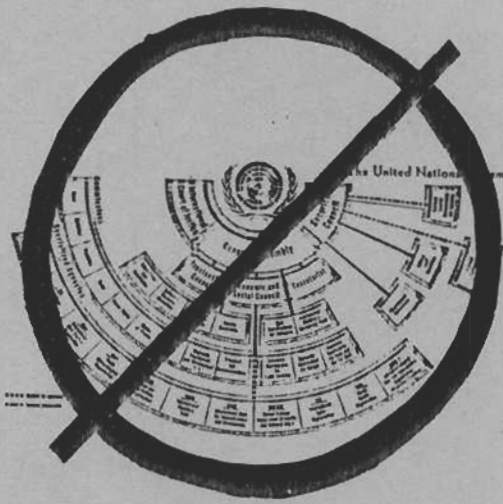

## What of the Future?

ch:	pa:
108 History Reveals Horrors	IX - 1
109 The Natives are Restless	IX - 4
110 Heroes for the 21st Century	IX - 7
111 Who is Responsible? NOT the Whistleblowers!	IX - 10
112 The Purge	IX - 14
113 Who's in Charge Here?	IX - 17
114 Now or Never	IX - 21

The infamous Helsinki meeting, calculatedly held during Captive Nations Week, 1975, is a matter of history.

As reports of the horrors taking place in Tienanmen Square in "Peijing" began to penetrate the consciousness of American supporters of "friendly relations" with the Red Dragon, shock waves rolled around the world.

Although there are still some who lived through the tragic days when the machiavellians permitted the iron curtain to be drawn around the Baltics, enslaving those stalwart nations and those of their people who were not massacred - in precisely the same manner as was done in China - no voice was raised to make that connection. No newscaster admitted turning back in thought to that time, to recall the anguish which resulted from the unbelievable events, although there is a public record in the press of the time of some depth. The massacre in Hungary was reported on television, and scenes in Tienanmen could be used interchangeably with the Hungarian obscenity.

Nor was instant recall of the events accompanying the more recent Soviet "withdrawal" from Afghanistan permitted to trickle through a reluctant 'news' media.

When I was asked to put together this book, the publisher wanted me to write it in fiction format. I refused to do that, because I was convinced that if anything I might contribute to understanding of this revolution was to have any value, it had to be demonstrably, irrefutably factual.

Had a novel been written, using the actual events of the enslavement of one nation after another at the bloody hands of the tyrants who are bent on world conquest - no matter the cost - as a theme, one can imagine the reader comfortably thinking, "Horrible! But, of course, it couldn't really happen."

But this is not fiction. It is fact, written in blood on the pages of time - and Tienanman proves once more that history is the greatest mystery of all.

What forces permitted this tragedy? Why did not honorable men resist with every ounce of their strength? Why didn't the United Nations intervene? Where was the United States? Where, England, France, the Netherlands?

After the terror in the Baltics, the United States Congress did hold hearings, looking, they said, for answers to these - and other - questions.

Out of the flood of refugees from the Soviet prisonhouse of nations and races\*, a stream of those benighted people passed through the Committee chamber, telling, for the record, of their experiences during those black days.

One refugee, after giving his personal account, was asked:

"But then, you saw it coming?"

The answer was slow in coming:

"...ye-es...we saw it coming..."

Then the inevitable question:

"What did you do about it?"

With indescribable sadness, the answer came:

"Nothing... I was too busy earning a living... But if I knew then what I know now, there is nothing I wouldn't have done - nothing!"

One fact emerged from those lengthy hearings, beyond the shadow of a doubt. The United States could have prevented the enslavement of those people. But it did not.

"The Soviet Union looked with disfavor on unfriendly border states"

- so the United States accommodated them. (By what logic it could be concluded that slave states would be 'friendly', was never discussed.)

That's what it was called, then - "accommodation". Now, it's called glasnost, and it led to the incredible situation where the "evil empire" Ronald Wilson Reagan recognized the Soviet Union to be in 1980 has become a place where America's children can be sent to be "educated", while Soviet troops leave a bloodbath behind in Afghanistan, and systematic destruction of a generation of the cream of Chinese youth takes place before the eyes of the world through the eyes of media cameras, and the current Resident of the White House deplores the action, while using none of the obvious means the United States possesses to force the Red butchers to alter their course.

Other than detailed reports of murder, mayhem, violence and every kind of perversion, little came out of those Congressional hearings on earlier savage conquests.

The lack of official effort by the United States government to modify its foreign policy, or to search out those in the government who permitted that barbaric invasion of peaceable countries without protest, or even taking steps to prevent future depredations, was - and is - appalling.

It doesn't take an Einstein to know that whatever else our leaders had been doing, they had failed to protect those allies. Lack of policy change in the United States has since condemned other allies to similar fates, and most certainly established culpability in the Tienanmen 'incident'. That culpability is magnified by providing "most favored nation" status on the butchering regime, absent any iota of remorse by them.

The issue of whether or not The People's Republic can be considered an "ally" has not been demonstrated - nor even challenged.

The tragedies of Katanga and the Congo were the epitome of depravity, if there can be a superlative for such a despicable denial of the right to life. The maps of the world have been washed with the blood of martyrs, and redrawn to prepare for the "new world order". Other nations are even now undergoing the bloodbaths which always accompany enslavement.

No need to point out that terrible things are 'happening' in our own country, and the people in our 'government' are not protecting their own citizens, nor even upholding the lawful government. Instead, mechanisms have been put in place to control any possible physical attempt by our people to resist the finalization of control here.

It is expected that the people will attempt to protect the lawful government from those they elect to office who swear to uphold that government, but do not. Some citizens of the United States have been working day and night for more years than they care to remember, spending every dollar they can spare - and some they cannot - trying to combat seemingly overwhelming forces who are now actually working within the

government to deny the freedoms to which every American is entitled.

Other citizens see it coming here, and do nothing. They are "too busy earning a living", or too disgusted with "dirty politics" to get involved.

Let the question be asked of ALL Americans:

"Would you agree with that refugee, cited above, that there's nothing you would not do, to prevent a totalitarian takeover here?"

Raise your right hand, all of you who agree. Um-m-HM! O.K. Now, while you have your hand raised, repeat after me:

"I, ..(yourname).. do solemnly swear that I will, to the best of my ability, preserve, protect and defend the Constitution of the United States, so help me, God."

Some of you may have taken that oath before, if only to yourself and your God. Some of you are already rendering service above and beyond the call of duty, without thought of reward or recognition, other than the preservation and restoration of the Republic.

But what of the millions who have not yet seen the need? What of the officials in our government, who are not doing their bounden duty?

Like those silenced governmental Committees of long ago, it is time for patriots to assess the events of recent years, and, unlike those in government, find some more productive way to approach the problems facing this country - and the world.

Come, let us reason together - and find the ways to motivate those millions who blindly trust where trust is demonstrably not justified, and show them their obligation to duty, honor, country - and their fellowman.

If we fail, there will be no ear to hear our lament.

Addendum:

\*"The Soviet Empire - Prisonhouse of Nations and Races - A Study in Genocide"; Subcommittee of the Senate Judiciary Committee, Investigation of Internal Security, 85th Congress, Doc. # 122, 1958.

"...war is a subject for scholarly study and inquiry, and this study must go far beyond the purely military aspects ... the study of war is as much a matter for the politician, the diplomat, the scientist, and for the professor, as for the professional soldier..."

\*\*\*Karl von Clausewitz.

In a revolutionary situation such as exists today, to Clausewitz' list of those needing such study must be added all those who assume a responsibility for leadership in resistance to the usurpers. If these - who bravely go forth against an undeclared, unidentified, enemy - were versed in the art of war, and fortified with knowledge of strategy and tactics, they would know - and summarily dismiss as diversionary - overly optimistic appraisals of prospects for victory over the mattoids who are promulgating the "Aquarian Conspiracy". Such optimism is unwarranted and self-defeating, since it could result in diminished activity and ardor by some who are not yet fully aware of what is involved in this war we are in.

On the other hand, defeatism is self-fulfilling. To opt out of battle because of a perception of overwhelming odds against a hope of defeating an enemy, guarantees victory for the revolution.

While it is true that ever-increasing numbers of the target population are swelling the ranks of dissent, that very fact demands strong effort to maintain a realistic view of the prospects. These new recruits have, only a dim realization of what is actually going on, and no concept of the totality of the enemy's strength, nor the amount of territory already conquered. In a way, this is good, for if they knew up front how extensive is the enemy's penetration, they might be easily discouraged. Their sights must be kept on the hope which is constantly renewed by the growing resistance. They can not know how pitifully few we have been, and how greatly the prospects have improved as our numbers increase.

It is important that our longterm counter-revolutionaries bear in mind that, regardless of the unlimited dedication and effort, since 1913, when the first major offenses were launched against established governments and voluntary institutions, there has not been a single instance of reversal of captured territory.

The increased restiveness of the citizenry must be attributed to a natural reaction against ever more visible constraints being placed on their liberties. As the revolution reaches the point where a 'transition' is necessary, that visibility will continue to increase, as well.

A continuing strategy of the revolutionaries has been to achieve their goal through the marxian premise "...by peaceful means, if possible; by force and violence, when necessary". Inherent in this strategy is a need for the usurpers to keep resistance at a minimum, until sufficient strength within those institutions is established to assure capability of a successful rout of remnant pockets of the defenders of the status quo.

To achieve that objective, highly sophisticated tactics and tools have been developed - and used - to attain an illusion of "consent" on the part of their intended victims. By such means, "consent" has been achieved. Obtained, as it has been, by deceit, indirection, lies and misrepresentation, it could hardly be considered "voluntary consent". Without freedom to choose, absent subornation, that 'consent' has no standing in law. That fact could be one vulnerable chink in their armor. The citizens must be told that the programs being promoted do not spring from the only valid source for their creation. They must know the

true sources.

The revolutionary plan necessarily included preparation for the time when "consent" would no longer be an option, due to increased visibility of the goal. As that goal comes closer, it can be more easily seen in its true light. The inevitable reaction being witnessed today is to be expected. The increased dissent can be credited to the increasing visibility.

No longer able to pretend that the people are willingly accepting this impossible dream, it can be anticipated that the revolutionaries will find a "need" for the violent phase.

It is imperative that an organized resistance in the United States take advantage of the situation here, while it is still fluid, always keeping focussed on the possibility that not all resistors are motivated by the same purpose. A strategy must be created, which can supply real hope of a reversal of the revolution. It is essential that certain enclaves - long since captured and secured to revolutionary purposes, be retaken. It won't be easy, but nothing worthwhile ever is.

Among these essential footholds are:

- \* the representative offices;
- \* the power of the purse;
- \* all news sources;
- \* education;
- \* the structure of, and the assorted incubators for, The System.
- \* In and through all of these, the penetration of religion is a vital thread.

These necessary bastions are exemplary, neither exclusive nor inclusive. Assaults on any of them requires a clear, untampered mental capability in the resistance.

For example, education includes all areas by means of which conditioning of the mind is accomplished. Counter moves in this area should include giving intelligence of the political reality of "special elections", which are the least noted of the assorted strategies for moving "education" into the NIEO.

The power of the purse, in the same vein, includes the place in which authority rests, as well as the methods of exerting authority. The S&L scandal should be a real bonus here, as the ridiculousities of "deregulation" are exposed, and the resulting transfer of payoff is placed on the overburdened taxpayer.

The news sources have a special vulnerability, due to the existence of that network of reliable "revisionist" reports and papers, such as the Don Bell, Wisconsin, Blumenfeld and Mantooth Reports, and the National Educator, to name a few of the better known. Getting these reliable news outlets into homes all over the country is a priority. It is the best hope for counteracting the disinformation provided by the media.

Here there should also be mention of the considerably fewer "talk shows" which are identifiably supportive of the resistance. We can name only two of these where the Host is undeniably and (self identified as) a 'conservative' American. The John Katz program - probably the longest running 'conservative' talk show in the country - and the Antony Hilder program. John Katz serves the Sacramento, California area, from KTRB, Modesto, 95352, phone (209) 526 8600. Hilder covers Alaska from KEAG, Anchorage 99501, phone (907) 258 9700. There must be more across the country. Find them, and support them. Getting these reliable news outlets into homes all over the country is a must. Advertising support as well as callins are basic needs. There are also many talk shows which encourage



diverse opinion. These should be used.

Penetration of religion has had a major influence in breaking down the moral values which make life worth living. Every encouragement must be given to the valiant adherents of fundamental principles of faith, who have gone against the odds to continue to meet the spiritual needs of mankind. "Traditional" pastors are hard put to keep a congregation unless they adapt to the new age mores. "Adapting" is the equivalent of 'consensus', threatening the integrity of the purpose of the church.

It is a matter of record that potentially rewarding assaults are ongoing on the monetary, regional, and educational fronts. These are far from being retaken at present, but inroads are being made, and the assaults should not be permitted to be relaxed. A major productive assault here is to challenge the validity of 1313 - from its existence to any or all of its projects.

There is no comparable recognition of the importance of the control system, which is the most strategic of all. The structure for The System is the regional front, which has an inherent vulnerability of its own. The visibility of The System is a major priority target. Activation of an assault on 1313 a bonus.

Lacking some substantive progress in the recapture of representation, effective recapture of any of the other bases is problematic at best. The ballot box, with all its ramifications is an essential objective.

These necessary counterattacks are now surrounded by a systematic barrier of protection, which requires a systematic response, and that soon. It is vital that the leaders of the resistance acquire at least a basic understanding of the systems methodology.

The National Educator has proposed a workable method of cooperative effort which offers the most hopeful means of mounting such a systematic attack yet put forward. In the Educator proposal, possible enemy penetration is minimal, and patriotic capabilities are maximized.

Recommended:

CCC Format,  
The National Educator,  
P.O.Box 333,  
Fullerton, California, 92632

Don Bell Report  
P.O.Box 2223  
Palm Beach, Florida, 33480

The Blumenfeld Education Letter  
P.O.Box 45161  
Boise, Idaho 83711

Wisconsin Report  
P.O.Box 45  
Brookfield, Wisconsin 53008

The Mantooth Report  
R Rte 1 Box 387  
Salem, Indiana 47167

The Florida Forum  
P.O.Box 1059  
Highland City, Florida 33846

The Reporter  
P.O.Box 1028  
Placerville, California 95667

" ...the basis for our charges of subversion is the evidence provided by the revisionist historian. Slowly, over decades, book by book (and pamphlet by pamphlet, newsletter by newsletter -ed.) almost line by line, the truth of recent history has emerged..."

Antony Sutton

"Wall Street and the Rise of Hitler"

As we have reported, the disarming of America began in the minds of an identifiable cabal - a long time ago. They were unscrupulous men of wealth, position and power. But that was not enough. Their game was conquest. Their aim, more power. Perhaps they wanted the excitement of the battle. Why play chess, when there is a greater thrill moving live pieces around?

The scheme they devised demanded that all the world's peoples be stripped of any capability to follow their individual dreams or to control their own lives, and, above all, to put up any effective resistance to those who would deny them these basic rights. The only realistic capability for restraints against their Plan lay in America, so their most carefully thought out strategies were aimed at disarming Americans: intellectually, economically, militarily, collectively and individually.

The boldness of their scheme was its best camouflage, for it is beyond the ability of normal people to conceive of such a "gigantic conspiracy, international in scope, conducted with vast resources, indomitable in purpose" and unhampered by accepted standards of morality, integrity, or principle.

The word "normal" is used advisedly, because these men were (and their heirs and assigns are) not normal in any conventional definition of human physiology. They were and are, rather, mattoids, in the classical definition. Before their minions rewrote the dictionaries to serve their revolutionary purposes, a "mattoid" was defined as

"One who exhibits symptoms of mental degeneration, but is not positively insane; a...person whose ideas and aims,... while they may simulate genius, are marked by radical absurdities, which the person is unable...to perceive."

While there is room for argument as to whether these mattoids are able to discern the "radical absurdities" involved in their machinations, there's a plethora of evidence in recent history of instances that no other descriptor would suitably portray. The apparent ease with which their scheme has progressed speaks clearly of the nature of their 'genius'.

The "revisionist historians" (whom Sutton justly credits with providing the truth about recent events) have been able to tear off huge segments of that intrinsic camouflage, permitting accurate evaluations of the deceptive movement it hid for so long. Incrementally, these devoted, volunteer historians have demonstrated the activation of that "gigantic conspiracy", and its sequential programs (assaults). Singly, at first, but, as the evidence grew, uncovering connected strings of interacting stratagems, proof has been bared of a conscious, deliberate attempt to deprive Americans of the means to protect themselves and their government from the planned tyranny now looming large.

With each additional advance, the form of that tyranny is being further revealed. It is like none the world has ever known - a tyranny so total that it threatens to deny forever, to any but the select few, the God-given right to self-determination. There is no apparent recognition among their acolytes that there is no provision for those who aid the revolutionary cause to share in the rewards.

Had it not been for the "revisionist historians", that 'planned tyranny' would have been secured long ago. Armed with the truths provided by the revisionists, Americans can yet bring these mattoids to an accounting and effect a successful counter-revolution.

While we name but one in the frontispiece of this tome, it is really to ALL of these "revisionist historians", that this book is dedicated.

Jo Hindman was selected to represent all that is finest in the heroic mode. Chronicler par excellence of the 1313 movement, Mrs Hindman outdid the whole field of revisionist historians in her constant and comprehensive oversight of the strategies of the regionalists.

From her first exposure of "Terrible 1313" in an article in Mercury Magazine in 1959, she never let up on monitoring the devious machinations by which these scofflaws were usurping the American birthright. The excellence of her work is clearly shown, when the articles she wrote back in the 50s and 60s are read today. The facts she reported then are still valid today. Her posits have all become demonstrated fact, as the work of 1313 has progressed from theory to actuality.

Were it not for the dedicated and competent efforts of Jo Hindman, it is questionable whether Americans would ever have known what 'happened' to their legal government, as the "Metrocrats" performed their transition techniques, deviously changing representation to administration.

Jo was one of the first to recognize 1313 as a movement and became its most implacable foe. Until she began writing articles about it (which numbered in the thousands over the years), those few who had condemned its programs apparently made no connection between them and the groups which promoted them. Nor was there recognition of the interlock between the various 1313 groups. It was Jo's now-famous chart of the Metro network, which she devised in 1959, gave devastating proof of her charge of the gigantic conspiracy involved in 1313 operations.

Jo presented expert testimony to legislative bodies in many areas and at all levels of our government. She frequently appeared on the lecture circuit and talk shows. But she did not stop there. She followed the recommendations she gave to all who sought her advice, graciously responding to every call she received for personal help to understanding, contacting federal, state and local officials, reaching out to neighbors.

In 1973, she spearheaded a Petition to Congress, requesting redress of grievances for the damages done by 1313s beachhead in the federal government, the Advisory Commission on Intergovernmental Relations (ACIR). As each new Congress has convened, this request has been renewed. As of 1990, the Petition has been spurned by "the representatives of the people."

Until the combination of decreasing outlets for her information, age and infirmity became insurmountable obstacles, Jo Hindman was a shining example of all that was best in American womanhood, patriotic devotion and competent journalism.

Jo Hindman was an outstanding reporter and analyst of the current moves of those destroyers. Her life was an exemplar for the rest of today's revisionists; her years of work a yardstick for dedication.

In the beginning, the voices such as Jo's, speaking out against radical incursions, were only sporadic rebuttals to perceived deviations from

custom, tradition, or, on occasion, principle. For most of us, it was years before a pattern could be seen emerging, from which the true nature of the activities of the revolutionary cabal could be extrapolated.

The revisionists saw a need to counter the accumulating fallacies, which the schemers used to shield the truth of their maneuvers. Tirelessly, without regard for self or pelf, these modern seekers of truth have assembled a preponderance of evidence, which proves, beyond a shadow of a doubt, the validity of the charges which, in the past, could only be presumptive.

Consider the courage required to be a lone voice "crying in the wilderness", against entrenched and powerful interests! Yet, to their everlasting credit, there WERE those, even in the beginning, willing to chance the inevitable repercussions which could be expected from, say, a "respected philanthropist" whose hand was caught in the cookie jar! Especially one whose "benefactions" had already garnered the support of 'public opinion'.

In the tradition of Thomas Paine and Patrick Henry, these 20th-century heroes and heroines have met the challenge of their time. Many have spent the best years of their lives in unceasing defense of principle, unending search for truth.

Those "revisionist historians" still living, and those who have, perforce, gone to mingle with their heroic forbears, marched to the same drummer the Pilgrims heard, as they turned their backs on the security of their homelands, in the hope of securing liberty. It was that same magnificent beat which inspired the Declaration of Independence; gave strength to the finger that pulled the trigger on the shot heard round the world; encouraged the ragged remnant of Washington's army at Valley Forge; and gave impetus to the founding of a nation which would operate under God's laws.

Whatever the future holds, all mankind owes a debt to these, as yet unsung, heroes, for that same refrain echoes today in the hearts of all who love liberty.

Should this unholy war against civilization triumph, surely there will always be an echo of the noble resistance remaining in even the befuddled minds of the conquered. Should, God willing, liberty once more be enthroned, all honor will be given to those who held the line while praying for the troops to back them up.

One strategy which holds hope for a storming of the federal beachhead ACIR is the reactivation of Jo Hindman's Petition to Congress. SCORPA has redirected the Petition to State and Local governments, demanding their support for redress of the grievances which ACIR and its ancillary cells have visited on this nation and its people.

As the flags are unfurled on future Fourth's of July, some part of the glory those flags are raised to salute belongs to the valiant efforts of the "revisionist historians", who have continued a tradition of jealously guarding one of the most precious possessions a human can have - a mind unhampered by duress and guile, free to choose its own destiny.

Truth, like liberty, can be lost in a single generation. If future generations are to know liberty, it will stem, in large part, from the truths nourished by the revisionist historians.

Armed with those truths, today's Americans have the tools they need to restore their heritage.

God willing, these will be the heroes of the 21st century!

Addendum:

SCORPA # 289  
1333 Lincoln Street  
Bellingham, Washington  
98226

What of the Future? - 111 - Who is Responsible?  
NOT the Whistleblowers!

One of the questions most frequently raised today is, "What authority has permitted this?"

In these pages are reported some of the events which gave "authority" to this perversion of Federal, State, Local, relations. It would be less than honest, regardless of the most accurate documentation of the official moves which permitted it, to leave it at that.

The whole truth depends on a much larger picture.

Senator Nelson Dilworth (California State R.) was one of the truly great statesmen of this century. He served, with great distinction, for 24 years in the California State Senate.

He was a powerful speaker, and knowledgeable. Because of his 16 years of Chairing of the State Senate Committee on Education, and his service on the California Committee on UnAmerican Activities, there was great demand back in the 50s and 60s for him to share what he learned in those Committees with citizens who were just beginning to realize there was a hidden side to the problems which they were then facing. In his speeches, the Senator delineated the erosions which, even then, were visibly damaging the American heritage, and gave, as his best evaluation, what he deemed to be the core of the problem. He constantly warned against being "too trusting". He said:

"Americans are too apt to credit others with the same moral principles as their own".

and he pointed to the penetration of textbooks in the schools, which even then downgraded American history, government and heroes.

This may be too simplistic for some, but as one who has battled to protect that heritage for over 40 years, I think he touched the central nerve in that one sentence. However, even this is not the whole truth.

The fact is that, lacking a conspiracy to defraud America of her rightful heritage, the public trust would not have been violated. But the public WERE too trusting. The mores of the people who made up these United States were such that "conspiracy" was not something easily accepted as a tool used by any one chosen to conduct "the people's business".

But the record shows that, ever since the concerted assault against this great nation began about the turn of the century, there have been 'voices in the wilderness', warning of a conspiracy which threatened the national security. At first, the warnings applied to men and/or forces outside the government, but as events transpired, the conspirators moved inside, and it became even more difficult to give credence to such charges.

To name a few of the "whistleblowers":

\* as long ago as the 1890s, there was a whistleblower using the unlikely name of "Pierton Dooner" who used fiction to issue his warning. His own introduction to his book "The Last Days of the Republic" is a presumption of fact. Writing in a format which was imitated in the 1940s by the Commission on Educational Policies, "Dooner" wrote of the assault on America as though it were history being viewed from the 1970s. Amazing, how accurate he was, now that the events which transpired in those years ARE history.

\* there was "Ed Browne", who wrote "Socialism or Empire" in 1907, to bring to public attention the assault on transportation - lifeline of a free people - and the portent it held for the future;

\* there were a number of journalists, who exposed the "buying" of United States Senators by the Trusts, and only succeeded in compounding the problem, by bringing about passage of a Constitutional amendment which removed the Senate as the guardian of State interests;

\* there was Methodist Bishop Candler, who, as head of a small southern college, saw the end from the beginning of the assault on the minds of Americans in the penetration of the country's institutions of higher education in 1909;

\* there was Charles Lindbergh, father of the famous aviator, who as a Congressman valiantly fought approval of the Federal Reserve in 1913. Because he knew there was a conspiracy, he saw the threat it held for the future, and he recognized the Fed as a step toward control of the economy of this country;

\* there was the late, great Senator from Oregon, former-Governor George Chamberlain, who, in 1917, recognized the assault on the Federal Executive, spearheaded by men of wealth, whose dollar-a-year agents posed as benefactors as they systematically seized key positions, and used them to diminish popular control of that important Office. The Senator placed his honor, position and reputation on the line to try to obtain recognition by the people of the situation, and he lost his Senate seat as a result;

\* there was radical Upton Sinclair, who documented the takeover of the press, both national and local, by "the Interests", in 1918;

\* there was Chicago socialite, Elizabeth Dilling, who documented the interlock between the "communist" movement and the "elite" in Chicago in 1928;

\* there was liberal educator, Dr William Wirt, who had served the Rockefeller General Education Board for years, and achieved fame and wealth as a result - but threw it all overboard, when he learned what his work was being used for, and HE blew the whistle, in 1933.

\* all through the 30s, the voices decrying the damages being caused by the New Deal proliferated, and, in 1939, three vital voices were raised in protest: Augustin Rudd, and his Guardians of American Education, documenting the assault on the minds of children in the public schools through altered textbooks; George Orwell, emerging from within the Establishment to warn of the inevitable result of continuing policies such as Roosevelt was establishing; and Congressman Samuel Pettingill (D., R.Is.), demonstrating what those policies really were, as opposed to the claims made for them, which he called "Smokescreens";

\* in the mid-40s, there was Governor Ralph Carr of Colorado, who, in his "farewell address to the State Legislature, reported the existence of a Plan to destroy the system of government under which America had grown so great;

\* and Admirals Kimmel, Short and Theobald, revealing the truth about the Japanese attack on Pearl Harbor.

\* there was Frank Hughes, whose investigative reporting for

the Chicago Tribune in midcentury validated Sinclair's' findings of 40 years earlier about "The Prejudice of the Press", and much, much more, including the preparations for a Federation of the World by a group connected with the University of Chicago;

By the time of the 50s, the voices grew exponentially, as more and more Americans began to see the actual evidence of the conspiracy each of these had touched on, and more, beside. And there were giant figures in the American Congress then, who used their great offices to support the oath of allegiance they had taken to protect and defend this country, at great personal risk. And other voices, too:

\* Anne Smart, who lived on Liberty Street in Larchmont, who was the first parent in the country to challenge pornography in textbooks. She sent copies of pages from those texts to all the local officials, protesting their inclusion in school books, and had a visitor from the post office who told her such material could not be sent through the mail!

\* A reporter for a major New York paper wrote his own obituary in the hope of getting what he considered his major life work published. Lowell Limpus had tried every outlet to find a publisher with the courage to print his monumental research on the history of disarmament, without success. Knowing the impact it could have on the course of events he saw developing, he made one last attempt, by placing in his file at the paper an envelope containing his obituary, in which he urged that it be used on the occasion of his death. It began "I died last night...", and was so written as to disguise the true purpose for writing it, but it contained enough information for a friend to recognize Limpus' appeal from the grave, and to be impelled to obtain the manuscript. The friend made it his mission to obtain publication for "DISARM!", and Limpus' warning was printed.

\* And then there was Establishment newsman LLOYD Mallan, who was chosen for his competence and reliability to be the reporter to be sent into the Soviet Union as the channel for propaganda to put Sputnik on the front pages of newspapers around the world. Given free access to all the preparations and actual "launch", Mallan was stunned at what he saw. He returned and found no major outlet would print the truth about the gigantic fraud being perpetrated behind the Iron Curtain to convince the world that the Russian bear had teeth. It was, indeed front page news, but no newspaper would print it. Mallan finally got help from an obscure Fawcett publication, which ran a series of articles he wrote about the scam. Those articles were later published by Fawcett in pamphlet form under the title "RUSSIA and The Big Red Lie", but distribution was limited, and Mallan's findings were dropped down the Memory Hole. No single event has held greater potential for destruction of the carefully constructed scenario of Soviet invincibility than the truth about "Sputnik" on which Mallan attempted to blow the whistle.

By the 60s, a multitude joined in the chorus of protest against the growing evidence of mis- and mal-feasances. But by that time, the Plan had become entrenched in our government, and agents of the conspirators were occupying seats of power.

Who was responsible?

Certainly, the conspirators. Unfortunately, those myriads of Americans too, who didn't hear the whistles blowing, or, hearing, did nothing because they trusted those they had placed in office to protect them. Even before the smokescreens Pettengill described were lowered, and while the majority of Americans still had knowledge of the true nature of their government, some heard those voices - and would not believe.

Who was responsible?

Everybody. And everybody is still responsible today, for that is what these United States are all about.

The whistleblowers can report the moves which are being made to turn the world into a new dark age. They can warn of the danger, and even indicate the reaction which should occur. But everyone is responsible once they possess that knowledge, for what is done about it.

History shows that freedom is not free. Each generation must purchase it anew, if it is to continue.

"Liberty lies in the hearts of men. When it dies there, no power on earth can restore it."\*

Who is responsible for keeping the torch of liberty burning?

YOU.

Addendum:

\*Attributed to Justice Learned Hand - date unknown.



The quiet revolution on the political front must be taken into account.

The Elitists did not have to wait to perfect The System to begin eliminating individual representatives whose personal commitment to their oath of office required them to impose constraints on the progress of The Dream. Even though they were not aware that the things which concerned them had deeper connotations than appeared in the proposals they had to consider, there have always been some representatives who did recognize some of the proposals they were asked to approve were not in the best interests of either the people or the nation.

So ways and means were developed by the revolutionaries to deal with dissent. Tampering with the political system was well under way by the 1950s.

The interventions which paved the way to government by 'experts' instead of government "of, by and for the people"; were already affecting the right to choose. The political "parties" had become conduits for selection of 'desirable' candidates. Provision for large salaries encouraged professional politicians to seek office. Longer and more frequent sessions discouraged local business people from offering to serve. Many more interventions have been added since, but these were already in place. Bypassing the voice of the people in the polling place was never more blatant than the 1960 national election, when Chicago and a precinct in Texas handed the White House to John Kennedy.

Senator Chamberlain may well have been the first to face mayhem at the ballot box. The statement of Congressman O'Connor showed how HE was removed. All through the years, the polling place has been the final arbiter of representation, and that is why it is so important.

It is not enough to find good people to offer for office. They must be protected from first to last, and supported with all the strength and determination which can be mustered. The ratio of politicians vs representatives has been reversed dramatically. The capacity for further depredations has increased incrementally, by virtue of having The System now operative.

As one after another of the representatives in office came under fire, their disenfranchised constituents reached out to the dwindling number of incumbents who still stood firm against the red tide engulfing the legislatures. The mailbags of this remnant must have been filled with letters such as one I wrote to James Utt asking him to represent me, even though I did not live in his district, and could not vote for him. He kindly agreed to be a surrogate, even to the point of having the Congressional Record continued for me, which the Congressman from my District had discontinued.

It was in this manner that John Rarick, a Representative from Louisiana became known as "America's Congressman".

Rarick was a consummate example of the Big Lie about "Republicans" and "Democrats", for he was a man who knew why his Democratic District constituents sent him to Washington four times to represent them. Because he carried his responsibility as a sacred trust, he earned the respect and gratitude of every politically astute American. As the number of his colleagues in the House who also honored their oath of office dwindled, the figure of John Rarick became bigger than life, and Americans turned to him in droves to be their voice in Washington.

How much of the strength John Rarick displayed in office can be credited to the prayers and support of the multitude of disenfranchised citizens who turned to him in desperation cannot be determined. Certainly, without the integrity and moral character he brought to Washington and never compromised, even the tremendous support he received from across the nation could not have made a difference.

One of those who appreciated what John Rarick did in office was Richard Cotten (one of the "revisionist historians", whose 'Conservative Viewpoint' newsletter was part of the "non-news" network). Cotten monitored the final Rarick campaign, and his report of the vicious nature of the strategies used to remove this great American from office is a classic example of a Purge, and a permanent text to use as a basis for counteraction.

In "Viewpoint", Cotten reported that

- \* before the campaign was under way, Rarick was listed as a "target" by AFL/CIO COPE (a PAC - Political Action Committee);

- \* COPE began collecting funds from union members throughout the United States to defeat Rarick and the 15 other Congressmen on the hit list;

- \* Rarick was the only Democrat on the list;

- \* Rarick's "opponent" was a political novice: a sportscaster, whose claim to fame was the remarkable coverage of his campaign which came from two local papers and the local TV station - all which apparently were owned by his former employer, who also owned the largest radio station in the area;

- \* evidence indicated that union business agents spent union funds to "buy votes" in sundry ways;

- \* 5000 registered voters in his district who were considered solid Rarick supporters were 'purged' from the rolls and could not vote. Rolls in the two wards where the organized black vote was strong were not purged;

- \* on election day, organized blacks in uniform clothing set up road blocks, stopping other blacks on the street to be sure they would vote, and escorting them to the polls when necessary;

- \* irregularities occurred at the polls which were never remedied - including strong evidence of fraud.

Cotten wound up his Report with this:

"There can be no question but what a "watergate type" investigation would prove that the election was stolen, not won... we (do not) believe that the media is prepared to go after this 'liberal' element that is doing so much to undermine the very foundations of our society.

"We have evidence of 100% voting in certain precincts, where the possibility of this happening seems non-existent..."

Despite all this, the election was lost by less than 4000 votes out of 117,000 cast. If the 5000 purged votes had been counted, Rarick would have returned to Washington.

What does all this say to YOU?

Does it say that "politics is a dirty business", and that is reason enough to stay out of it?

If so, please let me tell you that when I first started doing precinct work in the 1940s, this was a constant excuse for nonparticipation! The seeds of destruction of the American dream flourish in that soil. Every

American should know that each of them was born to politics, for that is the American way. It is what is meant by "of the people, by the people, and for the people".

What the loss of Congressman Rarick and all those others who have been purged should tell you is that the only answer to such corruption is for all Americans to roll up their sleeves and head these usurpers off at the polls.

For every good American who opts out, there is a politician willing to take his place and roll in the mud. "George" cannot be permitted to do this job. "George" put John Rarick out of office, and, one by one, the remnant will follow, unless "George" is stopped.

Americans must take a page from the enemy scenario, and target every office which is up for grabs.

- \* Probably the first order of business is to recognize that the "art of the possible" demands careful consideration as to which districts are most amenable to challenge. The most hopeful are those in which there is not an incumbent candidate. In every such case, a candidate should be found, and then supported with every ounce of strength which can be mustered. This must be done before systematic subversion closes this avenue.

- \* The carefully constructed bias in favor of incumbents can be counteracted by knowledgeable use of political strategies.

- \* Before the campaigns start, surveys should identify the districts where a successful challenge seems likely.

- \* Funds should be collected for target seats from any source in the country which can be tapped.

- \* Commitments should be obtained from Candidates in the district, and commitments made to them for support.

- \* While some money is always necessary, the obscene amounts now being used are not only not necessary, they can be inhibitory. A pair of shoes with willing feet in them have greater potential than is generally realized. Most of the money which is spent on campaigns goes to ads which mainly only support the kept media. Spent on home production of political information which can be handed out door to door it can have more effect.

- \* Political labels have little meaning today. Both major parties are serving as auxilliary troops to the Elitists in the political arena. Other Party candidates can win, but it is more difficult. If the Candidate is true, ignore the label.

- \* Every facility available should be used to assure reliable vote counting.

Addendum:

"Political Warfare - Conquest through Altered Concept", Duane Thorin, pamphlet, 1963

## WHAT OF THE FUTURE? - 111 - Who's In Charge Here?

The record is clear. De jure, the citizens are in charge. De facto, the revolutionaries are in control.

Described in these pages are some of the processes by which usurpation has taken place. This is by no means the complete record of who has effected this travesty - this grotesquely incongruous imitation of the most progressive government ever to appear in this world. This is not even a full report of the various methods used to create this caricature of a government of liberty under law. In the same vein, you will not find all the answers here.

We are not Delphi. Experience and observation indicate basic methods and means for obtaining redress. We offer suggestions which are a minimum necessity, which can and, with all humility, should be incorporated into all efforts to derail this steamroller on whatever front it is met.

The very strategies and tactics of the revolutionaries present the most indispensable basis for counterattack. Study of enemy moves offers the first principle of a successful offense:

### PRINCIPLE I: CARRY YOUR BANNER HIGH.

Degradation - of person and country - is held by the Enemy to be "the best and foremost weapon" of conquest. And so we have seen a constant defamation of individual and collective character. Patriotism has been smeared and the illusion has been created that it is shameful to be a patriot. Thus:

"Degradation and conquest are companions... degradation can be accomplished more insidiously and more effectively by consistent and continual defamation... Continual and constant degradation of national leaders, national institutions, national practices, and national heroes must be systematically carried out..."\*

And so, we have the smearing of and sneering at everything good and true. It is only natural that those who do not understand what is really 'happening' retreat, become noninvolved, and, in so doing, create an appearance of apathy. Do not buy that canard! Talk to the butcher, the baker, the candlestick maker, the doctor, lawyer, Indian chief. APATHY there? NO WAY.

Be proud of the real heritage of America, and let it be seen. We have the greatest nation the world has ever known, made the target of every tinhorn dictator who can be induced to cooperate with enemy goals. We have Operation Keelhaul; the Pueblo; the Bay of Pigs; the hostages; China, Korea, Vietnam. We have the spectacle of one administration in Washington after another, publicly identifying the Soviet Union as "enemy", and then proceeding to supply that "enemy" with every kind of produce, equipment and technology. What message do these things transmit to the rest of the world?

What else could people in other countries think, except that this is a nation without principle? How sad, that in order to bring out the truth of this revolution, it may sometimes seem that patriots are doing the work of the psychopolitician! But there is a real difference. Patriots are not

attacking the character of the people who are doing these things. They are simply bringing the record of their deeds to public scrutiny.

PRINCIPLE II: HOLD FAST TO ALL THAT IS GOOD AND TRUE.

Character assassination is the province of the genus mattoid. Give no ground for him to stand on:

"By attacking the character and morals of Man himself, and by bringing about, through contamination of youth, a general degraded feeling, command of the populace is facilitated to a very marked degree."\*

And so they began the contamination of our youth. Removal - in the schools - of the knowledge of the tree of good and evil was a bold strategy. Devastatingly threatening to the future, that strategy had innumerable benefits for Enemy's goal - not the least of which was the so-called "generation gap", as parents attempted to compensate for what the schools were teaching, and met a fortified rebellion.

To move from that denial of right and wrong to the pornography which went under the name of "sex education" was a major step into the character and morals of the youth. From the official remedy for the troubles young people had with "progressive education", it was a very short step to the "drug problem" of today.

PRINCIPLE III: KNOW WHAT YOU ARE DEFENDING.

This is vital. Unless you are confident of the parameters of the territory under attack, your attempts to strike at the threat may well backfire.

"There are those who...gave Man to believe that goals should be personally sought and held, and that, indeed, Man's entire impulse toward higher things stemmed from Freedom. We must remember that the same people who embraced this philosophy also continued in Man the myth of spiritual existence..."\*

This is the underlying theme of the revolution, which is being advanced on the premise that Man is an animal, with no unalienable rights; no relationship with his Creator.

PRINCIPLE IV: BEWARE OF FALSE FRIENDS.

"The rich, the skilled...the well informed...are particular and individual targets... Thus every rich man, every statesman, every person well informed and capable in government must have...(at) his side as a trusted confidant...(an) operator."\*

Many Americans have become aware of a force, apparently counter-revolutionary, whose acts almost always aid revolutionary goals. The communists called these the "sleeper aparat". Today they are becoming known as "the new right". They are a fifth column in the ranks of the guardians of the American birthright. They can be individuals or groups,

and their presence is endemic, wherever the battle is joined.

PRINCIPLE V: BE A CONSTANT WITNESS.

The Enemy has created an information vacuum, by presenting to the general public only that 'news' which aids the revolutionary cause, either substantively or by omission. There are still quite a few sources through which the truth can be disseminated. Make the most of these, not just because you need them, nor because they need you, but because they are an essential element in keeping tabs on the progress of the counter-revolution. Some of them have been doggedly holding the fort for years, working for the time when their presence would be vital. That time is now.

But the best witness is still that individual who can stand up in a conflict situation and point out that "The Emperor has no clothes!" - and can give chapter and verse to demonstrate. The truth is the truth, whether or not there is anyone to proclaim it, but that does not mean that anyone will recognize it unless it is identified.

PRINCIPLE VI: BE AWARE OF SYSTEMS CAPABILITY.

"Man is a stimulus-response animal. His entire reasoning capabilities, even his ethics and morals, depend upon stimulus-response machinery. This has long been demonstrated by such Russians as Pavlov, and the principles have been used in handling the recalcitrant, in training children, and in bringing about the optimum behaviour on the part of a population."\*

NO ONE is immune to the machinations of the systemologists. The first order here, is for everyone to be alert to the threat of personal subjection to penetration of the mind. The immediate target for resisters should be building awareness of a planned assault on the mass mind as well as on the individual, and on the course of events.

Knowing how systems work offers the possibility of intervention of a systematic attack in any phase of the war.

PRINCIPLE VII: "THINK GLOBALLY, ACT LOCALLY"

Credit the Metrocrats for this principle, for they coined the phrase, and the strategy based on it. It is one of their strategies which can be adapted to a better cause. It is easy to forget that the massive problems in Washington are from seed planted in our cities and towns. The first steps must be local. We must remember, too, that there is more at stake than our own country. There is little we can do but weep for others, when our country is bleeding to death from mortal wounds. First we must care for our own.

Throughout these pages are scattered the following suggestions (and others!) for action. Please give consideration to all of them, but do not be limited by them. (The numbers are the chapters in which they can be found.)

Most needed now is a flood of new thought on strategies for victory. What is offered here is a stimulant for revitalizing Operation Restoration.

CONCEPT is the key - know your enemy, and how he works

11/25/32 Understanding  
 16 Operation Restoration  
 17 Informing the Public and Representatives  
 18-3/34 exude patriotism  
 20/21/24/31/26/38/44/46/51/52/63 Elect representatives,  
 not politicians or administrators.  
 41/70/71/73/74/75/76/77/78/79/80/81/82/83/84/89/90/91/9  
 2/93/94 recognize evidence of systems subversion, and  
 institute beginning action to nullify its effects  
 21 Include systems strategy in your resistance  
 23 support dependable news outlets  
 24 check Yourstate systems  
 28 Learn the Eisenhower "Goals"; watch for  
 implementation  
 35/55 Be a constant "witness" - both passive and  
 active  
 36/39/54 bone up on political action  
 38 reach out to the younger generation  
 48 encourage citizen participation in their own  
 community affairs  
 56 stop dues to 1313  
 63 interdict activation of COGs  
 65/68 focus public attention on the use and potential  
 of mind direction strategies such as TCD and group  
 dynamics  
 85/86/87/88/89/90/91/92/93/94 examine the true problems  
 with public education, and develop strategies to deal  
 with them at the process level  
 31/96/97/98/99/100/101/102/103/104/105/106 monitor the  
 progress of the "authoritarian state", and identify it  
 to citizens in your community  
 esp.104 recognize the assault on privately held weapons  
 as the ultimate assault on citizen capability for  
 defense of the country

This book is meant as a primer for patriots who mean business about  
 retaking their legitimate authority, and who are willing to reexamine the  
 methods and concepts which have not proven effective, with the aim of  
 initiating more productive forays. Its content should be viewed with that  
 in mind.

Perhaps the message we would most like to leave with you is this - it  
 simply does not 'make sense' that with right, the law, and all of history  
 supporting the patriots, the battles should consistently support the  
 revolutionaries, as has been the case until now. A position MUST be found  
 which will provide a theater to reverse that process.

An offensive is needed which will support a fresh approach to the  
 problems created by this unrelenting assault. This will require the best  
 minds in the field to be applied to new strategies for victory.

It requires massive recruitment of that army of disinformed citizens,  
 to a cause they can recognize as being in their interest.

It requires a willingness for our battle-scarred veterans to gird  
 themselves for taking charge of a revitalized, equally unrelenting,  
 determination to win back our country, our liberties, and our future.

Addendum:

"Synthesis on Psychopolitics" Stickley, 1959

Be advised that your reporter makes no claim to be an expert on anything except dogged determination. Circumstances put me in places where things happened, and something had to be done. Things were done - by a great many fine, caring Americans. Clearly, it has not been enough. If it had been, this book would have been simply a history of the most ambitious power grab the world has ever known. Instead of that, it must be a Call to arms targetting all men and women of good will.

The handwriting is on the wall.

Unless there is a reversal of the progress of this revolution - and that soon - the end will be (as George Orwell warned) a boot - stamping on a human face - forever.

To achieve that reversal is going to require some rethinking on the part of all who value their own freedom and the marvelous civilization which resulted from the production of "the greatest work ever struck off by the hand of man" - our lawful government.

In view of the documented record of perfidy through which the world has been brought to its present condition, among the first concerns must be evaluation of the avenues which are open to remedies - and those which demonstrably are not, at this time.

A first priority is recognition that among the top targets of the revolutionaries are the individual and collective minds of every human being. We hope that this report has lifted the curtain which has hidden the most pernicious weapon of war yet devised - the capability of controlling a population through directing the thought process of an entire nation of people. Whatever strategies are devised for redress, that one premise must be made a part of any program.

With that as a given, let us briefly examine some of the gambits which have been ongoing, and some of the remedies which have been nonproductive.

One overweening threat is the pandemic use of drugs. The so-called "drug war" does not - cannot - solve this problem. There has been almost NO effort to determine why all at once there has been such general acceptance of drugs.

Why has there not been such effort?

Why is the single purportedly "corrective" measure confined to hitting at the suppliers of the drugs? Is it the side benefit of capability to confiscate private property without resorting to lawful grant? Or is it something far more sinister than that?

Systematic control of the mind is most effective when the use of drugs is included. The absence of any mention of this fact in discussions of use of mind altering drugs is significant.

Many years ago, facilities were constructed to permit additions to the water supplies of every community. The proposed addition of fluoride was an immediate trigger of controversy, strongly resisted. Despite unanswered questions of the possible ill effects involved in ingesting fluorides, most communities in this country succumbed to the pressure, and provided the avenue for additives. This, despite the fact that it was pointed out then that fluorides were shipped as a "hazardous substance", used as rat poison, and had certain unresolved questionable effects. Recently, pressure has begun to force fluoride on those communities which had not succumbed to earlier attempts. One has to ask "Why?" Is it possible, as was charged forty years ago, that the facility is the real reason for the pressure? Is there a plan for other additives? Does fluoride, itself, contain a mind-altering property?



In the 1950s, a new childhood disease was announced. "Hyperactivity". The remedy? Drugs. Specifically one called ritalin. Ritalin has since been proven addictive. Teachers were unable to control the reaction of the children to the modern "education" methods, so thousands - perhaps tens of thousands - of children were started on drugs. Our younger son was so diagnosed, and it was recommended that he be drugged. Our remedy? Private school. Cure, immediate.

In the late 50s, an ivy league professor toured the country inducting college-age youngsters into the psychedelic world by using lysergic acid. There were immediate tragedies, and some longterm damage. Our older son was one victim. A promising life was irretrievably damaged - and his was only one of many. No corrective measures were taken about the professor for this crime.

In the early 60s, hundreds of babies were born damaged - minus an arm, leg, or with other deformity. A prescription drug given to the expectant mother, approved by a federal regulatory agency, was found to be the cause.

In the 60s, the flower children made drugs a way of life. Their children are the now generation. Are their numbers swarming with victims unable to adhere to principle due to brains addled by their mothers having used during pregnancy?

Who can read the sad statistics of this present generation of teens, and not ask "WHY?"

Why so much supine acceptance of patently wrongful activities on the part of such a large congerie of American youth? Why such disregard of principle? Why such a horrendous number of suicides? Or any of the other life-damaging modes? Could it be the removal of the understanding of good and evil from the children who entered the government schools, beginning in the 40s?

Making that determination could hold the answer to "the drug problem".

We have covered the matter of sexual deviance in the section "Suffer, little children". It also ties into the good/evil syndrome.

Any attempt at correction in these areas must begin with 'cause' as a base of remedy.

Constants in the assault on the mind include race and religion. Both these have been made trigger areas for a majority of the population, who will react adversely to any charge against either. In the reality of the present, any attempt to use either of these as a base for corrective measures is doomed before it starts.

Inclusion of religious precepts is a basic need for any attempt at corrective action. The warning here must be to make sure that those precepts are tried and true. In religion, as in politics, all is not gold that glitters. Denial of fundamentalism is a large part of today's problems, and you can bet it was planned that way!

Perhaps the least effective battle which has been engaged in this counter-revolution has been the attempt to use the tactics of the civil rights movement (crm) to achieve an objective. It must be remembered that, not only does the crm have a "friend in court" (since it serves the revolutionary cause), but the ground rules have been altered to permit the crm to bypass constitutional and legal restraints.

Neither of these encouragements exist for the counter-revolution.

As a result, the authoritarian state has picked off some of our most effective and dedicated troops who rushed in to use a proven method of achieving a goal, who did not realize that they would face a different set of rules. Many of these now languish in the gulag, watching the titanic struggle, instead of lending their strength and competence to it.

The judicial system needs attention, but at this time, the best that can be done is to avoid when possible any activity which is sure to lead to being subject to Court attention.

The Supreme Court is still in that role of a tool for global conquest. Watch for the use of flag-burning as a trigger to obtain a constitutional convention, or at least a modification of the first amendment. Any such modification can only weaken further the protection of the Bill of Rights. So, too, with the Second Amendment. Watch for State pre-emption of the gun 'protection' in the Second. Some States have already entered on this gambit.

For the political situation: This is where the most needed work must be done. Admittedly, it is now in such a shambles that it is difficult to see how any hope still exists of using the ballot box. We can only remind you of a ww2 slogan which had merit then, but is today almost a mandate. "The difficult we do immediately. The impossible will take a little longer."

There are still a great many Americanists in office at every level. The priority here is to contact each and every one of these, and encourage them to hold the line. Let these know there is help on the way, and offer to back them on every move they make which fortifies the lawful government. This is where the National Educator's CCC we mentioned earlier can be the catalyst for action.

Each and every one of the Americans who have demonstrated their loyalty to the lawful government and are now holding office, should be briefed on the information about psychopolitics. The best representative can be rendered ineffective by one aide or other trusted staff member dedicated to neutering the incumbent.

It would be unrealistic and counterproductive to attempt at one swell foop to replace every elected official who negates grassroots encouragement to fulfill the oath sworn on taking office, desirable as that eventuality would be.

Politics is the art of the possible. Certain seats at every election are up for grabs, and those should be targetted. When a candidate is found for any of those, he/she should find troops from all over the country behind their candidacy, with everything they need to gain the seat. This is one enemy strategy which can safely be adapted to the counter revolution. PACs (Political Action Committees) pour millions into campaigns in which they have no direct interest. This is a function similar to that of the IRR, which can be made to serve either cause, but it can be a two-edged sword. Use with caution.

The stats currently show a staggering financial bonus to incumbents - 56 millions vs. 3 millions to challengers. Do not be disheartened by the money question, though. Far more important is the ancient art of personal contact with the electorate. Those who cannot send money can provide shoe leather and feet to fill the shoes. Those who can send money can back up the bodies who walk the precincts.

For specific penetrations which have longrange impact, there is an over-riding need to examine alternative methods of approaching those problems. Clearly, the history of this resistance has shown that past attempts to stop the termites eating away at the foundations of our total heritage have had no substantive success. My evaluation suggests that there must be a direct attack on either the source of the problem, or the process by which it is sustained - or both. For instance, two immediate sources come to mind - the United Nations and 1313. Almost every concern which touches American problems can be traced to one or the other of these

sources, possibly to both, and from them, back to a primary source - the "foundations".

Until the complexion of the United States Senate can be altered, there is an element of futility in any method which can be devised to do anything directly about the UN. Any proposal which could hold a hope that this is erroneous should be welcomed and supported. As this record of perfidy is being put to bed, it is just possible that such a hope has been created. It depends on how it is used.

This is in reference to "The Crisis in the Gulf", as the media terms it. Every patriotic American who has done the homework required to understand what is really 'happening' in world events knows what a false edifice the United Nations is. Outside this relatively small parameter there is a huge disinformed public who have assimilated the propaganda about "the only hope for peace". Here is a clear case by which to test, for them, the value of the United Nations.

A general penetration nationwide of the smokescreen of propaganda about the UN would certainly find a response among these. Talk shows, letters to the editor, and confrontations with office-seeking candidates in public places, could form a base for further assault.

There is an element of sheer danger involved in this "crisis". The rapidity with which events are moving toward the revolutionary Goal carries suggestion of a possibility of an attempt to finallize the transfer of power in the United States. The removal from American soil of such a large contingent of ablebodied men and women could make a real difference in such an event. Monitor this situation carefully, even while you continue to fight back on the home front.

The 1313 situation is quite different. There is already in place a library full of evidence that 1313 is vulnerable, and that there are major ways to cripple the process of 1313 activism. This is important, not just because there is no revolutionary move which does not reveal the 1313 involvement, and because it is through 1313 that many of the UN dicta are brought into the mainstream of American life. Important reenforcements are daily entering the resistance on this front, as 1313 activity impacts their lives.

Jo Hindman was right on so many things, but never more so than when she identified ACIR (1313s "legitimate" arm) as "the UN Cell". This being so, it should follow that every successful interdiction of 1313 also strikes a blow at any present penetration, and at the UN, as well.

It is not our purpose here to lay out a complete blueprint for action. Our purpose is to stimulate a fresh approach to regaining sovereignty.

If we have done that, we have met our goal. So, with this, we leave you to make your decisions in the present crisis.

May the good Lord have mercy on us all, and lead us in this, the ultimate struggle for His kingdom.



# AMERICA

## Cannot Be Conquered

"AMERICA" is not a country. It is not a Flag. It is not a parchment Statement of Principles. It is not a Constitution. It is not Republicans nor Democrats, nor Parties, nor politicians. It is not mountains, nor plains, nor alabaster cities, nor rural crossroads.

AMERICA is a dream. It is the spark in the heart of man which burns the brightest when the cold draughts of tyranny fan the flame.

AMERICA is the embodiment of Everyman's yearning to be free.

AMERICA is the child-heart struggling to grow - to be the man or woman promised at conception.

AMERICA is the culmination of the centuries-long confrontation by Man with the mortal limitations of his earthy being. It is the upward reach of humanity.

AMERICA is the intangible reflection of the human potential; of virtue unashamed; of truth, unspoiled.

AMERICA is the possibility of wealth - not just the riches of silver and gold, but of mental, spiritual and emotional wealth; of songs too beautiful for words, of poetry which gives reason to language; of the wealth unplumbed in the questioning mind, and the unbounded achievement of an individuals impossible dreams.

AMERICA is courage - limitless, unfettered courage. It is that special attribute which allows Man to conquer his own frailties, and rise above his physical constraints.

AMERICA is all that is best in Everyman - his hopes, his dreams, his love, his tenderness, his abilities, his warmth, his strengths, his honor.

Little men may pervert a Party, corrupt a politician, burn a Flag, tear up a parchment, ravage a treasured heritage, lay barren a countryside, destroy a country - but no earthly power can conquer the heart and soul of Man, nor ever rout the Dream.